

User's Manual

16-Port SFP + 8-Port Combo GbE L2 Plus Managed Switch
Release 1.45

Table of Contents

CAUTION.....	VI
ELECTRONIC EMISSION NOTICES	VI
1. INTRODUCTION.....	2
1-1. OVERVIEW OF GEFXL2P-SW24	2
1-2. CHECKLIST	5
1-3. FEATURES	5
1-4. VIEW OF GEFXL2P-SW24.....	7
1-4-1. User Interfaces on the Front Panel (Button, LEDs and Plugs)	7
1-4-2. AC Power Input on the Rear Panel.....	8
1-5. VIEW OF THE OPTIONAL MODULES.....	8
2. INSTALLATION.....	9
2-1. STARTING GEFXL2P-SW24 UP	9
2-1-1. Hardware and Cable Installation	9
2-1-2. Installing Chassis to a 19-Inch Wiring Closet Rail.....	11
2-1-3. Cabling Requirements.....	11
2-1-3-1. Cabling Requirements for TP Ports.....	11
2-1-3-2. Cabling Requirements for 1000SX/LX SFP Module.....	11
2-1-3-3. Switch Cascading in Topology	13
2-1-4. Configuring the Management Agent of GEFXL2P-SW24.....	16
2-1-4-1. Configuring the Management Agent of GEFXL2P-SW24 through the Serial RS-232 Port	17
2-1-4-2. Configuring the Management Agent of GEFXL2P-SW24 through the Ethernet Port	19
2-1-5. IP Address Assignment.....	20
2-2. TYPICAL APPLICATIONS	25
3. OPERATION OF WEB-BASED MANAGEMENT.....	27
3-1. WEB MANAGEMENT HOME OVERVIEW.....	28
3-1-1. System Information	31
3-1-2. Account Configuration.....	33
3-1-3. Time Configuration.....	33
3-1-4. IP Configuration.....	36
3-1-5. Loop Detection.....	39
3-1-6. Management Policy	40
3-1-7. System log	43
3-1-8. Virtual Stack.....	44
3-2. PORT CONFIGURATION	46
3-2-1. Port Configuration.....	47
3-2-2. Port Status.....	49
3-2-3. Simple Counter	52
3-2-4. Detail Counter	54
3-2-5. Power Saving.....	57
3-3. VLAN	58
3-3-1. VLAN Mode.....	58
3-3-2. Tag-based Group.....	61
3-3-3. Port-based Group	63
3-3-4. Ports.....	65
3-3-5. Port Isolation.....	67
3-3-6. Management	68
3-4. MAC	69

3-4-1. Mac Address Table	69
3-4-2. Static Filter	71
3-4-3. Static Forward	72
3-4-4. MAC Alias.....	73
3-4-5. MAC Table	74
3-5. GVRP.....	75
3-5-1. Config	75
3-5-2. Counter.....	78
3-5-3. Group.....	80
3-6. QoS(QUALITY OF SERVICE) CONFIGURATION	81
3-6-1. Ports.....	81
3-6-2. Qos Control List.....	83
3-6-3. Rate Limiters.....	89
3-6-4. Storm Control.....	91
3-6-5. Wizard.....	92
3-7. SNMP CONFIGURATION.....	102
3-8. ACL.....	104
3-8-1. Ports.....	104
3-8-2. Rate Limiters.....	106
3-8-3. Access Control List	107
3-8-4. Wizard	135
3-9. IP MAC BINDING	145
3-9-1. IP MAC Binding Configuration	145
3-9-2. IP MAC BINDING DYNAMIC ENTRY	147
3-10. 802.1X CONFIGURATION.....	148
3-10-1. Server.....	153
3-10-2. Port Configuration.....	155
3-10-3. Status.....	158
3-10-4. Statistics	159
3-11. TRUNKING CONFIGURATION.....	160
3-11-1. Port	162
3-11-2. Aggregator View.....	164
3-11-3. ACP System Priority.....	165
3-12. STP CONFIGURATION.....	166
3-12-1. Status.....	166
3-12-2. Configuration.....	168
3-12-3. STP Port Configuration.....	170
3-13. MSTP	173
3-13-1. Status.....	173
3-13-2. Region Config	174
3-13-3. Instance View	175
3-14. MIRROR	183
3-15. MULTICAST.....	184
3-15-1. IGMP Mode	184
3-15-2. IGMP Proxy.....	186
3-15-3. Snooping	188
3-15-4. Group Membership	189
3-15-5. MVR.....	190
3-15-6. MVID	191
3-15-7. Group Allow.....	192
3-15-8. MVR Group Membership	193
3-16. ALARM CONFIGURATION	194
3-16-1. Events.....	195
3-16-2. Email.....	196

3-17. DHCP SNOOPING.....	197
3-17-1. DHCP Snooping State.....	197
3-17-2. DHCP Snooping Entry.....	198
3-17-3. DHCP Snooping Client.....	199
3-18. LLDP.....	200
3-18-1 . LLDP State.....	200
3-18-2 . LLDP Entry.....	202
3-18-3 . LLDP Statistics	204
3-19. SAVE/ RESTORE.....	206
3-19-1. Factory Defaults	207
3-19-2 . Save Start	207
3-19-3 . Save User.....	207
3-19-4 . Restore User	208
3-20. EXPORT/ IMPORT	209
3-21. DIAGNOSTICS.....	210
3-21-1 . Diag	210
3-21-2 .Ping.....	211
3-22 MAINTENANCE	212
3-22-1 .Reset Device.....	212
3-22-2 .Software Upload	212
3-23 LOGOUT.....	213
4. OPERATION OF CLI MANAGEMENT.....	214
4-1. CLI MANAGEMENT.....	214
4-1-1. Login.....	214
4-2. COMMANDS OF CLI	216
4-2-1. Global Commands of CLI.....	217
4-2-2. Local Commands of CLI.....	223
5. MAINTENANCE.....	309
5-1. RESOLVING NO LINK CONDITION	309
5-2. Q&A.....	309
APPENDIX A TECHNICAL SPECIFICATIONS	310
APPENDIX B NULL MODEM CABLE SPECIFICATIONS	313

Revision History

Release	Date	Revision
0.91	2008/03/03	A1
0.95	2008/06/25	A2
0.95	2008/07/21	A2
1.01	2008/10/01	A3
1.27	2009/03/17	A4
1.27	2009/05/25	A5
1.43	2009/08/03	A6
1.45	2009/09/14	A7

Caution

Circuit devices are sensitive to static electricity, which can damage their delicate electronics. Dry weather conditions or walking across a carpeted floor may cause you to acquire a static electrical charge.

To protect your device, always:

- Touch the metal chassis of your computer to ground the static electrical charge before you pick up the circuit device.
- Pick up the device by holding it on the left and right edges only.
- If you need using outdoor device connect to this device with cable then you need to addition an arrester on the cable between outdoor device and this device.

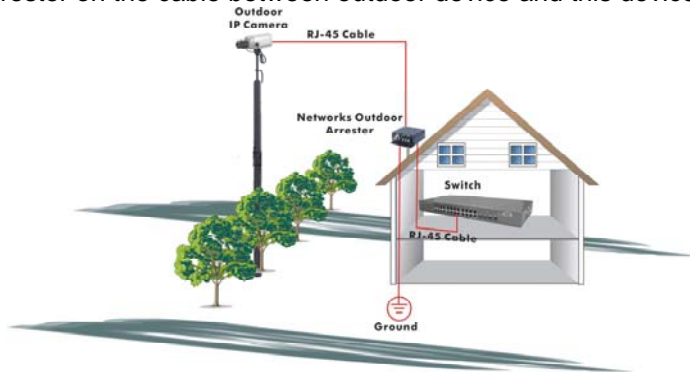

Fig. Addition an arrester between outdoor device and this switch

Electronic Emission Notices

Federal Communications Commission (FCC) Statement

This equipment has been tested and found to comply with the limits for a class A computing device pursuant to Subpart J of part 15 of FCC Rules, which are designed to provide reasonable protection against such interference when operated in a commercial environment.

European Community (CE) Electromagnetic Compatibility Directive

This equipment has been tested and found to comply with the protection requirements of European Emission Standard [EN55022/EN61000-3](#) and the Generic European Immunity Standard EN55024.

EMC:

EN55022(2003)/CISPR-2(2002)	class A
IEC61000-4-2(2001)	4K V CD, 8KV, AD
IEC61000-4-3(2002)	3V/m
IEC61000-4-4(2001)	1KV – (power line), 0.5KV – (signal line)

About this user's manual

In this user's manual, it will not only tell you how to install and connect your network system but configure and monitor the GEFXL2P-SW24 through the built-in CLI and web by RS-232 serial interface and Ethernet ports step-by-step. Many explanation in detail of hardware and software functions are shown as well as the examples of the operation for web-based interface and command-line interface (CLI).

Overview of this user's manual

- Chapter 1 "Introduction" describes the features of GEFXL2P-SW24
- Chapter 2 "Installation"
- Chapter 3 "Operation of Web-based Management"
- Chapter 4 "Operation of CLI Management"
- Chapter 5 "Maintenance"

1. Introduction

1-1. Overview of GEFXL2P-SW24

GEFXL2P-SW24, a 24-port Gigabit L2 Plus Managed Switch, is a standard switch that meets all IEEE 802.3/u/x/z Gigabit, Fast Ethernet specifications. 16-Port 1000Mbps SFP and 8-Port Combo Gigabit TP/SFP Fiber dual media management Ethernet switch. The switch can be managed through RS-232 serial port via directly connection, or through Ethernet port using CLI or Web-based management unit, associated with SNMP agent. With the SNMP agent, the network administrator can logon the switch to monitor, configure and control each port's activity in a friendly way. The overall network management is enhanced and the network efficiency is also improved to accommodate high bandwidth applications. In addition, the switch features comprehensive and useful functions such as QoS (Quality of Service), Spanning Tree, VLAN, Port Trunking, Bandwidth Control, Port Security, SNMP/RMON, IGMP Snooping capability via the intelligent software. It is suitable for both metro-LAN and office applications.

Others the switch increase support the Power saving for reduce the power consumption with "ActiPHY Power Management" and "PerfectReach Power Management" two technique. It could efficient saving the switch power with auto detect the client idle and cable length to provide different power.

In this switch, Port 1 and Port 8 include two types of media --- TP and SFP Fiber (LC, BiDi LC...); this port supports 10/100/1000Mbps TP or 1000Mbps SFP Fiber with auto-detected function. 1000Mbps SFP Fiber transceiver is used for high-speed connection expansion.

- 1000Mbps LC, Multi-Mode, SFP Fiber transceiver
- 1000Mbps LC, 10km, SFP Fiber transceiver
- 1000Mbps LC, 30km, SFP Fiber transceiver
- 1000Mbps LC, 50km, SFP Fiber transceiver
- 1000Mbps BiDi LC, 20km, 1550nm SFP Fiber WDM transceiver
- 1000Mbps BiDi LC, 20km, 1310nm SFP Fiber WDM transceiver

10/100/1000Mbps TP is a standard Ethernet port that meets all IEEE 802.3/u/x/z Gigabit, Fast Ethernet specifications. 1000Mbps SFP Fiber transceiver is a Gigabit Ethernet port that fully complies with all IEEE 802.3z and 1000Base-SX/LX standards.

1000Mbps Single Fiber WDM (BiDi) transceiver is designed with an optic Wavelength Division Multiplexing (WDM) technology that transports bi-directional full duplex signal over a single fiber simultaneously.

For upgrading firmware, please refer to the Section 3-21 or Section 4-2-2 for more details. The switch will not stop operating while upgrading firmware and after that, the configuration keeps unchanged.

Note:

The switch was for using indoor purpose, if it was used in outdoor environment or connect with cable to outdoor then it must to use a lightning arrester to protect the switch.

• Key Features in the Device

QoS:

Support Quality of Service by the IEEE 802.1P standard. There are two priority queue and packet transmission schedule.

Spanning Tree:

Support IEEE 802.1D, IEEE 802.1w (RSTP: Rapid Spanning Tree Protocol) standards.

VLAN:

Support Port-based VLAN and IEEE802.1Q Tag VLAN. Support 256 active VLANs and VLAN ID 1~4094.

Port Trunking:

Support static port trunking and port trunking with IEEE 802.3ad LACP.

Bandwidth Control:

Support ingress and egress per port bandwidth control.

Port Security:

Support allowed, denied forwarding and port security with MAC address.

SNMP/RMON:

SNMP agent and RMON MIB. In the device, SNMP agent is a client software which is operating over SNMP protocol used to receive the command from SNMP manager (server site) and echo the corresponded data, i.e. MIB object. Besides, SNMP agent will actively issue TRAP information when happened.

RMON is the abbreviation of Remote Network Monitoring and is a branch of the SNMP MIB.

The device supports MIB-2 (RFC 1213), Bridge MIB (RFC 1493), RMON MIB (RFC 1757)-statistics Group 1,2,3,9, Ethernet-like MIB (RFC 1643), Ethernet MIB (RFC 1643) and so on.

IGMP Snooping:

Support IGMP version 2 (RFC 2236): The function IGMP snooping is used to establish the multicast groups to forward the multicast packet to the member ports, and, in nature, avoid wasting the bandwidth while IP multicast packets are running over the network.

IGMP Proxy:

The implementation of IP multicast processing. The switch supports IGMP version 1 and IGMP version 2, efficient use of network bandwidth, and fast response time for channel changing. IGMP version 1 (IGMPv1) is described in RFC1112 ,and IGMP version 2 (IGMPv2) is described in RFC 2236. Hosts interact with the system through the exchange of IGMP messages. Similarly, when you configure IGMP proxy, the system interacts with the router on its upstream interface through the exchange of IGMP messages. However, when acting as the proxy, the system performs the host portion of the IGMP task on the upstream interface as follows:

- When queried, sends group membership reports to the group.
- When one of its hosts joins a multicast address group to which none of its other hosts belong, sends unsolicited group membership reports to that group.

- When the last of its hosts in a particular multicast group leaves the group, sends an unsolicited leave group membership report to the all-routers group (244.0.0.2).

DHCP Snooping:

This feature enables the DHCP Snooping to include information about client when forwarding DHCP requests from a DHCP client to a DHCP server via Trust Port. DHCP snooping can be configured on LAN switches to harden the security on the LAN to only allow clients with specific IP/MAC addresses to have access to the network. In short, DHCP snooping ensures IP integrity on a Layer 2 switched domain.

Power Saving:

The Power saving using the "ActiPHY Power Management" and "PerfectReach Power Management" two techniques to detect the client idle and cable length automatically and provides the different power. It could efficient to save the switch power and reduce the power consumption.

Q-in-Q VLAN for performance & security:

The VLAN feature in the switch offers the benefits of both security and performance. VLAN is used to isolate traffic between different users and thus provides better security. Limiting the broadcast traffic to within the same VLAN broadcast domain also enhances performance. Q-in-Q, the use of double VLAN tags is an efficient method for enabling Subscriber Aggregation. This is very useful in the MAN.

Link Layer Discovery Protocol (LLDP)

IEEE Standard——802.1AB (Link Layer Discovery Protocol) , Provide more easy debug tool and enhance the networking management availability, Others it can provide auto-discovery device and topology providing.

MVR:

Multicast VLAN Registration (MVR) can support carrier to serve content provider using multicast for Video streaming application in the network. Each content provider Video streaming has a dedicated multicast VLAN. The MVR routes packets received in a multicast source VLAN to one or more receive VLANs. Clients are in the receive VLANs and the multicast server is in the source VLAN.

Access Control List (ACL):

The ACLs are divided into EtherTypes. IPv4, ARP protocol, MAC and VLAN parameters etc. Here we will just go over the standard and extended access lists for TCP/IP. As you create ACEs for ingress classification, you can assign a policy for each port, the policy number is 1-8, however, each policy can be applied to any port. This makes it very easy to determine what type of ACL policy you will be working with.

IP-MAC-Port Binding:

The IP network layer uses a four-byte address. The Ethernet link layer uses a six-byte MAC address. Binding these two address types together allows the transmission of data between the layers. The primary purpose of IP-MAC binding is to restrict the access to a switch to a number of authorized users. Only the authorized client can access the Switch's port by checking the pair of IP-MAC Addresses and port number with the pre-configured database. If an unauthorized user tries to access an IP-MAC binding enabled port, the system will block the access by dropping its packet.

1-2. Checklist

Before you start installing the switch, verify that the package contains the following:

- GEFXL2P-SW24 24-port Layer 2 plus Gigabit Managed Switch
- SFP Modules (optional)
- Mounting Accessory (for 19" Rack Shelf)
- This User's Manual in CD-ROM
- AC Power Cord
- RS-232 Cable

Please notify your sales representative immediately if any of the aforementioned items is missing or damaged.

1-3. Features

The GEFXL2P-SW24, a standalone off-the-shelf switch, provides the comprehensive features listed below for users to perform system network administration and efficiently and securely serve your network.

• Hardware

- 16 SFP Fiber ports
- 8 10/100/1000Mbps TP or 1000Mbps SFP Fiber dual media auto sense
- 1392KB on-chip frame buffer
- Support jumbo frame up to 9K bytes
- Programmable classifier for QoS (Layer 4/Multimedia)
- 8K MAC address and 4K VLAN support (IEEE802.1Q)
- Per-port shaping, policing, and Broadcast Storm Control
- Power Saving with "ActiPHY Power Management" and "PerfectReach Power Management" techniques.
- IEEE802.1Q Q-in-Q nested VLAN support
- Full-duplex flow control (IEEE 802.3x) and half-duplex backpressure
- Extensive front-panel diagnostic LEDs; System: Power, TP Port1-8: LINK/ACT, 10/100/1000Mbps, SFP Port 1-24: SFP(LINK/ACT)

• Management

- Supports concisely the status of port and easily port configuration
- Supports per port traffic monitoring counters
- Supports a snapshot of the system Information when you login
- Supports port mirror function
- Supports the static trunk function

- Supports 802.1Q VLAN
- Supports user management and limits three users to login
- Maximal packet length can be up to 9600 bytes for jumbo frame application
- Supports DHCP Broadcasting Suppression to avoid network suspended or crashed
- Supports Link Layer Discovery Protocol (LLDP)
- Supports to send the trap event while monitored events happened
- Supports default configuration which can be restored to overwrite the current configuration which is working on via web browser and CLI
- Supports on-line plug/unplug SFP modules
- Supports Quality of Service (QoS) for real time applications based on the information taken from Layer 2 to Layer 4, such as VoIP
- Built-in web-based management and CLI management, providing a more convenient UI for the user
- Supports port mirror function with ingress/egress traffic
- Supports rapid spanning tree (802.1w RSTP)
- Supports multiple spanning tree (802.1s MSTP)
- Supports 802.1X port security on a VLAN
- Supports IP-MAC-Port Binding for LAN security
- Supports user management and only first login administrator can configure the device. The rest of users can only view the switch
- SNMP access can be disabled and prevent from illegal SNMP access
- Supports Ingress, Non-unicast and Egress Bandwidth rating management with a resolution of 1Mbps
- The trap event and alarm message can be transferred via e-mail
- Supports diagnostics to let administrator knowing the hardware status
- Supports loop detection to protect the switch crash when the networking has looping issue
- HTTP and TFTP for firmware upgrade, system log upload and configuration file import/export
- Supports remote boot the device through user interface and SNMP
- Supports NTP network time synchronization and daylight saving
- Supports 120 event log records in the main memory and display on the local console

1-4. View of GEFXL2P-SW24



Fig. 1-1 Full View of GEFXL2P-SW24

1-4-1. User Interfaces on the Front Panel (Button, LEDs and Plugs)

There are 8 TP Gigabit Ethernet ports and 24 SFP fiber ports for optional removable modules on the front panel of the switch. LED display area, locating on the left side of the panel, contains a Power LED, which indicates the power status and 24 ports working status of the switch. One RS-232 DB-9 interface is offered for configuration or management.

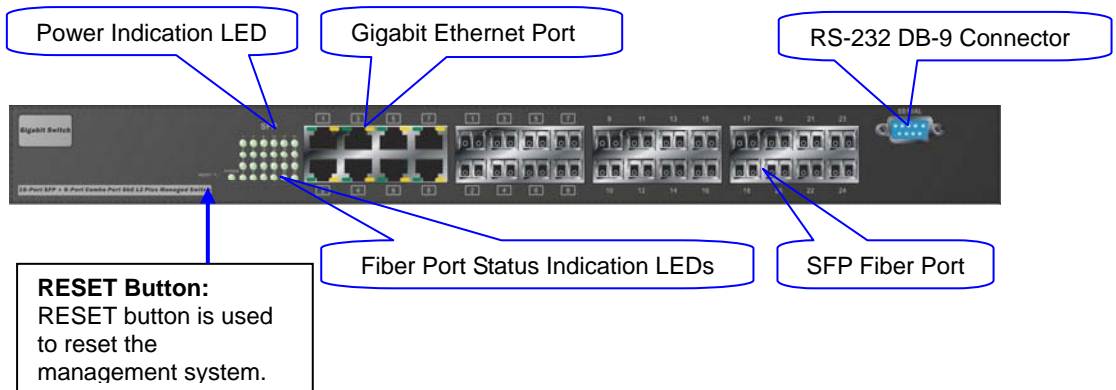

Fig. 1-2 Front View of GEFXL2P-SW24

- LED Indicators

LED	Color	Function
System LED		
POWER	Green	Lit when +5V DC power is on and good
10/100/1000Ethernet TP Port 1 to 8 LED		
LINK/ACT	Green	Lit when connection with remote device is good Blinks when any traffic is present Off when cable connection is not good
10/100/1000Mbps	Green/ Amber	Lit green when 1000Mbps speed is active Lit amber when 100Mbps speed is active Off when 10Mbps speed is active
1000SX/LX Gigabit Fiber Port 1, 24 LED		
SFP(LINK/ACT)	Green	Lit when connection with the remote device is good Blinks when any traffic is present Off when module connection is not good

Table1-1

1-4-2. AC Power Input on the Rear Panel

One socket on the rear panel is for AC power input.



Fig. 1-3 Rear View of GEFXL2P-SW24

1-5. View of the Optional Modules

In the switch, Port 1~ 8 includes two types of media --- TP and SFP Fiber (LC, BiDi LC...); this port supports 10/100/1000Mbps TP or 1000Mbps SFP Fiber with auto-detected function. 1000Mbps SFP Fiber transceiver is used for high-speed connection expansion; the following are optional SFP types provided for the switch:

- 1000Mbps LC, MM, SFP Fiber transceiver
- 1000Mbps LC, SM 10km, SFP Fiber transceiver
- 1000Mbps LC, SM 30km, SFP Fiber transceiver
- 1000Mbps LC, SM 50km, SFP Fiber transceiver
- 1000Mbps BiDi LC, type 1, SM 20km, SFP Fiber WDM transceiver
- 1000Mbps BiDi LC, type 2, SM 20km, SFP Fiber WDM transceiver
- 1000Mbps LC, SM 10km, SFP Fiber transceiver with DDM



Fig. 1-4 Front View of 1000Base-SX/LX LC, SFP Fiber Transceiver



Fig. 1-5 Front View of 1000Base-LX BiDi LC, SFP Fiber Transceiver

2. Installation

2-1. Starting GEFXL2P-SW24 Up

This section will give users a quick start for:

- Hardware and Cable Installation
- Management Station Installation
- Software booting and configuration

2-1-1. Hardware and Cable Installation

At the beginning, please do first:

- ⇒ Wear a grounding device to avoid the damage from electrostatic discharge
- ⇒ Be sure that power switch is OFF before you insert the power cord to power source

- **Installing Optional SFP Fiber Transceivers to the GEFXL2P-SW24**

Note: If you have no modules, please skip this section.

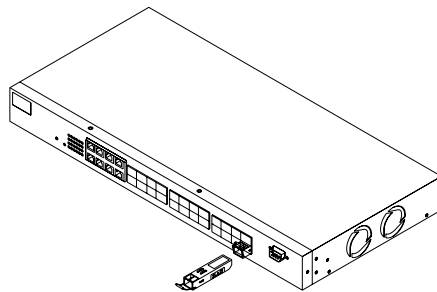

Fig. 2-1 Installation of Optional SFP Fiber Transceiver

- **Connecting the SFP Module to the Chassis:**

The optional SFP modules are hot swappable, so you can plug or unplug it before or after powering on.

1. Verify that the SFP module is the right model and conforms to the chassis
2. Slide the module along the slot. Also be sure that the module is properly seated against the slot socket/connector
3. Install the media cable for network connection
4. Repeat the above steps, as needed, for each module to be installed into slot(s)
5. Have the power ON after the above procedures are done

Note:

The switch supports the SFP Vendor includes: Manufacture, Agilent, Avago and Finisa

- **TP Port and Cable Installation**

- ⇒ In the switch, TP port supports MDI/MDI-X auto-crossover, so both types of cable, straight-through and crossed-over can be used. It means you do not have to tell from them, just plug it.
- ⇒ Use Cat. 5 grade RJ-45 TP cable to connect to a TP port of the switch and the other end is connected to a network-aware device such as a workstation or a server.
- ⇒ Repeat the above steps, as needed, for each RJ-45 port to be connected to a Gigabit 10/100/1000 TP device.

Now, you can start having the switch in operation.

- **Power On**

The switch supports 100-240 VAC, 50-60 Hz power supply. The power supply will automatically convert the local AC power source to DC power. It does not matter whether any connection plugged into the switch or not when power on, even modules as well. After the power is on, all LED indicators will light up immediately and then all off except the power LED still keeps on. This represents a reset of the system.

- **Firmware Loading**

After resetting, the bootloader will load the firmware into the memory. It will take about 30 seconds, after that, the switch will flash all the LED once and automatically performs self-test and is in ready state.

2-1-2. Installing Chassis to a 19-Inch Wiring Closet Rail

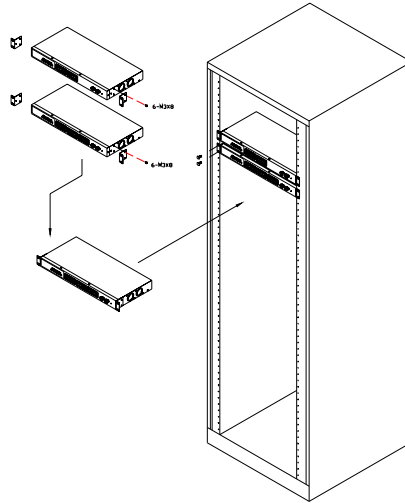

Fig. 2-2

Caution: Allow a proper spacing and proper air ventilation for the cooling fan at both sides of the chassis.

- ⇒ Wear a grounding device for electrostatic discharge.
- ⇒ Screw the mounting accessory to the front side of the switch (See Fig. 2-2).
- ⇒ Place the Chassis into the 19-inch wiring closet rail and locate it at the proper position. Then, fix the Chassis by screwing it.

2-1-3. Cabling Requirements

To help ensure a successful installation and keep the network performance good, please take a care on the cabling requirement. Cables with worse specification will render the LAN to work poorly.

2-1-3-1. Cabling Requirements for TP Ports

- ⇒ For Fast Ethernet TP network connection
 - The grade of the cable must be Cat. 5 or Cat. 5e with a maximum length of 100 meters.
- ⇒ Gigabit Ethernet TP network connection
 - The grade of the cable must be Cat. 5 or Cat. 5e with a maximum length of 100 meters. Cat. 5e is recommended.

2-1-3-2. Cabling Requirements for 1000SX/LX SFP Module

It is more complex and comprehensive contrast to TP cabling in the fiber media. Basically, there are two categories of fiber, multi mode (MM) and single mode (SM). The later is categorized into several classes by the distance it supports. They are SX, LX, LHX, XD, and ZX. From the viewpoint of connector type, there mainly are LC and BIDI LC.

- Gigabit Fiber with multi-mode LC SFP module

- Gigabit Fiber with single-mode LC SFP module
- Gigabit Fiber with BiDi LC 1310nm SFP module
- Gigabit Fiber with BiDi LC 1550nm SFP module

The following table lists the types of fiber that we support and those else not listed here are available upon request.

IEEE 802.3z Gigabit Ethernet 1000SX 850nm	Multi-mode Fiber Cable and Modal Bandwidth			
	Multi-mode 62.5/125μm		Multi-mode 50/125μm	
	Modal Bandwidth	Distance	Modal Bandwidth	Distance
	160MHz-Km	220m	400MHz-Km	500m
	200MHz-Km	275m	500MHz-Km	550m
1000Base- LX/LHX/XD/ZX	Single-mode Fiber 9/125μm			
	Single-mode transceiver 1310nm 10Km			
	Single-mode transceiver 1550nm 30, 50Km			
1000Base-LX Single Fiber (BIDI LC)	Single-Mode *20Km		TX(Transmit)	1310nm
			RX(Receive)	1550nm
	Single-Mode *20Km		TX(Transmit)	1550nm
			RX(Receive)	1310nm

Table2-1

2-1-3-3. Switch Cascading in Topology

- **Takes the Delay Time into Account**

Theoretically, the switch partitions the collision domain for each port in switch cascading that you may up-link the switches unlimitedly. In practice, the network extension (cascading levels & overall diameter) must follow the constraint of the IEEE 802.3/802.3u/802.3z and other 802.1 series protocol specifications, in which the limitations are the timing requirement from physical signals defined by 802.3 series specification of Media Access Control (MAC) and PHY, and timer from some OSI layer 2 protocols such as 802.1d, 802.1q, LACP and so on.

The fiber, TP cables and devices' bit-time delay (round trip) are as follows:

1000Base-X TP, Fiber		100Base-TX TP		100Base-FX Fiber	
Round trip Delay: 4096		Round trip Delay: 512			
Cat. 5 TP Wire:	11.12/m	Cat. 5 TP Wire:	1.12/m	Fiber Cable:	1.0/m
Fiber Cable :	10.10/m	TP to fiber Converter: 56			
Bit Time unit : 1ns (1sec./1000 Mega bit)		Bit Time unit: 0.01 μ s (1sec./100 Mega bit)			

Table 2-2

Sum up all elements' bit-time delay and the overall bit-time delay of wires/devices must be within Round Trip Delay (bit times) in a half-duplex network segment (collision domain). For full-duplex operation, this will not be applied. You may use the TP-Fiber module to extend the TP node distance over fiber optic and provide the long haul connection.

- **Typical Network Topology in Deployment**

A hierarchical network with minimum levels of switch may reduce the timing delay between server and client station. Basically, with this approach, it will minimize the number of switches in any one path; will lower the possibility of network loop and will improve network efficiency. If more than two switches are connected in the same network, select one switch as Level 1 switch and connect all other switches to it at Level 2. Server/Host is recommended to connect to the Level 1 switch. This is general if no VLAN or other special requirements are applied.

Case1: All switch ports are in the same local area network. Every port can access each other (See Fig. 2-3).

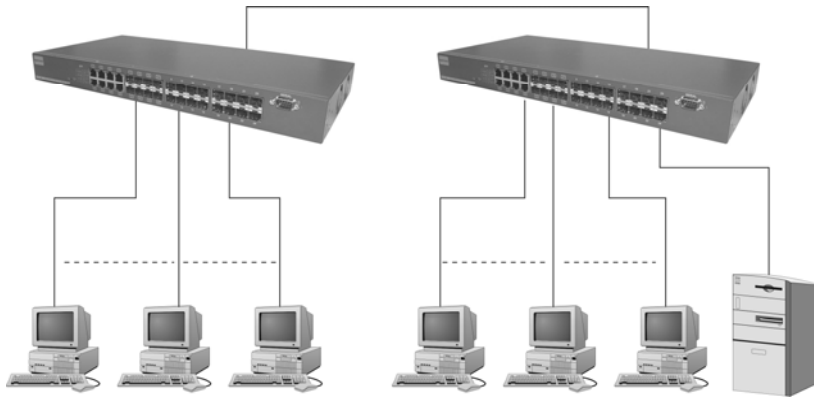

Fig. 2-3 No VLAN Configuration Diagram

If VLAN is enabled and configured, each node in the network that can communicate each other directly is bounded in the same VLAN area.

Here VLAN area is defined by what VLAN you are using. The switch supports both port-based VLAN and tag-based VLAN. They are different in practical deployment, especially in physical location. The following diagram shows how it works and what the difference they are.

Case2a: Port-based VLAN (See Fig.2-4).

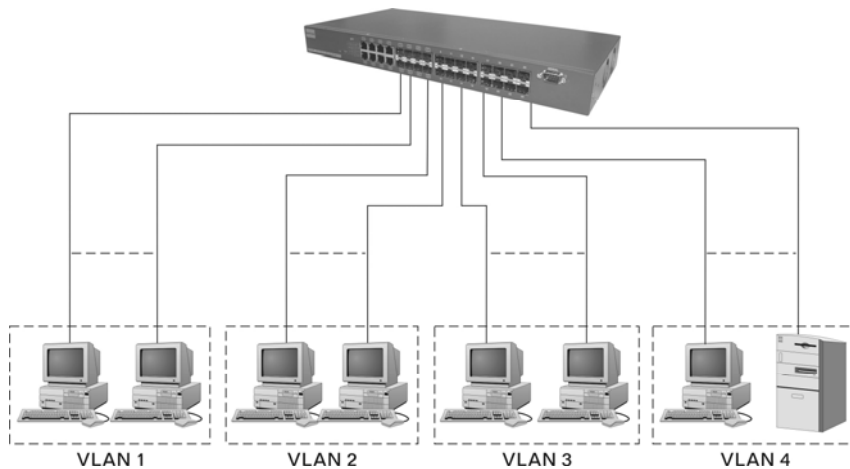

Fig. 2-4 Port-based VLAN Diagram

1. The same VLAN members could not be in different switches.
2. Every VLAN members could not access VLAN members each other.
3. The switch manager has to assign different names for each VLAN groups at one switch.

Case 2b: Port-based VLAN (See Fig.2-5).

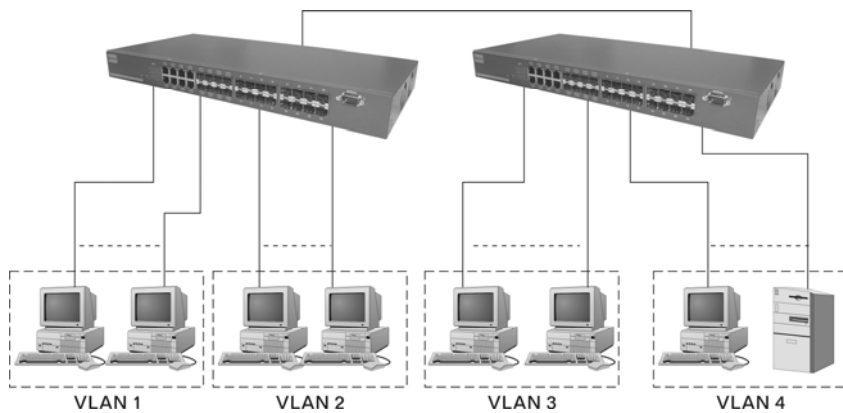

Fig. 2-5 Port-based VLAN Diagram

1. VLAN1 members could not access VLAN2, VLAN3 and VLAN4 members.
2. VLAN2 members could not access VLAN1 and VLAN3 members, but they could access VLAN4 members.
3. VLAN3 members could not access VLAN1, VLAN2 and VLAN4.
4. VLAN4 members could not access VLAN1 and VLAN3 members, but they could access VLAN2 members.

Case3a: The same VLAN members can be at different switches with the same VID (See Fig. 2-6).

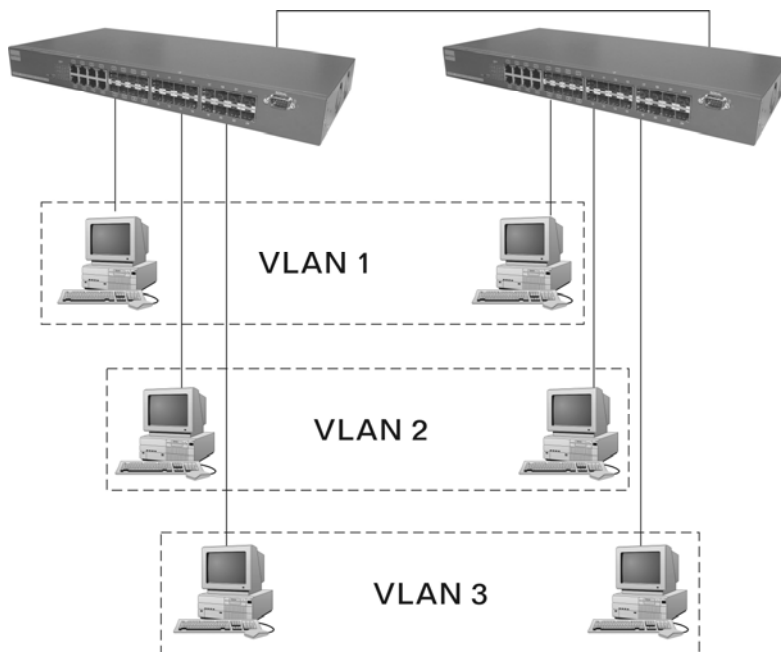

Fig. 2-6 Attribute-based VLAN Diagram

2-1-4. Configuring the Management Agent of GEFXL2P-SW24

We offer you three ways to startup the switch management function. They are RS-232 console, CLI, and Web. Users can use any one of them to monitor and configure the switch. You can touch them through the following procedures.

Section 2-1-4-1: Configuring the Management Agent of GEFXL2P-SW24 through the Serial RS-232 Port

Section 2-1-4-2: Configuring the Management Agent of GEFXL2P-SW24 through the Ethernet Port

Note: Please first modify the IP address, Subnet mask, Default gateway and DNS through RS-232 console, and then do the next.

2-1-4-1. Configuring the Management Agent of GEFXL2P-SW24 through the Serial RS-232 Port

To perform the configuration through RS-232 console port, the switch's serial port must be directly connected to a DCE device, for example, a PC, through RS-232 cable with DB-9 connector. Next, run a terminal emulator with the default setting of the switch's serial port. With this, you can communicate with the switch.

In the switch, RS-232 interface only supports baud rate 115200 bps with 8 data bits, 1 stop bit, no parity check and no flow control.

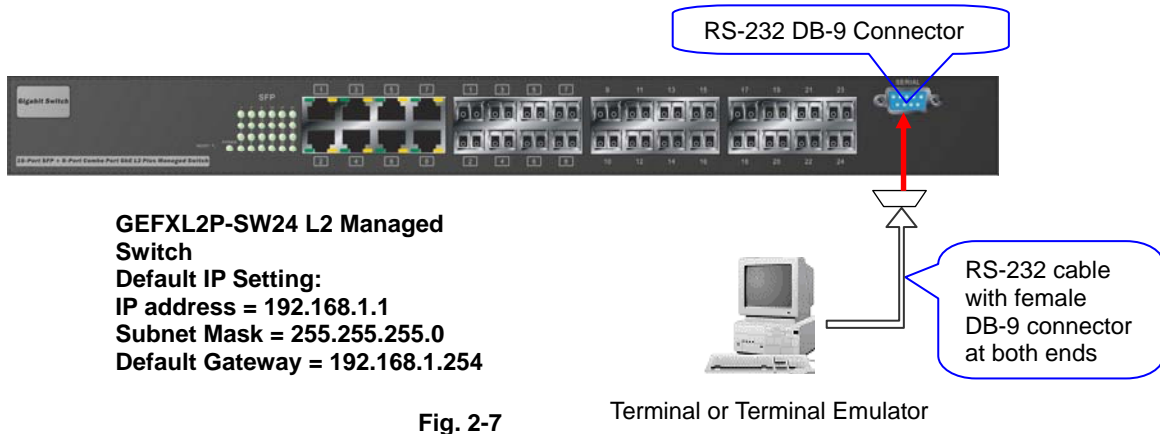

Fig. 2-7

To configure the switch, please follow the procedures below:

1. Find the RS-232 DB-9 cable with female DB-9 connector bundled. Normally, it just uses pins 2, 3 and 7. See also Appendix B for more details on Null Modem Cable Specifications.
2. Attaches the DB-9 female cable connector to the male serial RS-232 DB-9 connector on the switch.
3. Attaches the other end of the serial RS-232 DB-9 cable to PC's serial port, running a terminal emulator supporting VT100/ANSI terminal with The switch's serial port default settings. For example, Windows98/2000/XP HyperTerminal utility.

Note: The switch's serial port default settings are listed as follows:

Baud rate	115200
Stop bits	1
Data bits	8
Parity	N
Flow control	none

4. When you complete the connection, then press **<Enter>** key. The login prompt will be shown on the screen. The default username and password are shown as below:

Username = admin

Password = admin

- **Set IP Address, Subnet Mask and Default Gateway IP Address**

Please refer to Fig. 2-7 CLI Management for details about ex-factory IP setting. They are default setting of IP address. You can first either configure your PC IP address or change IP address of the switch, next to change the IP address of default gateway and subnet mask.

For example, your network address is 10.1.1.0, and subnet mask is 255.255.255.0. You can change the switch's default IP address 192.168.1.1 to 10.1.1.1 and set the subnet mask to be 255.255.255.0. Then, choose your default gateway, may be it is 10.1.1.254.

Default Value	GEFXL2P-SW24	Your Network Setting
IP Address	192.168.1.1	10.1.1.1
Subnet	255.255.255.0	255.255.255.0
Default Gateway	192.168.1.254	10.1.1.254

Table 2-3

After completing these settings in the switch, it will reboot to have the configuration taken effect. After this step, you can operate the management through the network, no matter it is from a web browser or Network Management System (NMS).

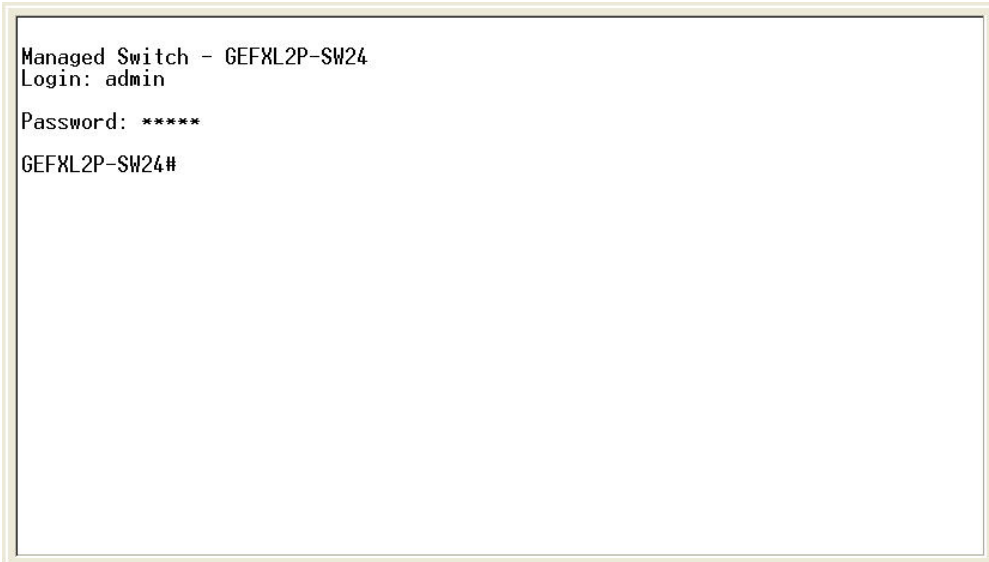

Fig. 2-8 the Login Screen for CLI

2-1-4-2. Configuring the Management Agent of GEFXL2P-SW24 through the Ethernet Port

There are three ways to configure and monitor the switch through the switch's Ethernet port. They are CLI, Web browser and SNMP manager. The user interface for the last one is NMS dependent and does not cover here. We just introduce the first two types of management interface.

GEFXL2P-SW24 L2 Managed Switch

Default IP Setting:

IP = 192.168.1.1

Subnet Mask = 255.255.255.0

Default Gateway = 192.168.1.254

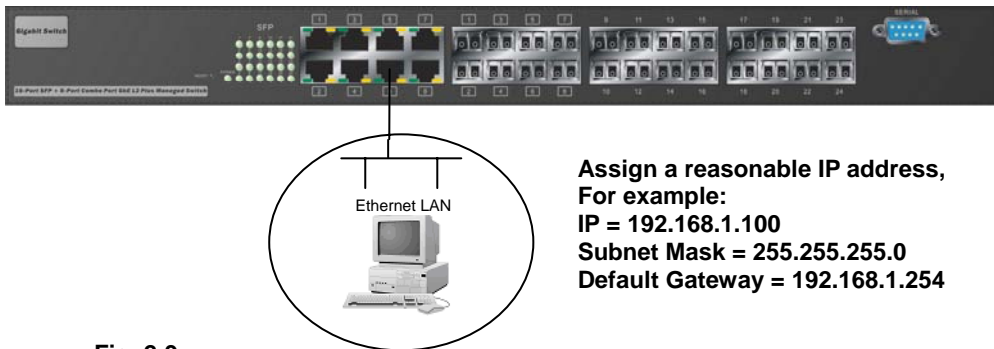

Fig. 2-9

• Managing GEFXL2P-SW24 through Ethernet Port

Before you communicate with the switch, you have to finish first the configuration of the IP address or to know the IP address of the switch. Then, follow the procedures listed below.

1. Set up a physical path between the configured the switch and a PC by a qualified UTP Cat. 5 cable with RJ-45 connector.

Note: If PC directly connects to the switch, you have to setup the same subnet mask between them. But, subnet mask may be different for the PC in the remote site. Please refer to Fig. 2-9 about the switch's default IP address information.

2. Run CLI or web browser and follow the menu. Please refer to Chapter 3 and Chapter 4.

Please Input Username & Password

Username:

Password:

[Forget Password?](#)

Fig. 2-10 the Login Screen for Web

2-1-5. IP Address Assignment

For IP address configuration, there are three parameters needed to be filled in. They are IP address, Subnet Mask, Default Gateway and DNS.

IP address:

The address of the network device in the network is used for internetworking communication. Its address structure looks is shown in the Fig. 2-11. It is “classful” because it is split into predefined address classes or categories.

Each class has its own network range between the network identifier and host identifier in the 32 bits address. Each IP address comprises two parts: network identifier (address) and host identifier (address). The former indicates the network where the addressed host resides, and the latter indicates the individual host in the network which the address of host refers to. And the host identifier must be unique in the same LAN. Here the term of IP address we used is version 4, known as IPv4.

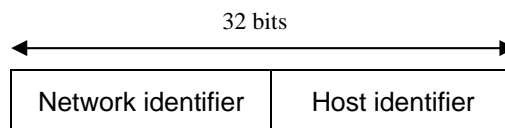
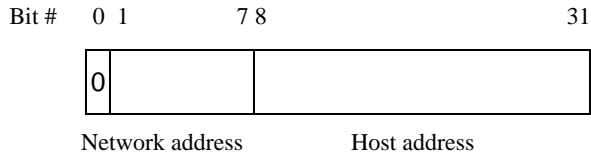

Fig. 2-11 IP address structure

With the classful addressing, it divides IP address into three classes, class A, class B and class C. The rest of IP addresses are for multicast and broadcast. The bit length of the network prefix is the same as that of the subnet mask and is denoted as IP address/X, for example, 192.168.1.0/24. Each class has its address range described below.

Class A:

Address is less than 126.255.255.255. There are a total of 126 networks can be defined because the address 0.0.0.0 is reserved for default route and 127.0.0.0/8 is reserved for loopback function.



Class B:

IP address range between 128.0.0.0 and 191.255.255.255. Each class B network has a 16-bit network prefix followed 16-bit host address. There are 16,384 (2^{14})/16 networks able to be defined with a maximum of 65534 ($2^{16} - 2$) hosts per network.

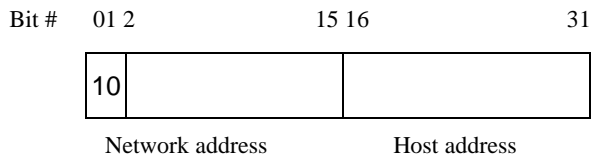

Class C:

IP address range between 192.0.0.0 and 223.255.255.255. Each class C network has a 24-bit network prefix followed 8-bit host address. There are 2,097,152 (2^{21})/24 networks able to be defined with a maximum of 254 ($2^8 - 2$) hosts per network.

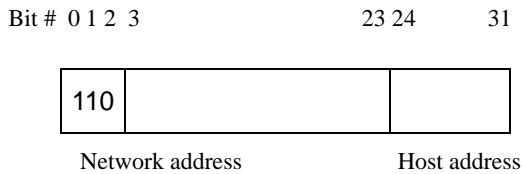

Class D and E:

Class D is a class with first 4 MSB (Most significance bit) set to 1-1-1-0 and is used for IP Multicast. See also RFC 1112. Class E is a class with first 4 MSB set to 1-1-1-1 and is used for IP broadcast.

According to IANA (Internet Assigned Numbers Authority), there are three specific IP address blocks reserved and able to be used for extending internal network. We call it Private IP address and list below:

Class A	10.0.0.0 --- 10.255.255.255
Class B	172.16.0.0 --- 172.31.255.255
Class C	192.168.0.0 --- 192.168.255.255

Please refer to RFC 1597 and RFC 1466 for more information.

Subnet mask:

It means the sub-division of a class-based network or a CIDR block. The subnet is used to determine how to split an IP address to the network prefix and the host address in bitwise basis. It is designed to utilize IP address more efficiently and ease to manage IP network.

For a class B network, 128.1.2.3, it may have a subnet mask 255.255.0.0 in default, in which the first two bytes is with all 1s. This means more than 60 thousands of nodes in flat IP address will be at the same network. It's too large to manage practically. Now if we divide it into smaller network by extending network prefix from 16 bits to, say 24 bits, that's using its third byte to subnet this class B network. Now it has a subnet mask 255.255.255.0, in which each bit of the first three bytes is 1. It's now clear that the first two bytes is used to identify the class B network, the third byte is used to identify the subnet within this class B network and, of course, the last byte is the host number.

Not all IP address is available in the sub-netted network. Two special addresses are reserved. They are the addresses with all zero's and all one's host number. For example, an IP address 128.1.2.128, what IP address reserved will be looked like? All 0s mean the network itself, and all 1s mean IP broadcast.

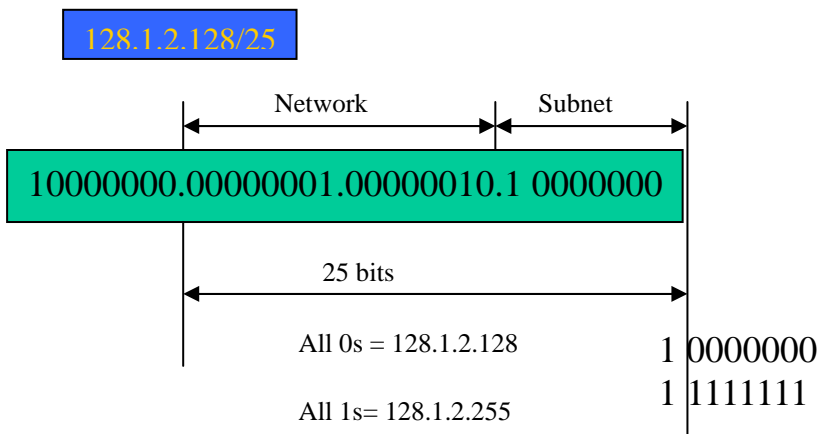

In this diagram, you can see the subnet mask with 25-bit long, 255.255.255.128, contains 126 members in the sub-netted network. Another is that the length of network prefix equals the number of the bit with 1s in that subnet mask. With this, you can easily count the number of IP addresses matched. The following table shows the result.

Prefix Length	No. of IP matched	No. of Addressable IP
/32	1	-

/31	2	-
/30	4	2
/29	8	6
/28	16	14
/27	32	30
/26	64	62
/25	128	126
/24	256	254
/23	512	510
/22	1024	1022
/21	2048	2046
/20	4096	4094
/19	8192	8190
/18	16384	16382
/17	32768	32766
/16	65536	65534

Table 2-4

According to the scheme above, a subnet mask 255.255.255.0 will partition a network with the class C. It means there will have a maximum of 254 effective nodes existed in this sub-netted network and is considered a physical network in an autonomous network. So it owns a network IP address which may looks like 168.1.2.0.

With the subnet mask, a bigger network can be cut into small pieces of network. If we want to have more than two independent networks in a worknet, a partition to the network must be performed. In this case, subnet mask must be applied.

For different network applications, the subnet mask may look like 255.255.255.240. This means it is a small network accommodating a maximum of 15 nodes in the network.

Default gateway:

For the routed packet, if the destination is not in the routing table, all the traffic is put into the device with the designated IP address, known as default router. Basically, it is a routing policy. The gateway setting is used for Trap Events Host only in the switch.

For assigning an IP address to the switch, you just have to check what the IP address of the network will be connected with the switch. Use the same network address and append your host address to it.

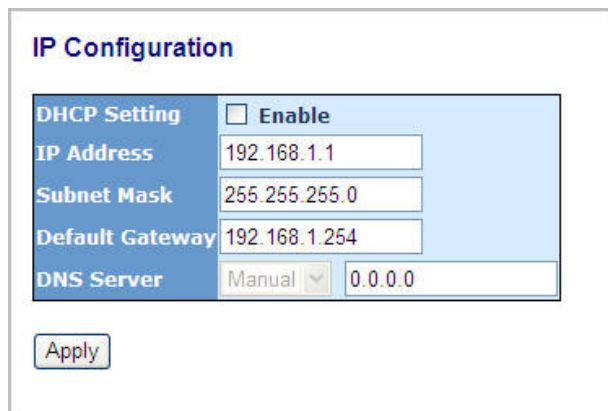

The image shows a window titled "IP Configuration" with a blue header. Inside, there is a table-like structure with a blue header row. The first row is "DHCP Setting" with a checkbox labeled "Enable" that is unchecked. The second row is "IP Address" with a text box containing "192.168.1.1". The third row is "Subnet Mask" with a text box containing "255.255.255.0". The fourth row is "Default Gateway" with a text box containing "192.168.1.254". The fifth row is "DNS Server" with a dropdown menu set to "Manual" and a text box containing "0.0.0.0". Below the table is an "Apply" button.

IP Configuration	
DHCP Setting	<input type="checkbox"/> Enable
IP Address	192.168.1.1
Subnet Mask	255.255.255.0
Default Gateway	192.168.1.254
DNS Server	Manual 0.0.0.0

Apply

Fig. 2-12

First, IP Address: as shown in the Fig. 2-12, enter "192.168.1.1", for instance. For sure, an IP address such as 192.168.1.x must be set on your PC.

Second, Subnet Mask: as shown in the Fig. 2-12, enter "255.255.255.0". Any subnet mask such as 255.255.255.x is allowable in this case.

DNS:

The Domain Name Server translates human readable machine name to IP address. Every machine on the Internet has a unique IP address. A server generally has a static IP address. To connect to a server, the client needs to know the IP of the server. However, user generally uses the name to connect to the server. Thus, the switch DNS client program (such as a browser) will ask the DNS to resolve the IP address of the named server.

2-2. Typical Applications

The GEFXL2P-SW24 implements 8 Gigabit Ethernet TP ports with auto MDIX and two slots for the removable module supporting comprehensive fiber types of connection, including LC and BiDi-LC SFP modules. For more details on the specification of the switch, please refer to Appendix A.

The switch is suitable for the following applications.

- Central Site/Remote site application is used in carrier or ISP (See Fig. 2-13)
- Peer-to-peer application is used in two remote offices (See Fig. 2-14)
- Office network(See Fig. 2-15)

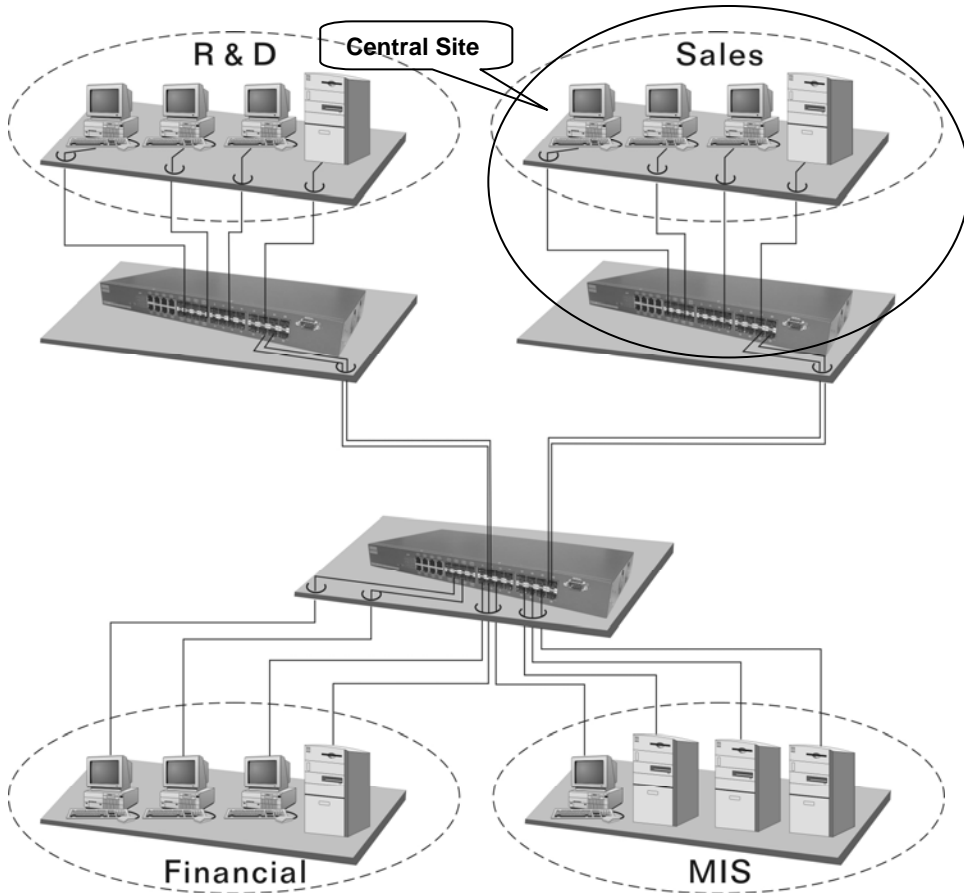

Fig. 2-13 Network Connection between Remote Site and Central Site

Fig. 2-13 is a system wide basic reference connection diagram. This diagram demonstrates how the switch connects with other network devices and hosts.

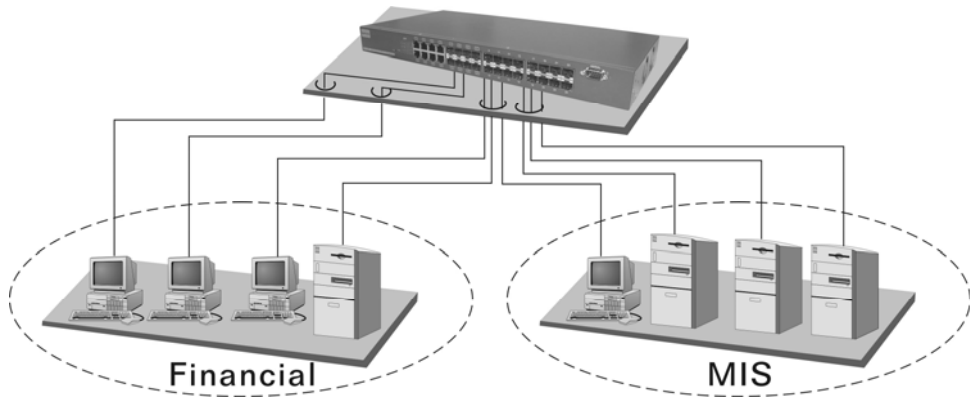

Fig. 2-14 Peer-to-peer Network Connection

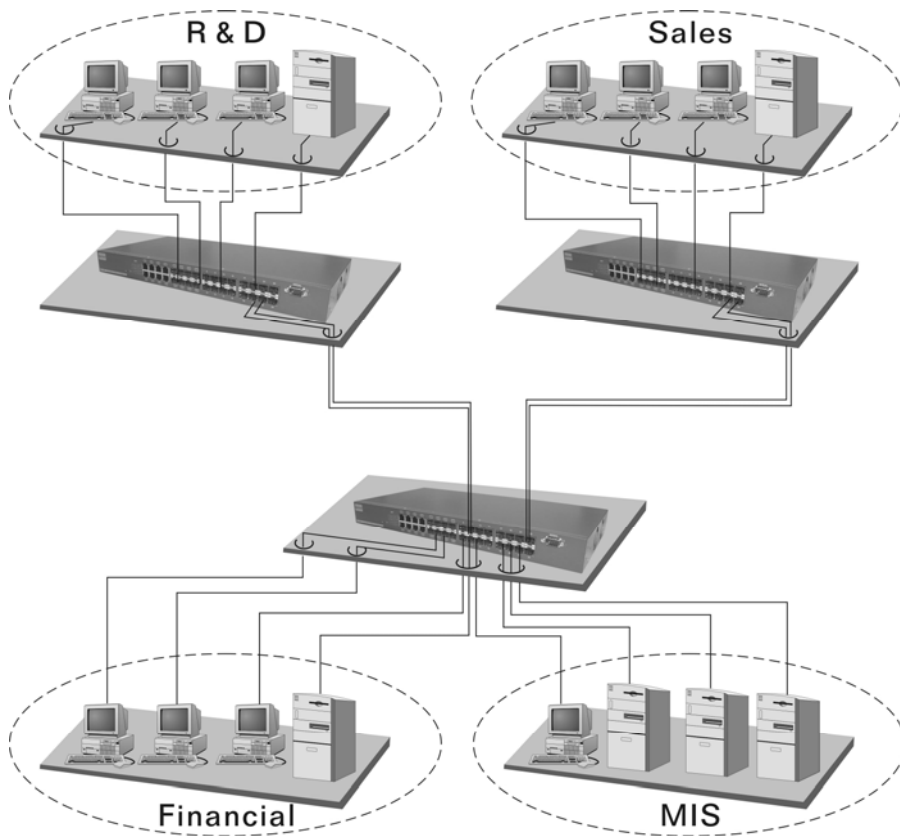

Fig. 2-15 Office Network Connection

3. Operation of Web-based Management

This chapter instructs you how to configure and manage the GEFXL2P-SW24 through the web user interface it supports, to access and manage the 16-Port Gigabit SFP and 8-Port Gigabit TP/SFP Fiber management Ethernet switch. With this facility, you can easily access and monitor through any one port of the switch all the status of the switch, including MIBs status, each port activity, Spanning tree status, port aggregation status, multicast traffic, VLAN and priority status, even illegal access record and so on.

The default values of the managed switch are listed in the table below:

IP Address	192.168.1.1
Subnet Mask	255.255.255.0
Default Gateway	192.168.1.254
Username	admin
Password	admin

Table 3-1

After the managed switch has been finished configuration in the CLI via the switch's serial interface, you can browse it. For instance, type <http://192.168.1.1> in the address row in a browser, it will show the following screen (see Fig.3-1) and ask you inputting username and password in order to login and access authentication. The default username and password are both "admin". For the first time to use, please enter the default username and password, then click the **<Login>** button. The login process now is completed.

Just click the link of "Forget Password" in WebUI (See Fig. 3-1) or input "Ctrl+Z" in CLI's login screen (See Fig. 4-1~4-2) in case the user forgets the manager's password. Then, the system will display a serial No. for the user. Write down this serial No. and contact your vendor, the vendor will give you a temporary password. Use this new password as ID and Password, and it will allow the user to login the system with manager authority temporarily. Due to the limit of this new password, the user only can login the system one time, therefore, please modify your password immediately after you login in the system successfully.

In this login menu, you have to input the complete username and password respectively, the switch will not give you a shortcut to username automatically. This looks inconvenient, but safer.

In the switch, it supports a simple user management function allowing only one administrator to configure the system at the same time. If there are two or more users using administrator's identity, the switch will allow the only one who logs in first to configure the system. The rest of users, even with administrator's identity, can only monitor the system. For those who have no administrator's identity, can only monitor the system. There are only a maximum of three users able to login simultaneously in the switch.

To optimize the display effect, we recommend you use Microsoft IE 6.0 above, Netscape V7.1 above or FireFox V1.00 above and have the resolution 1024x768. The switch supported neutral web browser interface.

In Fig. 3-2, for example, left section is the whole function tree with web user interface and we will travel it through this chapter.

Please Input Username & Password

Username:

Password:

[Forget Password?](#)

Fig. 3-1

3-1. Web Management Home Overview

After you login, the switch shows you the system information as Fig. 3-2. This page is default and tells you the basic information of the system, including “Model Name”, “System Description”, “Location”, “Contact”, “Device Name”, “System Up Time”, “Current Time”, “BIOS Version”, “Firmware Version”, “Hardware-Mechanical Version”, “Serial Number”, “Host IP Address”, “Host Mac Address”, “Device Port”, “RAM Size” and “Flash Size”. With this information, you will know the software version used, MAC address, serial number, how many ports good and so on. This is helpful while malfunctioning.

The screenshot shows the web management interface of a switch. At the top left, there is an 'Auto Logout' dropdown menu set to 'OFF'. Below it is a navigation tree with various system functions. The main content area displays 'System Information' for a GEFXL2P-SW24 switch. The information includes model name, system description, location, contact, device name, system up time, current time, BIOS and firmware versions, hardware-mechanical version, serial number, host IP and MAC addresses, device port details, RAM size, flash size, and CPU load. An 'Apply' button is located at the bottom of the information table.

System Information	
Model Name	GEFXL2P-SW24
System Description	16-Port SFP + 8-Port Combo Port GbE L2 Plus Managed Switch
Location	<input type="text"/>
Contact	<input type="text"/>
Device Name	GEFXL2P-SW24
System Up Time	0 Days 0 Hours 0 Mins 28 Secs
Current Time	Mon Aug 03 13:59:59 2009
BIOS Version	V1.04
Firmware Version	v1.43
Hardware-Mechanical Version	V1.01-V1.01
Serial Number	032201000015
Host IP Address	192.168.2.50
Host MAC Address	00-40-c7-5e-00-0e
Device Port	UART * 1, Dual-Media Port(RJ45-SFP) * 8, SFP * 16
RAM Size	512 M
Flash Size	128 M
CPU Load	6%

Fig. 3-2

- **The Information of Page Layout**

- On the top side, it shows the front panel of the switch. In the front panel, the linked ports will display green; as to the ports, which are link off, they will be dark. For the optional modules, the slot will show only a cover plate if no module exists and will show a module if a module is present. The image of module depends on the one you inserted. The same, if disconnected, the port will show just dark, if linked, green. **(See Fig. 3-3)**



The screenshot shows a web browser window titled "http://192.168.2.25/iconportdetail.htm - Windows Internet Explorer". The main content area displays "Port 1 Detail Information" with a table of port statistics. Below the table is a "Close" button. The browser's status bar at the bottom shows "Done", "Internet", and "100%" zoom level.

Link	Up
State	Enabled
Auto Negotiation	Enabled
Speed/Duplex	1G/Full
Flow Control	rx on, tx on
Ingress All State	Disabled
Ingress All Rate	500 Kbps
Egress All State	Disabled
Egress All Rate	500 Kbps
Tx Byte	83752
Rx Byte	3714
Tx Packet	8496493
Rx Packet	1341358
Tx Collision	0
Rx Error Packet	0
Description	

Fig. 3-3 port detail information

In **Fig. 3-3**, it shows the basic information of the clicked port. With this, you'll see the information about the port status, traffic status and bandwidth rating for egress and ingress respectively.

- On the left-top corner, there is a pull-down list for Auto Logout. For the sake of security, we provide auto-logout function to protect you from illegal user as you are leaving. If you do not choose any selection in Auto Logout list, it means you turn on the Auto Logout function and the system will be logged out automatically when no action on the device 3 minutes later. If OFF is chosen, the screen will keep as it is. Default is ON.
- On the left side, the main menu tree for web is listed in the page. They are hierarchical menu. Open the function folder, a sub-menu will be shown. The functions of each folder are described in its corresponded section respectively. When clicking it, the function is performed. The following list is the full function tree for web user interface.

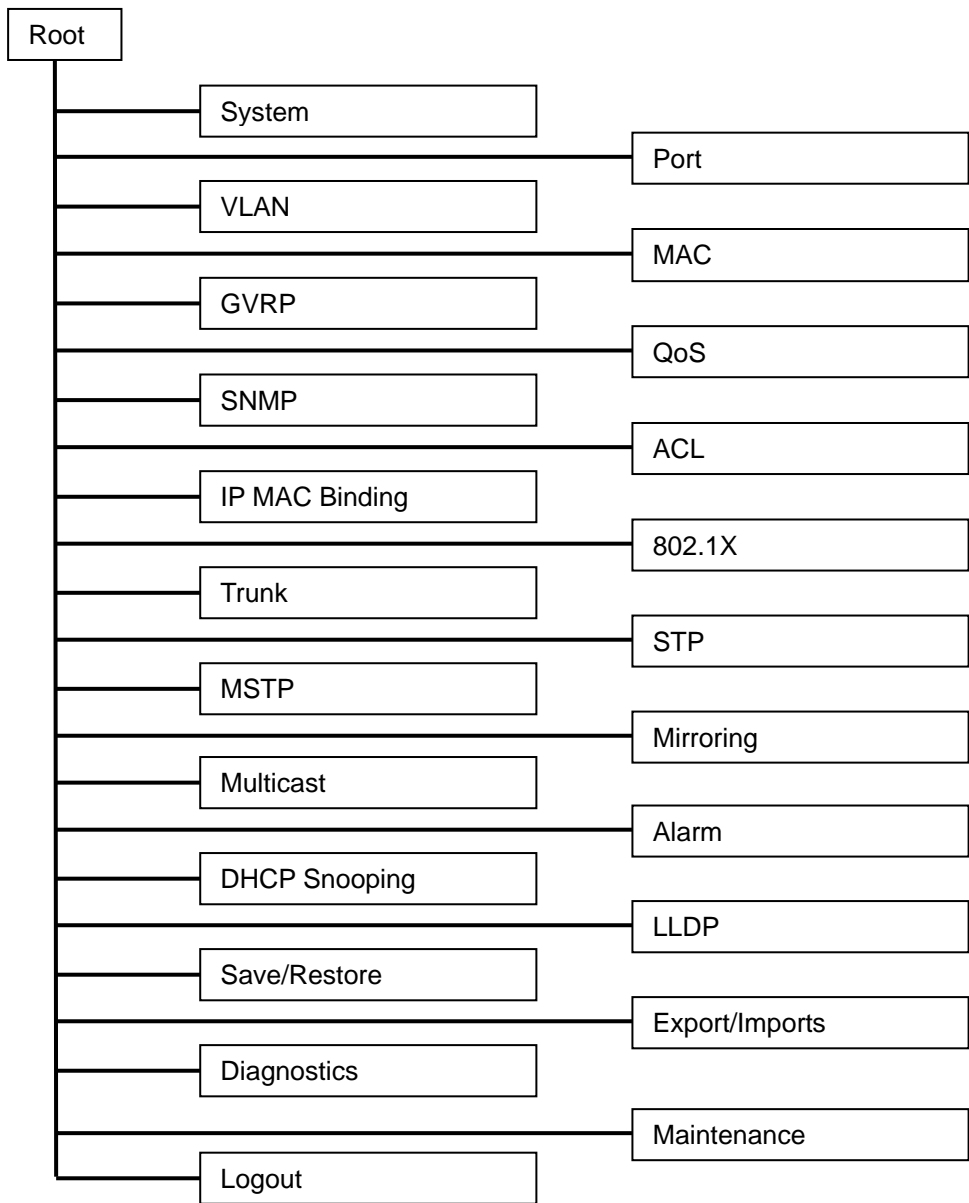

3-1-1. System Information

Function name:

System Information

Function description:

Show the basic system information.

System Information

Model Name	GEFXL2P-SW24
System Description	16-Port SFP + 8-Port Combo Port GbE L2 Plus Managed Switch
Location	<input type="text"/>
Contact	<input type="text"/>
Device Name	GEFXL2P-SW24
System Up Time	0 Days 0 Hours 0 Mins 28 Secs
Current Time	Mon Aug 03 13:59:59 2009
BIOS Version	V1.04
Firmware Version	v1.43
Hardware-Mechanical Version	V1.01-V1.01
Serial Number	032201000015
Host IP Address	192.168.2.50
Host MAC Address	00-40-c7-5e-00-0e
Device Port	UART * 1, Dual-Media Port(RJ45-SFP) * 8, SFP * 16
RAM Size	512 M
Flash Size	128 M
CPU Load	6%

Fig. 3-4

Parameter description:

Model name:

The model name of this device.

System description:

As it is, this tells what this device is. Here, it is “L2 Plus Managed Switch”.

Location:

Basically, it is the location where this switch is put. User-defined.

Contact:

For easily managing and maintaining device, you may write down the contact person and phone here for getting help soon. You can configure this parameter through the device’s user interface or SNMP.

Device name:

The name of the switch. User-defined. Default is GEFXL2P-SW24.

System up time:

The time accumulated since this switch is powered up. Its format is day, hour, minute, second.

Current time:

Show the system time of the switch. Its format: day of week, month, day, hours : minutes : seconds, year. For instance, Mon, March. 03, 14:54:07, 2008.

BIOS version:

The version of the BIOS in this switch.

Firmware version:

The firmware version in this switch.

Hardware-Mechanical version:

The version of Hardware and Mechanical. The figure before the hyphen is the version of electronic hardware; the one after the hyphen is the version of mechanical.

Serial number:

The serial number is assigned by the manufacturer.

Host IP address:

The IP address of the switch.

Host MAC address:

It is the Ethernet MAC address of the management agent in this switch.

Device Port:

Show all types and numbers of the port in the switch.

RAM size:

The size of the DRAM in this switch.

Flash size:

The size of the flash memory in this switch.

CPU Load:

To display the CPU loading percent on this switch.

3-1-2. Account Configuration

In this function, only administrator can create, modify or delete the username and password. Administrator can modify other guest identities' password without confirming the password but it is necessary to modify the administrator-equivalent identity. Guest-equivalent identity can modify his password only. Please note that you must confirm administrator/guest identity in the field of Authorization in advance before configuring the username and password. Only one administrator is allowed to exist and unable to be deleted. In addition, up to 4 guest accounts can be created.

The default setting for user account is:

Username: admin

Password : admin

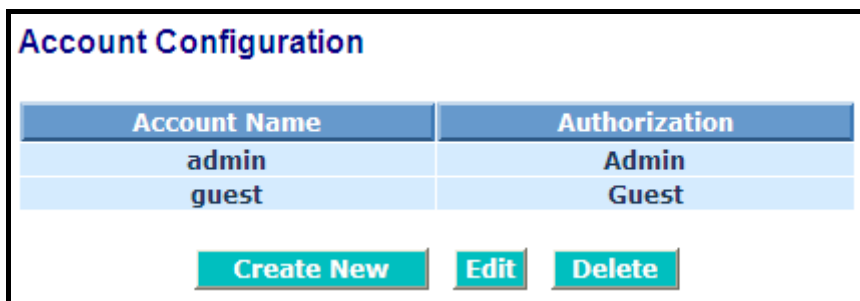

Account Name	Authorization
admin	Admin
guest	Guest

[Create New](#) [Edit](#) [Delete](#)

Fig. 3-5

3-1-3. Time Configuration

The switch provides manual and automatic ways to set the system time via NTP. Manual setting is simple and you just input "Year", "Month", "Day", "Hour", "Minute" and "Second" within the valid value range indicated in each item. If you input an invalid value, for example, 61 in minute, the switch will clamp the figure to 59.

NTP is a well-known protocol used to synchronize the clock of the switch system time over a network. NTP, an internet draft standard formalized in RFC 1305, has been adopted on the system is version 3 protocol. The switch provides four built-in NTP server IP addresses resided in the Internet and an user-defined NTP server IP address. The time zone is Greenwich-centered which uses the expression form of GMT+/- xx hours.

Function name:

Time

Function description:

Set the system time by manual input or set it by syncing from Time servers. The function also supports daylight saving for different area's time adjustment.

System Time Setting

Current Time		Mon Mar 03 15:30:44 2008					
<input checked="" type="radio"/> Manual	Year	<input type="text" value="2008"/>	(2000~2036)	Month	<input type="text" value="3"/>	(1~12)	
	Day	<input type="text" value="3"/>	(1~31)	Hour	<input type="text" value="15"/>	(0~23)	
	Minute	<input type="text" value="30"/>	(0~59)	Second	<input type="text" value="44"/>	(0~59)	
<input type="radio"/> NTP	<input type="radio"/> 209.81.9.7(USA)					Time Zone <input type="text" value="GMT"/>	
	<input type="radio"/> 137.189.8.174(HK)						
	<input type="radio"/> 133.100.9.2(JP)						
	<input type="radio"/> 131.188.3.222(Germany)						
	<input type="radio"/> <input type="text" value="209.81.9.7"/>						
Daylight Saving		<input type="text" value="0"/>					
Daylight Saving Start		Mth	<input type="text" value="1"/>	Day	<input type="text" value="1"/>	Hour	<input type="text" value="0"/>
Daylight Saving End		Mth	<input type="text" value="1"/>	Day	<input type="text" value="1"/>	Hour	<input type="text" value="0"/>
<input type="button" value="Apply"/>							

Fig. 3-6

Parameter description:

Current Time:

Show the current time of the system.

Manual:

This is the function to adjust the time manually. Filling the valid figures in the fields of Year, Month, Day, Hour, Minute and Second respectively and press **<Apply>** button, time is adjusted. The valid figures for the parameter Year, Month, Day, Hour, Minute and Second are ≥ 2000 , 1-12, 1-31, 0-23, 0-59 and 0-59 respectively. Input the wrong figure and press **<Apply>** button, the device will reject the time adjustment request. There is no time zone setting in Manual mode.

Default: Year = 2000, Month = 1, Day = 1
 Hour = 0, Minute = 0, Second = 0

NTP:

NTP is Network Time Protocol and is used to sync the network time based Greenwich Mean Time (GMT). If use the NTP mode and select a built-in NTP time server or manually specify a user-defined NTP server as well as Time Zone, the switch will sync the time in a short after pressing **<Apply>** button. Though it synchronizes the time automatically, NTP does not update the time periodically without user's processing.

Time Zone is an offset time off GMT. You have to select the time zone first and then perform time sync via NTP because the switch will combine this time zone offset and updated NTP time to come out the local time, otherwise, you will not able to get the correct time. The switch supports configurable time zone from -12 to +13 step 1 hour.

Default Time zone: +8 Hrs.

Daylight Saving:

Daylight saving is adopted in some countries. If set, it will adjust the time lag or in advance in unit of hours, according to the starting date and the ending date. For example, if you set the day light saving to be 1 hour. When the time passes over the starting time, the system time will be increased one hour after one minute at the time since it passed over. And when the time passes over the ending time, the system time will be decreased one hour after one minute at the time since it passed over.

The switch supports valid configurable day light saving time is $-5 \sim +5$ step one hour. The zero for this parameter means it need not have to adjust current time, equivalent to in-act daylight saving. You don't have to set the starting/ending date as well. If you set daylight saving to be non-zero, you have to set the starting/ending date as well; otherwise, the daylight saving function will not be activated.

Default for Daylight Saving: 0.

The following parameters are configurable for the function Daylight Saving and described in detail.

Day Light Saving Start :

This is used to set when to start performing the day light saving time.

Mth:

Range is 1 ~ 12.

Default: 1

Day:

Range is 1 ~ 31.

Default: 1

Hour:

Range is 0 ~ 23.

Default: 0

Day Light Saving End :

This is used to set when to stop performing the daylight saving time.

Mth:

Range is 1 ~ 12.

Default: 1

Day:

Range is 1 ~ 31.

Default: 1

Hour:

Range is 0 ~ 23.

Default: 0

3-1-4. IP Configuration

IP configuration is one of the most important configurations in the switch. Without the proper setting, network manager will not be able to manage or view the device. The switch supports both manual IP address setting and automatic IP address setting via DHCP server. When IP address is changed, you must reboot the switch to have the setting taken effect and use the new IP to browse for web management and CLI management.

Function name:

IP Configuration

Function description:

Set IP address, subnet mask, default gateway and DNS for the switch.

IP Configuration

DHCP Setting	<input type="checkbox"/> Enable
IP Address	192.168.2.25
Current IP Address	192.168.2.25
Subnet Mask	255.255.255.0
Default Gateway	192.168.2.254
Current Gateway	192.168.2.254
DNS Server	Manual <input type="text" value="0.0.0.0"/>

Apply

Fig. 3-7 IP Address Configuration

Parameter description:

DHCP Setting:

DHCP is the abbreviation of Dynamic Host Configuration Protocol. Here DHCP means a switch to turn ON or OFF the function.

The switch supports DHCP client used to get an IP address automatically if you set this function "Enable". When enabled, the switch will issue the request to the DHCP server resided in the network to get an IP address. If DHCP server is down or does not exist, the switch will issue the request and show IP address is under requesting, until the DHCP server is up. Before getting an IP address from DHCP server, the device will not continue booting procedures. If set this field "Disable", you'll have to input IP address manually. For more details about IP address and DHCP, please see the Section 2-1-5 "IP Address Assignment" in this manual.

Default: Disable

IP address:

Users can configure the IP settings and fill in new values if users set the DHCP function “Disable”. Then, click **<Apply>** button to update.

When DHCP is disabled, Default: 192.168.1.1

If DHCP is enabled, this field is filled by DHCP server and will not allow user manually set it any more.

Subnet mask:

Subnet mask is made for the purpose to get more network address because any IP device in a network must own its IP address, composed of Network address and Host address, otherwise can't communicate with other devices each other. But unfortunately, the network classes A, B, and C are all too large to fit for almost all networks, hence, subnet mask is introduced to solve this problem. Subnet mask uses some bits from host address and makes an IP address looked Network address, Subnet mask number and host address. It is shown in the following figure. This reduces the total IP number of a network able to support, by the amount of 2 power of the bit number of subnet number ($2^{(\text{bit number of subnet number})}$).

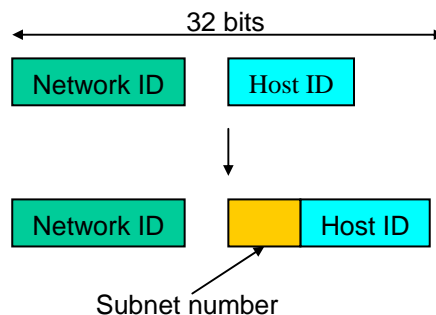

Subnet mask is used to set the subnet mask value, which should be the same value as that of the other devices resided in the same network it attaches.

For more information, please also see the Section 2-1-5 “IP Address Assignment” in this manual.

Default: 255.255.255.0

Default gateway:

Set an IP address for a gateway to handle those packets that do not meet the routing rules predefined in the device. If a packet does not meet the criteria for other pre-defined path, it must be forwarded to a default router on a default path. This means any packet with undefined IP address in the routing table will be sent to this device unconditionally.

Default: 192.168.1.254

DNS:

It is Domain Name Server used to serve the translation between IP address and name address.

The switch supports DNS client function to re-route the mnemonic name address to DNS server to get its associated IP address for accessing Internet. User can specify a DNS IP address for the switch. With this, the switch can translate a mnemonic name address into an IP address.

There are two ways to specify the IP address of DNS. One is fixed mode, which manually specifies its IP address, the other is dynamic mode, which is assigned by DHCP server while DHCP is enabled. DNS can help you easily remember the mnemonic address name with the meaningful words in it. Default is no assignment of DNS address.

Default: 0.0.0.0

3-1-5. Loop Detection

The loop detection is used to detect the presence of traffic. When switch receives packet's(looping detection frame) MAC address the same as oneself from port, show Loop detection happens. The port will be locked when it received the looping detection frames. If you want to resume the locked port, please find out the looping path and take off the looping path, then select the resume the locked port and click on "Resume" to turn on the locked ports.

Function name:

Loop Detection

Function description:

Display whether switch open Loop detection.

Port No																							
1	2	3	4	5	6	7	8	9	10	11	12	13	14	15	16	17	18	19	20	21	22	23	24
<input type="checkbox"/>	<input type="checkbox"/>	<input type="checkbox"/>	<input type="checkbox"/>	<input type="checkbox"/>	<input type="checkbox"/>	<input type="checkbox"/>	<input type="checkbox"/>	<input type="checkbox"/>	<input type="checkbox"/>	<input type="checkbox"/>	<input type="checkbox"/>	<input type="checkbox"/>	<input type="checkbox"/>	<input type="checkbox"/>	<input type="checkbox"/>	<input type="checkbox"/>	<input type="checkbox"/>	<input type="checkbox"/>	<input type="checkbox"/>	<input type="checkbox"/>	<input type="checkbox"/>	<input type="checkbox"/>	<input type="checkbox"/>

Enable

Port No																							
1	2	3	4	5	6	7	8	9	10	11	12	13	14	15	16	17	18	19	20	21	22	23	24
<input type="checkbox"/>	<input type="checkbox"/>	<input type="checkbox"/>	<input type="checkbox"/>	<input type="checkbox"/>	<input type="checkbox"/>	<input type="checkbox"/>	<input type="checkbox"/>	<input type="checkbox"/>	<input type="checkbox"/>	<input type="checkbox"/>	<input type="checkbox"/>	<input type="checkbox"/>	<input type="checkbox"/>	<input type="checkbox"/>	<input type="checkbox"/>	<input type="checkbox"/>	<input type="checkbox"/>	<input type="checkbox"/>	<input type="checkbox"/>	<input type="checkbox"/>	<input type="checkbox"/>	<input type="checkbox"/>	<input type="checkbox"/>

Resume

Fig. 3-8

Parameter description:

Port No:

Display the port number. The number is 1 – 24.

Detection Port - Enable:

When Port No is chosen, and enable port' s Loop detection, the port can detect loop happens. When Port-No is chosen, enable port' s Loop detection, and the port detects loop happen, port will be Locked. If Loop did not happen, port maintains Unlocked.

Locked Port - Resume:

When Port No is chosen, enable port' s Loop detection, and the port detects loop happen, the port will be Locked. When choosing Resume, port locked will be opened and turned into unlocked. If not choosing Resume, Port maintains locked.

3-1-6. Management Policy

Through the management security configuration, the manager can do the strict setup to control the switch and limit the user to access this switch.

The following rules are offered for the manager to manage the switch:

Rule 1) : When no lists exists, then it will accept all connections.

Accept

Rule 2) : When only “accept lists” exist, then it will deny all connections, excluding the connection inside of the accepting range.

Accept Deny **Accept** Deny **Accept**

Rule 3) : When only “deny lists” exist, then it will accept all connections, excluding the connection inside of the denying range.

Deny Accept **Deny** Accept **Deny**

Rule 4) : When both “accept and deny” lists exist, then it will deny all connections, excluding the connection inside of the accepting range.

Accept Deny **Deny** Deny **Accept**

Rule 5) : When both “accept and deny” lists exist, then it will deny all connections, excluding the connection inside of the accepting range and NOT inside of the denying range at the same time.

Accept	
	Deny

Accept

Deny| Acc | Deny | Acc | Deny

Function name:

Management Security Configuration

Function description:

The switch offers Management Security Configuration function. With this function, the manager can easily control the mode that the user connects to the switch. According to the mode, users can be classified into two types: Those who are able to connect to the switch (Accept) and those who are unable to connect to the switch (Deny). Some restrictions also can be placed on the mode that the user connect to the switch, for example, we can decide that which VLAN VID is able to be accepted or denied by the switch, the IP range of the user could be accepted or denied by the switch, the port that the user is allowed or not allowed to connect with the switch, or the way of controlling and connecting to the switch via Http, Telnet or SNMP.

No	Name	IP Range	Access Type	Action
<input type="checkbox"/> 1		Any	Port Members Any	Allow

Fig. 3-9

Create Management Policy

Name	IP Range	Access Type
<input type="text"/>	<input checked="" type="radio"/> Any <input type="radio"/> Custom	<input type="radio"/> Any <input checked="" type="radio"/> Custom <input type="checkbox"/> HTTP <input type="checkbox"/> TELNET <input type="checkbox"/> SNMP

Incoming Port	Action
<input checked="" type="radio"/> Any <input type="radio"/> Custom	<input type="radio"/> Deny <input checked="" type="radio"/> Accept
1. <input type="checkbox"/> 2. <input type="checkbox"/> 3. <input type="checkbox"/> 4. <input type="checkbox"/> 5. <input type="checkbox"/> 6. <input type="checkbox"/> 7. <input type="checkbox"/> 8. <input type="checkbox"/> 9. <input type="checkbox"/> 10. <input type="checkbox"/> 11. <input type="checkbox"/> 12. <input type="checkbox"/> 13. <input type="checkbox"/> 14. <input type="checkbox"/> 15. <input type="checkbox"/> 16. <input type="checkbox"/> 17. <input type="checkbox"/> 18. <input type="checkbox"/> 19. <input type="checkbox"/> 20. <input type="checkbox"/> 21. <input type="checkbox"/> 22. <input type="checkbox"/> 23. <input type="checkbox"/> 24. <input type="checkbox"/>	

Fig. 3-10

Add:

A new entry of Management Security Configuration can be created after the parameters as mentioned above had been setup and then press **<Add>** button. Of course, the existed entry also can be modified by pressing this button.

Delete:

Remove the existed entry of Management Security Configuration from the management security table.

Name:

A name is composed of any letter (A-Z, a-z) and digit (0-9) with maximal 8 characters.

VID:

The switch supports two kinds of options for managed valid VLAN VID, including "Any" and "Custom". Default is "Any". When you choose "Custom", you can fill in VID number. The valid VID range is 1~4094.

IP Range:

The switch supports two kinds of options for managed valid IP Range, including "Any" and "Custom". Default is "Any". In case that "Custom" had been chosen, you can assigned effective IP range. The valid range is 0.0.0.0~255.255.255.255.

Incoming Port:

The switch supports two kinds of options for managed valid Port Range, including "Any" and "Custom". Default is "Any". You can select the ports that you would like them to be worked and restricted in the management security configuration if "Custom" had been chosen.

Access Type:

The switch supports two kinds of options for managed valid Access Type, including "Any" and "Custom". Default is "Any". "Http", "Telnet" and "SNMP" are three ways for the access and managing the switch in case that "Custom" had been chosen.

Action:

The switch supports two kinds of options for managed valid Action Type, including "Deny" and "Accept". Default is "Deny". When you choose "Deny" action, you will be restricted and refused to manage the switch due to the "Access Type" you choose. However, while you select "Accept" action, you will have the authority to manage the switch.

3-1-7. System log

The System Log provides information about system logs, including information when the device was booted, how the ports are operating, when users log in, when sessions timed out, as well as other system information.

Function name:

System log

Function description:

The Trap Log Data is displaying the log items including all SNMP Private Trap events, SNMP Public traps and user logs occurred in the system. In the report table, No., Time and Events are three fields contained in each trap record.

System Log

No	Time	Desc
1	Mon Mar 09 11:45:58 2009	Login [admin]
2	Mon Mar 09 08:44:15 2009	Login [admin]
3	Mon Mar 09 08:37:33 2009	Cold Start
4	Mon Mar 09 08:37:33 2009	Link Up [Port:1]

Clear

Fig. 3-11

Parameter description:

No:

Display the order number that the trap happened.

Time:

Display the time that the trap happened.

Desc:

Displays a description event recorded in the System Log.

Clear:

Clear log data.

3-1-8. Virtual Stack

Function name:

Virtual Stack

Function description:

Virtual Stack Management(VSM) is the group management function. Through the proper configuration of this function, switches in the same LAN will be grouped automatically. And among these switch, one switch will be a master machine, and the others in this group will become the slave devices.

VSM offers a simple centralized management function. It is not necessary to remember the address of all devices, manager is capable of managing the network with knowing the address of the Master machine. Instead of SNMP or Telnet UI, VSM is only available in Web UI. While one switch become the Master, two rows of buttons for group device will appear on the top of its Web UI. By pressing these buttons, user will be allowed to connect the Web UI of the devices of the group in the same window without the login of these device.

The most top-left button is only for Master device(See Fig.3-9). The background color of the button you press will be changed to represent that the device is under your management.

Note: It will remove the grouping temporarily in case that you login the switch via the console.

The device of the group will be shown as station address (the last number of IP Address) + device name on the button (e.g. 196_GS-2224L), otherwise it will show " ---- " if no corresponding device exists.

Once the devices join the group successfully, then they are merely able to be managed via Master device, and user will fail to manage them via telnet/console/web individually.

Up to 16 devices can be grouped for VSM, however, only one Master is allowed to exist in each group. For Master redundancy, user may configure more than two devices as Master device, however, the Master device with the smaller MAC value will be the Master one. All of these 16 devices can become Master device and back up with each other .

Virtual Stack Configuration

State	Enable
Role	Master
Group ID	default

Apply

Note: You should be logout every time when you change the state of Virtual Stack.

25_GEFXL2P	----	----	----	----	----	----	----
----	----	----	----	----	----	----	----

Fig. 3-10-1

Parameter description:

State:

It is used for the activation or de-activation of VSM. Default is Enable.

Role:

The role that the switch would like to play in virtual stack. Two types of roles, including master and slave are offered for option. Default is Master.

Group ID:

It is the group identifier (GID) which signs for VSM. Valid letters are A-Z, a-z, 0-9, “ - “ and “ _ ” characters. The maximal length is 15 characters.

3-2. Port Configuration

Four functions, including Port Status, Port Configuration, Simple Counter and Detail Counter are contained in this function folder for port monitor and management. Each of them will be described in detail orderly in the following sections.

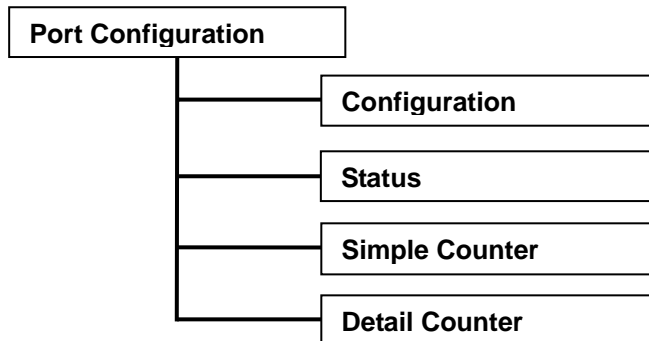

3-2-1. Port Configuration

Port Configuration is applied to change the setting of each port. In this configuration function, you can set/reset the following functions. All of them are described in detail below.

Function name:

Port Configuration

Function description:

It is used to set each port's operation mode. The switch supports 3 parameters for each port. They are state, mode and flow control.

Port Configuration

Port	Media	Speed	Flow Control	Maximum Frame	Excessive Collision Mode	Description
1	TP	Auto	<input checked="" type="checkbox"/>	9600	Discard	
	SFP	Auto				
2	TP	Auto	<input checked="" type="checkbox"/>	9600	Discard	
	SFP	Auto				
3	TP	Auto	<input checked="" type="checkbox"/>	9600	Discard	
	SFP	Auto				
4	TP	Auto	<input checked="" type="checkbox"/>	9600	Discard	
	SFP	Auto				
5	TP	Auto	<input checked="" type="checkbox"/>	9600	Discard	
	SFP	Auto				
6	TP	Auto	<input checked="" type="checkbox"/>	9600	Discard	
	SFP	Auto				
7	TP	Auto	<input checked="" type="checkbox"/>	9600	Discard	
	SFP	Auto				
8	TP	Auto	<input checked="" type="checkbox"/>	9600	Discard	
	SFP	Auto				
9	SFP	Auto	<input checked="" type="checkbox"/>	9600		
10	SFP	Auto	<input checked="" type="checkbox"/>	9600		
11	SFP	Auto	<input checked="" type="checkbox"/>	9600		
12	SFP	Auto	<input checked="" type="checkbox"/>	9600		
13	SFP	Auto	<input checked="" type="checkbox"/>	9600		
14	SFP	Auto	<input checked="" type="checkbox"/>	9600		
15	SFP	Auto	<input checked="" type="checkbox"/>	9600		
16	SFP	Auto	<input checked="" type="checkbox"/>	9600		
17	SFP	Auto	<input checked="" type="checkbox"/>	9600		
18	SFP	Auto	<input checked="" type="checkbox"/>	9600		
19	SFP	Auto	<input checked="" type="checkbox"/>	9600		
20	SFP	Auto	<input checked="" type="checkbox"/>	9600		
21	SFP	Auto	<input checked="" type="checkbox"/>	9600		
22	SFP	Auto	<input checked="" type="checkbox"/>	9600		
23	SFP	Auto	<input checked="" type="checkbox"/>	9600		
24	SFP	Auto	<input checked="" type="checkbox"/>	9600		

Apply

Fig. 3-12

Parameter description:

Port:

To display the port index

Media:

To display the port media type with UTP or SFP

Speed:

Set the speed and duplex of the port. In speed, if the media is 1Gbps fiber, it is always 1000Mbps and the duplex is full only. If the media is TP, the Speed/Duplex is comprised of the combination of speed mode, 10/100/1000Mbps, and duplex mode, full duplex and half duplex. The following table summarized the function the media supports.

Media type	NWay	Speed	Duplex
1000M TP	ON/OFF	10/100/1000M	Full for all, Half for 10/100
1000M Fiber	ON/OFF	1000M	Full

In Auto-negotiation mode, no default value. In Forced mode, default value depends on your setting.

Flow Control:

There are two modes to choose in flow control, including Enable and Disable. If flow control is set Enable, both parties can send PAUSE frame to the transmitting device(s) if the receiving port is too busy to handle. When it is set Disable, there will be no flow control in the port. It drops the packet if too much to handle.

Maximum Frame:

This module offer 1518~9600 (Bytes) length to make the long packet.

Excessive Collision Mode:

There are two modes to choose when excessive collision happen in half-duplex condition as below:

Discard: The “**Discard**” mode determines whether the MAC drop frames after an excessive collision has occurred. If set, a frame is dropped after excessive collisions. This is IEEE Std 802.3 half-duplex flow control operation.

Restart: The “**Restart**” mode determines whether the MAC retransmits frames after an excessive collision has occurred. If set, a frame is not dropped after excessive collisions, but the backoff sequence is restarted. This is a violation of IEEE Std 802.3, but is useful in non-dropping half-duplex flow control operation.

Description:

Description of device ports can not include “ # % & ' + \.

3-2-2.Port Status

The function Port Status gathers the information of all ports' current status and reports it by the order of port number, media, link status, port state, Auto-Negotiation status, speed/duplex, Rx Pause and Tx Pause. An extra media type information for the module ports 1 and 8 is also offered (See Fig. 3-14).

Port Status

Port	Link	Speed	Flow Control		Description	Media
			Rx	Tx		
1	up	1Gfdx	V	V		TP
2	down	down	X	X		TP
3	down	down	X	X		TP
4	down	down	X	X		TP
5	down	down	X	X		TP
6	down	down	X	X		TP
7	down	down	X	X		TP
8	down	down	X	X		TP
9	down	down	X	X		SFP
10	down	down	X	X		SFP
11	down	down	X	X		SFP
12	down	down	X	X		SFP
13	down	down	X	X		SFP
14	down	down	X	X		SFP
15	down	down	X	X		SFP
16	down	down	X	X		SFP
17	down	down	X	X		SFP
18	down	down	X	X		SFP
19	down	down	X	X		SFP
20	down	down	X	X		SFP
21	down	down	X	X		SFP
22	down	down	X	X		SFP
23	down	down	X	X		SFP
24	down	down	X	X		SFP

Fig. 3-13

Function name:

Port Status

Function Description:

Report the latest updated status of all ports in this switch. When any one of the ports in the switch changes its parameter displayed in the page, it will be automatically refreshed the port current status about every 5 seconds.

Parameter Description:

Port:

Display the port number. The number is 1 – 24. Both port 1-8 are optional modules.

Link:

Show that if the link on the port is active or not. If the link is connected to a working-well device, the Link will show the link “Up”; otherwise, it will show “Down”. This is determined by the hardware on both devices of the connection.

No default value.

Speed / Duplex Mode:

Display the speed and duplex of all port. There are three speeds 10Mbps, 100Mbps and 1000Mbps supported for TP media, and the duplex supported is half duplex and full duplex. If the media is 1Gbps fiber, it is 1000Mbps supported only. The status of speed/duplex mode is determined by 1) the negotiation of both local port and link partner in “Auto Speed” mode or 2) user setting in “Force” mode. The local port has to be preset its capability.

Default: None, depends on the result of the negotiation.

Flow Control:

Show each port’s flow control status.

There are two types of flow control in Ethernet, Backpressure for half-duplex operation and Pause flow control (IEEE802.3x) for full-duplex operation. The switch supports both of them.

Default: None, depends on the result of the negotiation.

Description:

network managers provide a description of device ports.

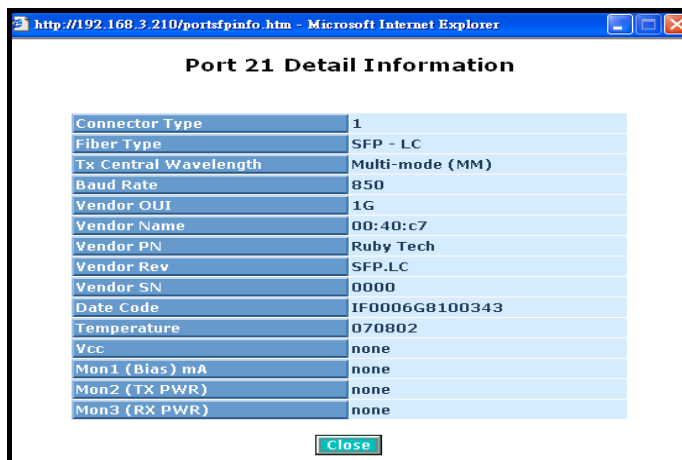

The screenshot shows a web browser window with the address bar containing 'http://192.168.3.210/portsinfo.htm - Microsoft Internet Explorer'. The main content area displays a table titled 'Port 21 Detail Information' with the following data:

Parameter	Value
Connector Type	1
Fiber Type	SFP - LC
Tx Central Wavelength	Multi-mode (MM)
Baud Rate	850
Vendor OUI	1G
Vendor Name	00:40:c7
Vendor PN	Ruby Tech
Vendor Rev	SFP.LC
Vendor SN	0000
Date Code	IF0006G8100343
Temperature	070802
Vcc	none
Mon1 (Bias) mA	none
Mon2 (TX PWR)	none
Mon3 (RX PWR)	none

At the bottom of the table, there is a 'Close' button.

Fig. 3-14

Parameter description of Port 1 ~ Port 24:

Connector Type:

Display the connector type, for instance, UTP, SC, ST, LC and so on.

Fiber Type:

Display the fiber mode, for instance, Multi-Mode, Single-Mode.

Tx Central Wavelength:

Display the fiber optical transmitting central wavelength, for instance, 850nm, 1310nm, 1550nm and so on.

Baud Rate:

Display the maximum baud rate of the fiber module supported, for instance, 10M, 100M, 1G and so on.

Vendor OUI:

Display the Manufacturer's OUI code which is assigned by IEEE.

Vendor Name:

Display the company name of the module manufacturer.

Vendor P/N:

Display the product name of the naming by module manufacturer.

Vendor Rev (Revision):

Display the module revision.

Vendor SN (Serial Number):

Show the serial number assigned by the manufacturer.

Date Code:

Show the date this SFP module was made.

Temperature:

Show the current temperature of SFP module.

Vcc:

Show the working DC voltage of SFP module.

Mon1(Bias) mA:

Show the Bias current of SFP module.

Mon2(TX PWR):

Show the transmit power of SFP module.

Mon3(RX PWR):

Show the receiver power of SFP module.

3-2-3. Simple Counter

The function of Simple Counter collects any information and provides the counting about the traffic of the port, no matter the packet is good or bad.

In the **Fig. 3-15**, the window can show all ports' counter information at the same time. Each data field has 20-digit long. If the counting is overflow, the counter will be reset and restart counting. The data is updated every time interval defined by the user. The Refresh Interval is used to set the update frequency.

Function name:

Simple Counter

Function description:

Display the summary counting of each port's traffic, including Tx Byte, Rx Byte, Tx Packet, Rx Packet, Tx Collision and Rx Error Packet.

Port #	Packets		Bytes		Errors		Drops	
	Receive	Transmit	Receive	Transmit	Receive	Transmit	Receive	Transmit
1	6886	4493	1303805	1240969	0	0	0	0
2	0	0	0	0	0	0	0	0
3	0	0	0	0	0	0	0	0
4	0	0	0	0	0	0	0	0
5	0	0	0	0	0	0	0	0
6	0	0	0	0	0	0	0	0
7	0	0	0	0	0	0	0	0
8	0	0	0	0	0	0	0	0
9	0	0	0	0	0	0	0	0
10	0	0	0	0	0	0	0	0
11	0	143	0	14855	0	0	0	0
12	0	0	0	0	0	0	0	0
13	0	0	0	0	0	0	0	0
14	0	0	0	0	0	0	0	0
15	0	0	0	0	0	0	0	0
16	0	0	0	0	0	0	0	0
17	0	0	0	0	0	0	0	0
18	0	0	0	0	0	0	0	0
19	0	0	0	0	0	0	0	0
20	0	0	0	0	0	0	0	0
21	0	0	0	0	0	0	0	0
22	0	0	0	0	0	0	0	0
23	0	0	0	0	0	0	0	0
24	0	0	0	0	0	0	0	0

Fig. 3-15

Parameters description:

Packet:

Transmit:

The counting number of the packet transmitted.

Receive:

The counting number of the packet received.

Bytes:**Transmit:**

Total transmitted bytes.

Receive:

Total received bytes.

Error:**Transmit:**

Number of bad packets transmitted.

Receive:

Number of bad packets received.

Drops:**Transmit:**

Number of packets transmitted drop.

Receive:

Number of packets received drop.

Auto-refresh:

The simple counts will be refreshed automatically on the UI screen.

Refresh:

The simple counts will be refreshed manually when user use mouse to click on "**Refresh**" button.

Clear:

The simple counts will be reset to zero when user use mouse to click on "**Clear**" button.

3-2-4. Detail Counter

The function of Detail Counter collects any information and provides the counting about the traffic of the port, no matter the packet is good or bad.

In the **Fig. 3-16**, the window can show only one port counter information at the same time. To see another port's counter, you have to pull down the list of Select, then you will see the figures displayed about the port you had chosen.

Each data field has 20-digit long. If the counting is overflow, the counter will be reset and restart counting. The data is updated every time interval defined by the user. The valid range is 3 to 10 seconds. The Refresh Interval is used to set the update frequency. Default update time is 3 seconds.

Function name:

Detail Counter

Function description:

Display the detailed counting number of each port's traffic. In the Fig. 3-14, the window can show all counter information of each port at one time.

Receive Total		Transmit Total	
Rx Packets	17438	Tx Packets	5463
Rx Octets	2456877	Tx Octets	1730395
Rx Unicast	9361	Tx Unicast	5461
Rx Multicast	1035	Tx Multicast	0
Rx Broadcast	7042	Tx Broadcast	2
Rx Pause	0	Tx Pause	0
Receive Size Counters		Transmit Size Counters	
Rx 64 Bytes	10611	Tx 64 Bytes	1080
Rx 65-127 Bytes	2066	Tx 65-127 Bytes	17
Rx 128-255 Bytes	1659	Tx 128-255 Bytes	2878
Rx 256-511 Bytes	3065	Tx 256-511 Bytes	216
Rx 512-1023 Bytes	35	Tx 512-1023 Bytes	1152
Rx 1024-1526 Bytes	2	Tx 1024-1526 Bytes	120
Rx 1527- Bytes	0	Tx 1527- Bytes	0
Receive Error Counters		Transmit Error Counters	
Rx Drops	0	Tx Drops	0
Rx CRC/Alignment	0	Tx Late/Exc. Coll.	0
Rx Undersize	0		
Rx Oversize	0		
Rx Fragments	0		
Rx Jabber	0		

Fig. 3-16

Parameter description:

Rx Packets:

The counting number of the packet received.

Rx Octets:

Total received bytes.

Rx High Priority Packets:

Number of Rx packets classified as high priority.

Rx Low Priority Packets:

Number of Rx packets classified as low priority.

Rx Broadcast:

Show the counting number of the received broadcast packet.

Rx Multicast:

Show the counting number of the received multicast packet.

Tx Packets:

The counting number of the packet transmitted.

TX Octets:

Total transmitted bytes.

Tx High Priority Packets:

Number of Tx packets classified as high priority.

Tx Low Priority Packets:

Number of Tx packets classified as low priority.

Tx Broadcast:

Show the counting number of the transmitted broadcast packet.

Tx Multicast:

Show the counting number of the transmitted multicast packet.

Rx 64 Bytes:

Number of 64-byte frames in good and bad packets received.

Rx 65-127 Bytes:

Number of 65 ~ 126-byte frames in good and bad packets received.

Rx 128-255 Bytes:

Number of 127 ~ 255-byte frames in good and bad packets received.

Rx 256-511 Bytes:

Number of 256 ~ 511-byte frames in good and bad packets received.

Rx 512-1023 Bytes:

Number of 512 ~ 1023-byte frames in good and bad packets received.

Rx 1024-Bytes:

Number of 1024-max_length-byte frames in good and bad packets received.

Tx 64 Bytes:

Number of 64-byte frames in good and bad packets transmitted.

Tx 65-127 Bytes:

Number of 65 ~ 126-byte frames in good and bad packets transmitted.

Tx 128-255 Bytes:

Number of 127 ~ 255-byte frames in good and bad packets transmitted.

Tx 256-511 Bytes:

Number of 256 ~ 511-byte frames in good and bad packets transmitted.

Tx 512-1023 Bytes:

Number of 512 ~ 1023-byte frames in good and bad packets transmitted.

Tx 1024-Bytes:

Number of 1024-max_length-byte frames in good and bad packets transmitted.

Rx CRC/Alignment:

Number of Alignment errors and CRC error packets received.

Rx Undersize:

Number of short frames (<64 Bytes) with valid CRC.

Rx Oversize:

Number of long frames(according to max_length register) with valid CRC.

Rx Fragments:

Number of short frames (< 64 bytes) with invalid CRC.

Rx Jabber:

Number of long frames(according to max_length register) with invalid CRC.

Rx Drops:

Frames dropped due to the lack of receiving buffer.

Rx Errors:

Number of the error packet received.

Tx Collisions:

Number of collisions transmitting frames experienced.

Tx Drops:

Number of frames dropped due to excessive collision, late collision, or frame aging.

Tx FIFO Drops:

Number of frames dropped due to the lack of transmitting buffer.

Auto-refresh:

The detail counts will be refreshed automatically on the UI screen.

Refresh:

The detail counts will be refreshed manually when user use mouse to click on “**Refresh**” button.

Clear:

The detail counts will be reset to zero when user use mouse to click on “**Clear**” button.

3-2-5. Power Saving

The function of Power Saving and provides the Power saving for reduce the power consumption with "ActiPHY Power Management" and "PerfectReach Power Management" two technique.It could efficient saving the switch Power when the client idle and detec the cable length to provide different power.

Function name:

Power Saving

Function description:

The function using "ActiPHY Power Management" and "PerfectReach Power Management" to save the switch's power consumption.

Power Saving

Select/Unselect All

Port	Power Saving
1	<input type="checkbox"/>
2	<input type="checkbox"/>
3	<input type="checkbox"/>
4	<input type="checkbox"/>
5	<input type="checkbox"/>
6	<input type="checkbox"/>
7	<input type="checkbox"/>
8	<input type="checkbox"/>
9	<input type="checkbox"/>
10	<input type="checkbox"/>
11	<input type="checkbox"/>
12	<input type="checkbox"/>

Fig. 3-16-1

Parameter description:

Power Saving:

The parameter will enable or disable to verify switches have the ability to consider the length of any Ethernet cable connected for adjustment of power usage accordingly. Shorter lengths require less power. link-down mode removes power for each port that does not have a device attached.

Default: Disable.

3-3. VLAN

The switch supports Tag-based VLAN (802.1Q) and Port-based VLAN. Support **4094 active VLANs and VLAN ID 1~4094**. VLAN configuration is used to partition your LAN into small ones as your demand. Properly configuring it, you can gain not only improving security and increasing performance but greatly reducing VLAN management.

3-3-1. VLAN Mode

Function name:

VLAN Mode Setting

Function description:

The VLAN Mode Selection function includes five modes: Port-based, Tag-based, Metro Mode, Double-tag and Disable, you can choose one of them by pulling down list and selecting an item. Then, click **<Apply>** button, the settings will take effect immediately.

VLAN Mode

VLAN Mode: Segment A

Segment	Set
1	Port 1 <=> Port 9
2	Port 2 <=> Port 10
3	Port 3 <=> Port 11
4	Port 4 <=> Port 12
5	Port 5 <=> Port 13
6	Port 6 <=> Port 14
7	Port 7 <=> Port 15
8	Port 8 <=> Port 16
9	Port 17 <=> Port 18
10	Port 19 <=> Port 20
11	Port 21 <=> Port 22
12	Port 23 <=> Port 24

Fig. 3-17

Parameter description:

VLAN Mode:

Port-based:

Port-based VLAN is defined by port. Any packet coming in or outgoing from any one port of a port-based VLAN will be accepted. No filtering criterion applies in port-based VLAN. The only criterion is the physical port you connect to. For example, for a port-based VLAN named PVLAN-1 contains port members Port 1&2&3&4. If you are on the port 1, you can communicate with port 2&3&4. If you are on the port 5, then you cannot talk to them. Each port-based VLAN you built up must be assigned a group name. This switch can support up to maximal 24 port-based VLAN groups.

Tag-based:

Tag-based VLAN identifies its member by VID. This is quite different from port-based VLAN. If there are any more rules in ingress filtering list or egress filtering list, the packet will be screened with more filtering criteria to determine if it can be forwarded. The switch supports supplement of 802.1q. For more details, please see the section VLAN in Chapter 3.

Each tag-based VLAN you built up must be assigned VLAN name and VLAN ID. **Valid VLAN ID is 1-4094**. User can create total up to **4094 Tag VLAN groups**.

Segment A :

The “Segment A” mode is a special function for **LAN Segmentation (Converter Mode)** application, it is working under VLAN function. When the segment mode enabled, there are max. up to 12 LAN segments on the switch and fixed two ports for each LAN segment and each LAN segment will be isolated. The fixed segment ports mapping as below:

Segment	Forwarding Port Mapping
1	Port 01 ↔ Port 09
2	Port 02 ↔ Port 10
3	Port 03 ↔ Port 11
4	Port 04 ↔ Port 12
5	Port 05 ↔ Port 13
6	Port 06 ↔ Port 14
7	Port 07 ↔ Port 15
8	Port 08 ↔ Port 16
9	Port 17 ↔ Port 18
10	Port 19 ↔ Port 20
11	Port 21 ↔ Port 22
12	Port 23 ↔ Port 24

Segment B :

The “Segment B” mode is a special function for **LAN Segmentation (Converter Mode)** application, it is working under VLAN function. When the segment mode enabled, there are max. up to 12 LAN segments on the switch and fixed two ports for each LAN segment and each LAN segment will be isolated. The fixed segment ports mapping as below:

Segment	Forwarding Port Mapping
1	Port 01 ↔ Port 02
2	Port 03 ↔ Port 04
3	Port 05 ↔ Port 06
4	Port 07 ↔ Port 08
5	Port 09 ↔ Port 10
6	Port 11 ↔ Port 12
7	Port 13 ↔ Port 14
8	Port 15 ↔ Port 16
9	Port 17 ↔ Port 18
10	Port 19 ↔ Port 20
11	Port 21 ↔ Port 22
12	Port 23 ↔ Port 24

The ports in the same LAN segment will forward any packet in the same segment ports, the received packets will be forwarded to the same segment port member without any change (for example: VLAN tag or untag frames). The L2 PDU will be passed through between two ports in the same LAN segment. (Including: STP, MSTP, GVRP, LACP,... ; Except 802.3X Pause Frame).

Notice: The following L2 switch functions can not work with LAN segmentation mode at the same time:

- GVRP
- MSTP/RSTP/STP
- IGMP Proxy and IGMP Snooping
- DHCP Snooping
- IP-MAC Binding
- LACP and Static Port Link Aggregation
- IEEE 802.1X

3-3-2. Tag-based Group

Function name:

Tag-based Group Configuration

Function description:

It shows the information of existed Tag-based VLAN Groups, You can also easily create, edit and delete a Tag-based VLAN group by pressing **<Add>**, **<Edit>** and **<Delete>** function buttons. User can add a new VLAN group by inputting a new VLAN name and VLAN ID.

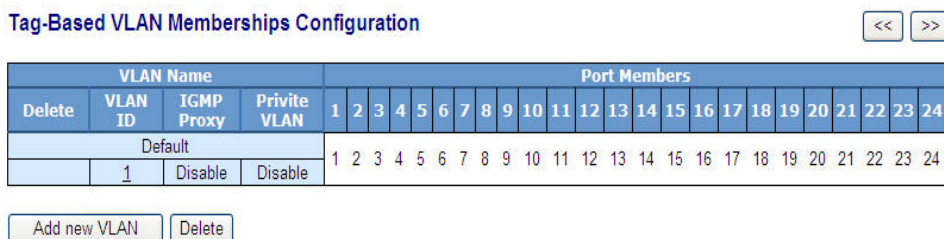

Fig. 3-18

Parameter description:

VLAN Name:

The name defined by administrator is associated with a VLAN group. **Valid letters are A-Z, a-z, 0-9, “ - “ and “ _ ” characters.** The maximal length is 15 characters.

VLAN ID:

VLAN identifier. Each tag-based VLAN group has a unique VID. It appears only in tag-based and Double-tag mode.

IGMP Proxy:

IGMP proxy enables the switch to issue IGMP host messages on behalf of hosts that the system discovered through standard IGMP interfaces. The system acts as a proxy for its hosts. This switch can be set IGMP function “**Enable**” or “**Disable**” by VLAN group. If the VLAN group IGMP proxy is disabled, the switch will stop the exchange of IGMP messages in the VLAN group members. If the VLAN group IGMP proxy is enabled, the switch will support the exchange of IGMP messages in the VLAN group members and follow up IGMP proxy router port configuration, which connects to a router closer to the root of the tree. This interface is the upstream interface. The router on the upstream interface should be running IGMP. You enable IGMP on the interfaces that connect the system to its hosts that are farther away from the root of the tree. These interfaces are known as downstream interfaces. Please refer to 3-15-1 for detail IGMP Proxy function description.

Member Port:

This is used to enable or disable if a port is a member of the new added VLAN, “Enable” means it is a member of the VLAN. Just tick the check box () beside the port x to enable it.

Add new VLAN:

Please click on **<Add new VLAN>** to create a new Tag-based VLAN. Input the VLAN name as well as VID, configure the SYM-VLAN function and choose the member by ticking the check box beside the port No., then, press the **<Apply>** button to have the setting taken effect.

Create VLAN Group

VLAN ID	<input type="text" value="2"/>																							
VLAN Name	<input type="text" value="VLAN2"/>																							
IGMP Proxy	<input type="checkbox"/> Enable																							
Private VLAN	<input checked="" type="checkbox"/> Enable																							
Member Port	1.	2.	3.	4.	5.	6.	7.	8.	9.	10.	11.	12.	13.	14.	15.	16.	17.	18.	19.	20.	21.	22.	23.	24.
	<input type="checkbox"/>	<input type="checkbox"/>	<input type="checkbox"/>	<input type="checkbox"/>	<input type="checkbox"/>	<input type="checkbox"/>	<input type="checkbox"/>	<input type="checkbox"/>	<input type="checkbox"/>	<input checked="" type="checkbox"/>	<input checked="" type="checkbox"/>	<input checked="" type="checkbox"/>	<input checked="" type="checkbox"/>	<input checked="" type="checkbox"/>	<input checked="" type="checkbox"/>	<input checked="" type="checkbox"/>	<input type="checkbox"/>	<input type="checkbox"/>	<input type="checkbox"/>	<input type="checkbox"/>	<input type="checkbox"/>	<input type="checkbox"/>	<input type="checkbox"/>	<input type="checkbox"/>

Fig. 3-19

Delete Group:

Just press the **<Delete>** button to remove the selected group entry from the Tag-based group table.

Tag-Based VLAN Memberships Configuration

VLAN Name				Port Members																							
Delete	VLAN ID	IGMP Proxy	Private VLAN	1	2	3	4	5	6	7	8	9	10	11	12	13	14	15	16	17	18	19	20	21	22	23	24
	1	Disable	Disable																								
	2	Disable	Enable	10																							

Fig. 3-20

Note: If you need use PVLAN(Private VLAN) function on Switch then you need follow up the process as below:

- Create a VLAN as primary VLAN and the VLAN ID is 2 and evoke the Private VLAN to enable Private VLAN service.
- Assign port member to the VLAN2

Create VLAN Group

VLAN ID	<input type="text" value="2"/>																							
VLAN Name	<input type="text" value="VLAN2"/>																							
IGMP Proxy	<input type="checkbox"/> Enable																							
Private VLAN	<input checked="" type="checkbox"/> Enable																							
Member Port	1.	2.	3.	4.	5.	6.	7.	8.	9.	10.	11.	12.	13.	14.	15.	16.	17.	18.	19.	20.	21.	22.	23.	24.
	<input type="checkbox"/>	<input type="checkbox"/>	<input type="checkbox"/>	<input type="checkbox"/>	<input type="checkbox"/>	<input type="checkbox"/>	<input type="checkbox"/>	<input type="checkbox"/>	<input type="checkbox"/>	<input checked="" type="checkbox"/>	<input checked="" type="checkbox"/>	<input checked="" type="checkbox"/>	<input checked="" type="checkbox"/>	<input checked="" type="checkbox"/>	<input checked="" type="checkbox"/>	<input checked="" type="checkbox"/>	<input type="checkbox"/>	<input type="checkbox"/>	<input type="checkbox"/>	<input type="checkbox"/>	<input type="checkbox"/>	<input type="checkbox"/>	<input type="checkbox"/>	<input type="checkbox"/>
	<input type="checkbox"/>	<input type="checkbox"/>	<input type="checkbox"/>	<input type="checkbox"/>	<input type="checkbox"/>	<input type="checkbox"/>	<input type="checkbox"/>	<input type="checkbox"/>	<input type="checkbox"/>	<input type="checkbox"/>	<input type="checkbox"/>	<input type="checkbox"/>	<input type="checkbox"/>	<input type="checkbox"/>	<input type="checkbox"/>	<input type="checkbox"/>	<input type="checkbox"/>	<input type="checkbox"/>	<input type="checkbox"/>	<input type="checkbox"/>	<input type="checkbox"/>	<input type="checkbox"/>	<input type="checkbox"/>	<input type="checkbox"/>

Fig. 3-20-1

3-3-3. Port-based Group

Function name:

Port-based Group Configuration

Function description:

It shows the information of the existed Port-based VLAN Groups. You can easily create, edit and delete a Port-based VLAN group by pressing **<Add>**, **<Edit>** and **<Delete>** function buttons. User can add a new VLAN group by inputting a new VLAN name.

VLAN Name		Port Members																							
Delete	Group	1	2	3	4	5	6	7	8	9	10	11	12	13	14	15	16	17	18	19	20	21	22	23	24
	Default																								
	1	1	2	3	4	5	6	7	8	9	10	11	12	13	14	15	16	17	18	19	20	21	22	23	24

Fig. 3-21

Parameter description:

VLAN Name:

The name defined by administrator is associated with a VLAN group. **Valid letters are A-Z, a-z, 0-9, “ - “ and “ _ ” characters.** The maximal length is 15 characters.

Member Port:

This is used to enable or disable if a port is a member of the new added VLAN, “Enable” means it is a member of the VLAN. Just tick the check box () beside the port x to enable it.

Add new VLAN:

Create a new Port-based VLAN. Input the VLAN name and choose the member by ticking the check box beside the port No., then, press the **<Apply>** button to have the setting taken effect.

Create VLAN Group

Group	2																							
VLAN Name	2																							
Member Port	1.	2.	3.	4.	5.	6.	7.	8.	9.	10.	11.	12.	13.	14.	15.	16.	17.	18.	19.	20.	21.	22.	23.	24.
	<input type="checkbox"/>	<input type="checkbox"/>	<input type="checkbox"/>	<input type="checkbox"/>	<input type="checkbox"/>	<input type="checkbox"/>	<input type="checkbox"/>	<input type="checkbox"/>	<input type="checkbox"/>	<input type="checkbox"/>	<input type="checkbox"/>	<input type="checkbox"/>	<input type="checkbox"/>	<input type="checkbox"/>	<input type="checkbox"/>	<input type="checkbox"/>	<input type="checkbox"/>	<input type="checkbox"/>	<input type="checkbox"/>	<input type="checkbox"/>	<input checked="" type="checkbox"/>	<input checked="" type="checkbox"/>	<input checked="" type="checkbox"/>	<input checked="" type="checkbox"/>

Fig. 3-22

Delete Group:

Just press the **<Delete>** button to remove the selected group entry from the Port-based group table.

Port-Based VLAN Memberships Configuration

VLAN Name		Port Members																							
Delete	Group	1	2	3	4	5	6	7	8	9	10	11	12	13	14	15	16	17	18	19	20	21	22	23	24
	Default	1	2	3	4	5	6	7	8	9	10	11	12	13	14	15	16	17	18	19	20	21	22	23	24
	2																					21	22	23	24
<input checked="" type="checkbox"/>	2																					21	22	23	24

Fig. 3-23

3-3-4. Ports

Function name:

VLAN Port Configuration

Function description:

In VLAN Tag Rule Setting, user can input VID number to each port. The range of VID number is from 1 to 4094. User also can choose ingress filtering rules to each port. There are two ingress filtering rules which can be applied to the switch. The Ingress Filtering Rule 1 is “forward only packets with VID matching this port’s configured VID”. The Ingress Filtering Rule 2 is “drop untagged frame”. You can also select the Role of each port as Access, Trunk, or Hybrid.

VLAN Port Configuration

Port #	VLAN Aware	Ingress Filtering	Frame Type	PVID	Role	Untag VID	Double Tag
1	<input type="checkbox"/>	<input type="checkbox"/>	All	1	Access	0	Disable
2	<input type="checkbox"/>	<input type="checkbox"/>	All	1	Access	0	Disable
3	<input type="checkbox"/>	<input type="checkbox"/>	All	1	Access	0	Disable
4	<input type="checkbox"/>	<input type="checkbox"/>	All	1	Access	0	Disable
5	<input type="checkbox"/>	<input type="checkbox"/>	All	1	Access	0	Disable
6	<input type="checkbox"/>	<input type="checkbox"/>	All	1	Access	0	Disable
7	<input type="checkbox"/>	<input type="checkbox"/>	All	1	Access	0	Disable
8	<input type="checkbox"/>	<input type="checkbox"/>	All	1	Access	0	Disable
9	<input type="checkbox"/>	<input type="checkbox"/>	All	1	Access	0	Disable
10	<input type="checkbox"/>	<input type="checkbox"/>	All	1	Access	0	Disable
11	<input type="checkbox"/>	<input type="checkbox"/>	All	1	Access	0	Disable
12	<input type="checkbox"/>	<input type="checkbox"/>	All	1	Access	0	Disable
13	<input type="checkbox"/>	<input type="checkbox"/>	All	1	Access	0	Disable
14	<input type="checkbox"/>	<input type="checkbox"/>	All	1	Access	0	Disable
15	<input type="checkbox"/>	<input type="checkbox"/>	All	1	Access	0	Disable
16	<input type="checkbox"/>	<input type="checkbox"/>	All	1	Access	0	Disable

Fig. 3-24

Parameter description:

Port 1-24:

Port number.

VLAN Aware:

Based on IEEE 802.1Q VLAN tag to forward packet

Ingress Filtering:

Discard other VLAN group packets, only forward this port joined VLAN group packets

Frame Type:

All: Forward all tagged and untagged packets

Tagged: Forward tagged packets only and discard untagged packets

PVID:

This PVID range will be 1-4094. Before you set a number x as PVID, you have to create a Tag-based VLAN with VID x. For example, if port x receives an untagged packet, the switch will apply the PVID (assume as VID y) of port x to tag this packet, the packet then will be forwarded as the tagged packet with VID y.

Role:

This is an egress rule of the port. Here you can choose Access, Trunk or Hybrid. Trunk means the outgoing packets must carry VLAN tag header. Access means the outgoing packets carry no VLAN tag header. If packets have double VLAN tags, one will be dropped and the other will still be left. As to Hybrid, it is similar to Trunk, and both of them will tag-out. When the port is set to Hybrid, its packets will be untagged out if the VID of the outgoing packets with tag is the same as the one in the field of Untag VID of this port.

Untag VID:

Valid range is 1~4094. It works only when Role is set to Hybrid.

Double Tag:

Double-tag mode belongs to the tag-based mode, however, it would treat all frames as the untagged ones, which means that tag with PVID will be added into all packets. Then, these packets will be forwarded as Tag-based VLAN. So, the incoming packets with tag will become the double-tag ones. Scroll to enable the function and default is Disable.

3-3-5. Port Isolation

Function name:

Port Isolation

Function description:

Port Isolation provides for an apparatus and method to isolate ports on layer 2 switches on the same VLAN to restrict traffic flow. The apparatus comprises a switch having said plurality of ports, each port configured as a protected port or a non-protected port. An address table memory stores an address table having a destination address and port number pair. A forwarding map generator generates a forwarding map which is responsive to a destination address of a data packet. The method for isolating ports on a layer 2 switch comprises configuring each of the ports on the layer 2 switch as a protected port or a non-protected port. A destination address on an data packet is matched with a physical address on said layer 2 switch and a forwarding map is generated for the data packet based upon the destination address on the data packet. The data packet is then sent to the plurality of ports pursuant to the forwarding map generated based upon whether the ingress port was configured as a protected or non-protected port.

Port Isolation Configuration

Port Number																							
1	2	3	4	5	6	7	8	9	10	11	12	13	14	15	16	17	18	19	20	21	22	23	24
<input type="checkbox"/>	<input type="checkbox"/>	<input type="checkbox"/>	<input type="checkbox"/>	<input type="checkbox"/>	<input type="checkbox"/>	<input type="checkbox"/>	<input type="checkbox"/>	<input type="checkbox"/>	<input checked="" type="checkbox"/>	<input checked="" type="checkbox"/>	<input checked="" type="checkbox"/>	<input checked="" type="checkbox"/>	<input checked="" type="checkbox"/>	<input checked="" type="checkbox"/>	<input type="checkbox"/>	<input type="checkbox"/>	<input type="checkbox"/>	<input type="checkbox"/>	<input type="checkbox"/>	<input type="checkbox"/>	<input type="checkbox"/>	<input type="checkbox"/>	<input type="checkbox"/>

Fig. 3-24-1

Parameter description:

Port 1-24:

Port number. To evoke the port which you want to enable the Port Isolation service.

Save:

Press the “**Save**” to complete the PVLAN configuration process.

3-3-6. Management

Function name:

Management

Function description:

To assign a specific VLAN for management purpose.



The image shows a configuration window titled "Management VLAN". Inside the window, there is a label "VLAN ID" next to a text input field containing the number "1". Below the input field is a green button labeled "Apply".

Fig. 3-25

Parameter description:

VID: Specific Management VLAN ID.

3-4. MAC

MAC Table Configuration gathers many functions, including MAC Table Information, MAC Table Maintenance, Static Forward, Static Filter and MAC Alias, which cannot be categorized to some function type. They are described below.

3-4-1. Mac Address Table

Function name:

MAC Address Table Information

Function Description:

This function can allow the user to set up the processing mechanism of MAC Table. An idle MAC address exceeding MAC Address Age-out Time will be removed from the MAC Table. **The range of Age-out Time is 10-1000000 seconds**, and the setup of this time will have no effect on static MAC addresses.

In addition, the learning limit of MAC maintenance is able to limit the amount of MAC that each port can learn.

The screenshot shows a configuration window titled "MAC Address Table Configuration". It is divided into two main sections: "Aging Configuration" and "MAC Table Learning".

Aging Configuration:

Age time	<input type="text" value="300"/>	seconds.
Disable automatic aging	<input type="checkbox"/>	

MAC Table Learning:

	Port Members																							
	1	2	3	4	5	6	7	8	9	10	11	12	13	14	15	16	17	18	19	20	21	22	23	24
Auto	<input checked="" type="radio"/>	<input checked="" type="radio"/>	<input checked="" type="radio"/>	<input checked="" type="radio"/>	<input checked="" type="radio"/>	<input checked="" type="radio"/>	<input checked="" type="radio"/>	<input checked="" type="radio"/>	<input checked="" type="radio"/>	<input checked="" type="radio"/>	<input checked="" type="radio"/>	<input checked="" type="radio"/>	<input checked="" type="radio"/>	<input checked="" type="radio"/>	<input checked="" type="radio"/>	<input checked="" type="radio"/>	<input checked="" type="radio"/>	<input checked="" type="radio"/>	<input checked="" type="radio"/>	<input checked="" type="radio"/>	<input checked="" type="radio"/>	<input checked="" type="radio"/>	<input checked="" type="radio"/>	<input checked="" type="radio"/>
Disable	<input type="radio"/>	<input type="radio"/>	<input type="radio"/>	<input type="radio"/>	<input type="radio"/>	<input type="radio"/>	<input type="radio"/>	<input type="radio"/>	<input type="radio"/>	<input type="radio"/>	<input type="radio"/>	<input type="radio"/>	<input type="radio"/>	<input type="radio"/>	<input type="radio"/>	<input type="radio"/>	<input type="radio"/>	<input type="radio"/>	<input type="radio"/>	<input type="radio"/>	<input type="radio"/>	<input type="radio"/>	<input type="radio"/>	<input type="radio"/>
Secure	<input type="radio"/>	<input type="radio"/>	<input type="radio"/>	<input type="radio"/>	<input type="radio"/>	<input type="radio"/>	<input type="radio"/>	<input type="radio"/>	<input type="radio"/>	<input type="radio"/>	<input type="radio"/>	<input type="radio"/>	<input type="radio"/>	<input type="radio"/>	<input type="radio"/>	<input type="radio"/>	<input type="radio"/>	<input type="radio"/>	<input type="radio"/>	<input type="radio"/>	<input type="radio"/>	<input type="radio"/>	<input type="radio"/>	<input type="radio"/>

At the bottom of the window are "Save" and "Reset" buttons.

Fig. 3-26

Parameter description:

Aging Time:

Delete a MAC address idling for a period of time from the MAC Table, which will not affect static MAC address. Range of MAC Address Aging Time is 10-1000000 seconds. The default Aging Time is 300 seconds.

Disable automatic aging:

Stop the MAC table aging timer, the learned MAC address will not age out automatically

Auto:

Enable this port MAC address dynamic learning mechanism.

Disable:

Disable this port MAC address dynamic learning mechanism, only support static MAC address setting.

Secure:

Disable this port MAC address dynamic learning mechanism and copy the dynamic learning packets to CPU

Save:

Save MAC Address Table configuration

Reset:

Reset MAC Address Table configuration

3-4-2. Static Filter

Function name:

Static Filter

Function Description:

Static Filter is a function that denies the packet forwarding if the packet's MAC Address is listed in the filtering Static Filter table. User can very easily maintain the table by filling in MAC Address, VID (VLAN ID) and Alias fields individually. User also can delete the existed entry by clicking **<Delete>** button.

The screenshot shows a web interface titled "Static Filter". At the top, there are three input fields: "MAC" (with a template of six boxes separated by hyphens), "VID", and "Alias". Below these fields is an "Add" button. At the bottom, there is a table with the following data:

No	MAC	VID	Alias
1	00-40-C7-D6-00-02	1	admin

Fig. 3-27

Parameter description:

MAC:

It is a six-byte long Ethernet hardware address and usually expressed by hex and separated by hyphens. For example,

00 – 40 - C7 - D6 – 00 - 02

VID:

VLAN identifier. This will be filled only when tagged VLAN is applied. Valid range is 1 ~ 4094.

Alias:

MAC alias name you assign.

3-4-3. Static Forward

Function Name:

Static Forward

Function Description:

Static Forward is a function that allows the user in the static forward table to access a specified port of the switch. Static Forward table associated with a specified port of a switch is set up by manually inputting MAC address and its alias name.

When a MAC address is assigned to a specific port, all of the switch's traffics sent to this MAC address will be forwarded to this port.

For adding a MAC address entry in the allowed table, you just need to fill in four parameters: MAC address, associated port, VID and Alias. Just select the existed MAC address entry you want and click **<Delete>** button, you also can remove it.

The screenshot shows a web interface titled "Static Forward". At the top, there are four input fields: "MAC" (with a placeholder " - - - - -"), "Port No", "VID", and "Alias". Below these fields is an "Add" button. At the bottom, there is a table with the following data:

No	MAC	Port	VID	Alias
1	00-40-C7-D6-00-01	2	3	guest

Fig. 3-28

Parameter description:

MAC:

It is a six-byte long Ethernet hardware address and usually expressed by hex and separated by hyphens. For example,

00 – 40 - C7 - D6 – 00 - 01

Port No:

Port number of the switch. It is 1 ~24.

VID:

VLAN identifier. This will be filled only when tagged VLAN is applied. Valid range is 1 ~ 4094.

Alias:

MAC alias name you assign.

3-4-4. MAC Alias

Function name:

MAC Alias

Function description:

MAC Alias function is used to let you assign MAC address a plain English name. This will help you tell which MAC address belongs to which user in the illegal access report. At the initial time, it shows all pairs of the existed alias name and MAC address.

There are three MAC alias functions in this function folder, including MAC Alias Add, MAC Alias Edit and MAC Alias Delete. You can click **<Create/Edit>** button to add/modify a new or an existed alias name for a specified MAC address, or mark an existed entry to delete it. Alias name must be composed of A-Z, a-z and 0-9 only and has a maximal length of 15 characters.

No	MAC	Alias
1	00-40-C7-D6-00-02	admin
2	00-40-C7-D6-00-01	guest
3	00-40-C7-D6-00-03	john

Fig. 3-29

Parameter description:

MAC Address:

It is a six-byte long Ethernet hardware address and usually expressed by hex and separated by hyphens. For example,

00 – 40 - C7 - D6 – 00 - 01

Alias:

MAC alias name you assign.

Note: *If there are too many MAC addresses learned in the table, we recommend you inputting the MAC address and alias name directly.*

3-4-5. MAC Table

Function name:

Dynamic MAC Table

Function Description:

Display the static or dynamic learning MAC entry and the state for the selected port.

Dynamic MAC Table			Port Members																							
Type	VLAN	MAC Address	1	2	3	4	5	6	7	8	9	10	11	12	13	14	15	16	17	18	19	20	21	22	23	24
Dynamic	1	00-02-B3-B1-01-C1	1																							
Dynamic	1	00-06-29-D5-80-35	1																							
Dynamic	1	00-0D-60-EC-68-7A	1																							
Dynamic	1	00-40-C7-EA-50-57	1																							
Dynamic	1	00-40-C7-EE-00-DE																					21			
Dynamic	1	00-60-6E-CF-1F-94	1																							
Dynamic	1	88-62-37-89-52-36	1																							
Static	1	FF-FF-FF-FF-FF-FF	1	2	3	4	5	6	7	8	9	10	11	12	13	14	15	16	17	18	19	20	21	22	23	24

Fig. 3-30

Parameter description:

Type:

Dynamic or Static.

VLAN:

VLAN identifier. This will be filled only when tagged VLAN is applied. Valid range is 1 ~ 4094.

MAC address:

Display the MAC address of one entry you selected from the searched MAC entries table.

Port:

The port that exists in the searched MAC Entry.

Refresh:

Refresh function can help you to see current MAC Table status.

Clear:

To clear the selected entry.

Previous Page:

Move to the previous page.

Next Page:

Move to the next page.

3-5. GVRP

GVRP is an application based on Generic Attribute Registration Protocol (GARP), mainly used to automatically and dynamically maintain the group membership information of the VLANs. The GVRP offers the function providing the VLAN registration service through a GARP application. It makes use of GARP Information Declaration (GID) to maintain the ports associated with their attribute database and GARP Information Propagation (GIP) to communicate among switches and end stations. With GID information and GIP, GVRP state machine maintain the contents of Dynamic VLAN Registration Entries for each VLAN and propagate these information to other GVRP-aware devices to setup and update their knowledge database, the set of VLANs associated with currently active members, and through which ports these members can be reached.

In GVRP Configuration function folder, there are three functions supported, including GVRP Config, GVRP Counter and GVRP Group explained below.

3-5-1. Config

Function name:

GVRP Configuration

Function description:

In the function of GVRP Config, it is used to configure each port's GVRP operation mode, in which there are seven parameters needed to be configured described below.

GVRP Configuration

GVRP State Disabled ▾ Apply

Port	Join Time	Leave Time	LeaveAll Time	Default Applicant Mode	Default Registrar Mode	Restricted Mode
1	20	60	1000	Normal ▾	Normal ▾	Disabled ▾
2	20	60	1000	Normal ▾	Normal ▾	Disabled ▾
3	20	60	1000	Normal ▾	Normal ▾	Disabled ▾
4	20	60	1000	Normal ▾	Normal ▾	Disabled ▾
5	20	60	1000	Normal ▾	Normal ▾	Disabled ▾
6	20	60	1000	Normal ▾	Normal ▾	Disabled ▾
7	20	60	1000	Normal ▾	Normal ▾	Disabled ▾
8	20	60	1000	Normal ▾	Normal ▾	Disabled ▾
9	20	60	1000	Normal ▾	Normal ▾	Disabled ▾
10	20	60	1000	Normal ▾	Normal ▾	Disabled ▾
11	20	60	1000	Normal ▾	Normal ▾	Disabled ▾
12	20	60	1000	Normal ▾	Normal ▾	Disabled ▾
13	20	60	1000	Normal ▾	Normal ▾	Disabled ▾
14	20	60	1000	Normal ▾	Normal ▾	Disabled ▾
15	20	60	1000	Normal ▾	Normal ▾	Disabled ▾
16	20	60	1000	Normal ▾	Normal ▾	Disabled ▾
17	20	60	1000	Normal ▾	Normal ▾	Disabled ▾
18	20	60	1000	Normal ▾	Normal ▾	Disabled ▾
19	20	60	1000	Normal ▾	Normal ▾	Disabled ▾
20	20	60	1000	Normal ▾	Normal ▾	Disabled ▾
21	20	60	1000	Normal ▾	Normal ▾	Disabled ▾
22	20	60	1000	Normal ▾	Normal ▾	Disabled ▾
23	20	60	1000	Normal ▾	Normal ▾	Disabled ▾
24	20	60	1000	Normal ▾	Normal ▾	Disabled ▾

Apply

Fig. 3-31

Parameter description:

GVRP State:

This function is simply to let you enable or disable GVRP function. You can pull down the list and click the **<Downward>** arrow key to choose "Enable" or "Disable". Then, click the **<Apply>** button, the system will take effect immediately.

Join Time:

Used to declare the Join Time in unit of centisecond. Valid time range: 20 –100 centisecond, **Default: 20 centisecond.**

Leave Time:

Used to declare the Leave Time in unit of centisecond. Valid time range: 60 –300 centisecond, **Default: 60 centisecond.**

Leave All Time:

A time period for announcement that all registered device is going to be de-registered. If someone still issues a new join, then a registration will be kept in the switch. Valid range: 1000-5000 unit time, **Default: 1000 unit time.**

Default Applicant Mode:

The mode here means the type of participant. There are two modes, normal participant and non-participant, provided for the user's choice.

Normal:

It is Normal Participant. In this mode, the switch participates normally in GARP protocol exchanges. The default setting is Normal.

Non-Participant:

It is Non-Participant. In this mode, the switch does not send or reply any GARP messages. It just listens messages and reacts for the received GVRP BPDU.

Default Registrar Mode:

The mode here means the type of Registrar. There are three types of parameters for registrar administrative control value, normal registrar, fixed registrar and forbidden registrar, provided for the user's choice.

Normal:

It is Normal Registration. The Registrar responds normally to incoming GARP messages. The default setting is Normal.

Fixed:

It is Registration Fixed. The Registrar ignores all GARP messages, and all members remain in the registered (IN) state.

Forbidden:

It is Registration Forbidden. The Registrar ignores all GARP messages, and all members remain in the unregistered

(EMPTY) state.

Restricted Mode:

This function is used to restrict dynamic VLAN be created when this port received GVRP PDU. There are two modes, disable and enable, provided for the user's choice.

Disabled:

In this mode, the switch dynamic VLAN will be created when this port received GVRP PDU. The default setting is Normal.

Enabled:

In this mode, the switch does not create dynamic VLAN when this port received GVRP PDU. Except received dynamic VLAN message of the GVRP PDU is an existed static VLAN in the switch, this port will be added into the static VLAN members dynamically.

3-5-2. Counter

Function name:

GVRP Counter

Function description:

All GVRP counters are mainly divided into Received and Transmitted two categories to let you monitor the GVRP actions. Actually, they are GARP packets.

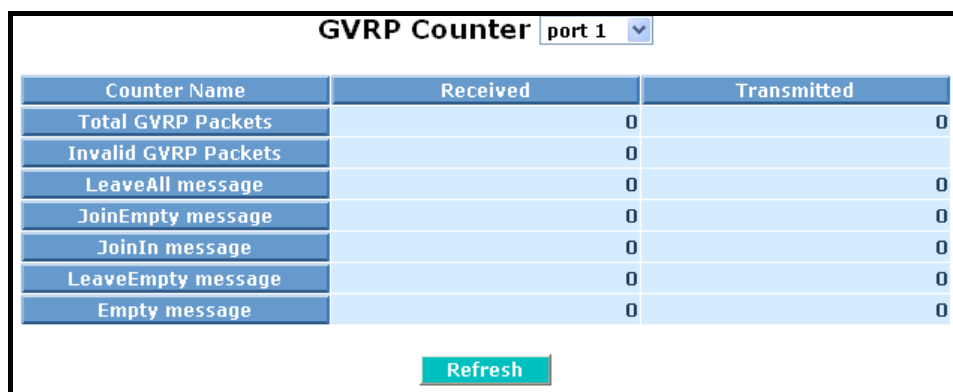

Counter Name	Received	Transmitted
Total GVRP Packets	0	0
Invalid GVRP Packets	0	0
LeaveAll message	0	0
JoinEmpty message	0	0
JoinIn message	0	0
LeaveEmpty message	0	0
Empty message	0	0

Fig. 3-32

Parameter description:

Received:

Total GVRP Packets:

Total GVRP BPDU is received by the GVRP application.

Invalid GVRP Packets:

Number of invalid GARP BPDU is received by the GARP application.

LeaveAll Message Packets:

Number of GARP BPDU with Leave All message is received by the GARP application.

JoinEmpty Message Packets:

Number of GARP BPDU with Join Empty message is received by the GARP application.

JoinIn Message Packets:

Number of GARP BPDU with Join In message is received by the GARP application.

LeaveEmpty Message Packets:

Number of GARP BPDU with Leave Empty message is received by the GARP application.

Empty Message Packets:

Number of GARP BPDU with Empty message is received by the GARP application.

Transmitted:

Total GVRP Packets:

Total GARP BPDU is transmitted by the GVRP application.

Invalid GVRP Packets:

Number of invalid GARP BPDU is transmitted by the GVRP application.

LeaveAll Message Packets:

Number of GARP BPDU with Leave All message is transmitted by the GARP application.

JoinEmpty Message Packets:

Number of GARP BPDU with Join Empty message is transmitted by the GARP application.

JoinIn Message Packets:

Number of GARP BPDU with Join In message is transmitted by the GARP application.

LeaveEmpty Message Packets:

Number of GARP BPDU with Leave Empty message is transmitted by the GARP application.

Empty Message Packets:

Number of GARP BPDU with Empty message is transmitted by the GARP application.

3-5-3. Group

Function name:

GVRP Group VLAN Information

Function description:

To show the dynamic group member and their information.



VID	Member Port
1	

Edit Administrative Control

Fig. 3-33

Parameter description:

VID:

VLAN identifier. When GVRP group creates, each dynamic VLAN group owns its VID. **Valid range is 1 ~ 4094.**

Member Port:

Those are the members belonging to the same dynamic VLAN group.

Edit Administrative Control:

When you create GVRP group, you can use Administrative Control function to change Applicant Mode and Registrar Mode of GVRP group member.

3-6. QoS(Quality of Service) Configuration

The switch support four QoS queues per port with strict or weighted fair queuing scheduling. There are 24 QoS Control Lists (QCL) for advance programmable QoS classification, based on IEEE 802.1p, Ethertype, VID, IPv4/IPv6 DSCP and UDP/TCP ports and ranges.

High flexibility in the classification of incoming frames to a QoS class. The QoS classification looks for information up to Layer 4, including IPv4 and IPv6 DSCP, IPv4 TCP/UDP port numbers, and user priority of tagged frames. This QoS classification mechanism is implemented in a QoS control list (QCL). The QoS class assigned to a frame is used throughout the device for providing queuing, scheduling, and congestion control guarantees to the frame according to what was configured for that specific QoS class.

The switch support advanced memory control mechanisms providing excellent performance of all QoS classes under any traffic scenario, including jumbo frame. A super priority queue with dedicated memory and strict highest priority in the arbitration. The ingress super priority queue allows traffic recognized as CPU traffic to be received and queued for transmission to the CPU even when all the QoS class queues are congested.

3-6-1. Ports

Function name:

Port QoS Configuration

Function description:

To configure each port QoS behavior. Four QoS queue per port with strict or weighted fair queuing scheduling. There are 24 QoS Control Lists (QCL) for advance programmable QoS classification, based on IEEE 802.1p, Ethertype, VID, IPv4/IPv6 DSCP and UDP/TCP ports and ranges.

Port QoS Configuration

Number of Classes 4 ▾

Port	Default Class	QCL	User Priority	Queuing Mode	Queue Weighted (Low:Normal:Medium:High)			
1	Low ▾	1 ▾	0 ▾	Strict Priority ▾	1 ▾	2 ▾	4 ▾	8 ▾
2	Low ▾	1 ▾	0 ▾	Strict Priority ▾	1 ▾	2 ▾	4 ▾	8 ▾
3	Low ▾	1 ▾	0 ▾	Strict Priority ▾	1 ▾	2 ▾	4 ▾	8 ▾
4	Low ▾	1 ▾	0 ▾	Strict Priority ▾	1 ▾	2 ▾	4 ▾	8 ▾
5	Low ▾	1 ▾	0 ▾	Strict Priority ▾	1 ▾	2 ▾	4 ▾	8 ▾
6	Low ▾	1 ▾	0 ▾	Strict Priority ▾	1 ▾	2 ▾	4 ▾	8 ▾
7	Low ▾	1 ▾	0 ▾	Strict Priority ▾	1 ▾	2 ▾	4 ▾	8 ▾
8	Low ▾	1 ▾	0 ▾	Strict Priority ▾	1 ▾	2 ▾	4 ▾	8 ▾
9	Low ▾	1 ▾	0 ▾	Strict Priority ▾	1 ▾	2 ▾	4 ▾	8 ▾
10	Low ▾	1 ▾	0 ▾	Strict Priority ▾	1 ▾	2 ▾	4 ▾	8 ▾
11	Low ▾	1 ▾	0 ▾	Strict Priority ▾	1 ▾	2 ▾	4 ▾	8 ▾
12	Low ▾	1 ▾	0 ▾	Strict Priority ▾	1 ▾	2 ▾	4 ▾	8 ▾

Fig. 3-34

Parameter description:

Number of Classes:

1 / 2 / 4

Port:

User can choose the port (1~24) respectively with Priority Class on Per Port Priority function.

Default Class:

User can set up High Priority or Low Priority for each port respectively.

Low / Normal / Medium / High

QCL:

The number of QCL rule 1~24, each port have to apply one of the QCL rule for QoS behavior

User priority:

The user priority value 0~7 (3 bits) is used as an index to the eight QoS class values for VLAN tagged or priority tagged frames.

Queuing Mode:

There are two Scheduling Method, Strict Priority and Weighted Fair. Default is Strict Priority. After you choose any of Scheduling Method, please click Apply button to be in operation.

Queue Weighted:

There are four queues per port and four classes weighted number (1 / 2 / 4 / 8) for each queues, you can select the weighted number when the scheduling method be set to "**Weighted Fair**" mode.

3-6-2. Qos Control List

Function name:

Qos Control List Configuration

Function description:

The switch support four QoS queues per port with strict or weighted fair queuing scheduling. There are **24 QoS Control Lists (QCL)** for advance programmable QoS classification, based on IEEE 802.1p, Ether Type, VID, IPv4/IPv6 DSCP and UDP/TCP ports and ranges.

QoS Control List Configuration

QCL #







QCE Type	Type Value	Traffic Class	
Ethernet Type	0xffff	Low	
VLAN ID	1	Low	
UDP/TCP Port	0 - 65535	Low	
DSCP	63	Low	
DSCP	63	Low	
ToS	---	---	
Tag Priority	---	---	

Fig. 3-35



QCE Configuration:

The QCL consists of 12 QoS Control Entries (QCEs) that are searched from the top of the list to the bottom of the list for a match. The first matching QCE determines the QoS classification of the frame. The QCE ordering is therefore important for the resulting QoS classification algorithm. If no matching QCE is found, the default QoS class is used in the port QoS configuration.

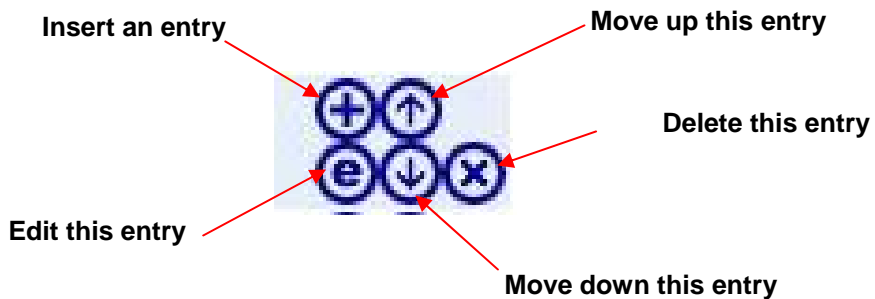
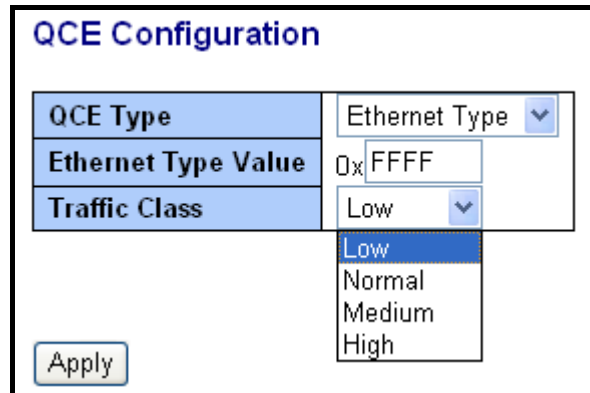

The dialog box titled "QCE Configuration" contains the following fields:

QCE Type	Ethernet Type
Ethernet Type Value	0x FFFF
Traffic Class	Low

An "Apply" button is located at the bottom left. A dropdown menu for "Traffic Class" is open, showing options: Low, Normal, Medium, and High.

Fig. 3-36

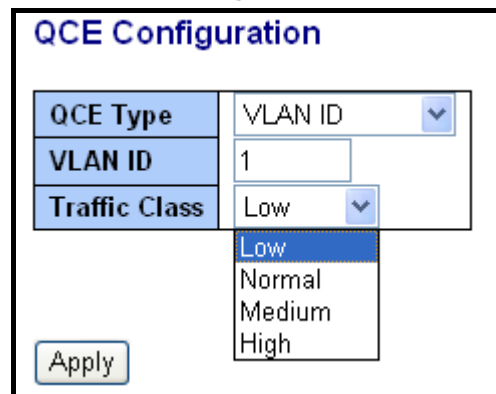

The dialog box titled "QCE Configuration" contains the following fields:

QCE Type	VLAN ID
VLAN ID	1
Traffic Class	Low

An "Apply" button is located at the bottom left. A dropdown menu for "Traffic Class" is open, showing options: Low, Normal, Medium, and High.

Fig. 3-37

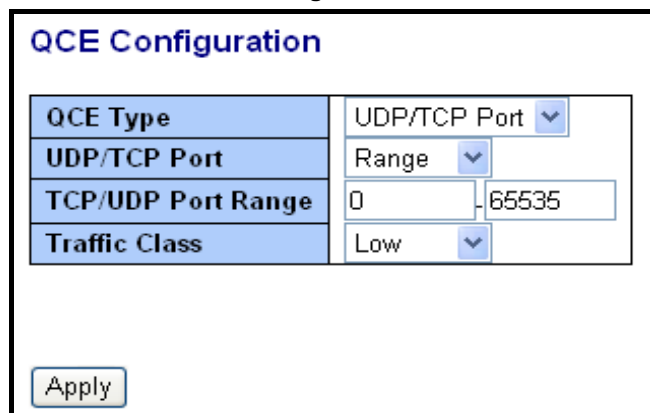

The dialog box titled "QCE Configuration" contains the following fields:

QCE Type	UDP/TCP Port
UDP/TCP Port	Range
TCP/UDP Port Range	0 - 65535
Traffic Class	Low

An "Apply" button is located at the bottom left.

Fig. 3-38

QCE Configuration

QCE Type	UDP/TCP Port <input type="button" value="v"/>
UDP/TCP Port	Specific <input type="button" value="v"/>
TCP/UDP Port No.	<input type="text" value="0"/>
Traffic Class	Low <input type="button" value="v"/>

Fig. 3-39

QCE Configuration

QCE Type	DSCP <input type="button" value="v"/>
DSCP Value	<input type="text" value="63"/>
Traffic Class	Low <input type="button" value="v"/>

Fig. 3-40

QCE Configuration

QCE Type	ToS <input type="button" value="v"/>
ToS Priority 0 Class	Low <input type="button" value="v"/>
ToS Priority 1 Class	Low <input type="button" value="v"/>
ToS Priority 2 Class	Low <input type="button" value="v"/>
ToS Priority 3 Class	Low <input type="button" value="v"/>
ToS Priority 4 Class	Low <input type="button" value="v"/>
ToS Priority 5 Class	Low <input type="button" value="v"/>
ToS Priority 6 Class	Low <input type="button" value="v"/>
ToS Priority 7 Class	Low <input type="button" value="v"/>

Fig. 3-41

QCE Configuration

QCE Type	Tag Priority
Tag Priority 0 Class	Normal
Tag Priority 1 Class	Low
Tag Priority 2 Class	Low
Tag Priority 3 Class	Normal
Tag Priority 4 Class	Medium
Tag Priority 5 Class	Medium
Tag Priority 6 Class	High
Tag Priority 7 Class	High

Apply

Fig. 3-42

Parameter description:

QCL#:

QCL number : 1~24

QCE Type:

Ethernet Type / VLAN ID / UDP/TCP Port / DSCP / ToS / Tag Priority

Ethernet Type Value:

The configurable range is **0x600~0xFFFF**. Well known protocols already assigned EtherType values. The commonly used values in the EtherType field and corresponding protocols are listed below:

Ethertype (Hexadecimal)	Protocol
0x0800	IP, Internet Protocol
0x0801	X.75 Internet
0x0802	NBS Internet
0x0803	ECMA Internet
0x0804	Chaosnet
0x0805	X.25 Level 3
0x0806	ARP, Address Resolution Protocol.
0x0808	Frame Relay ARP [RFC1701]

0x6559	Raw Frame Relay [RFC1701]
0x8035	DRARP, Dynamic RARP. RARP, Reverse Address Resolution Protocol.
0x8037	Novell Netware IPX
0x809B	EtherTalk (AppleTalk over Ethernet)
0x80D5	IBM SNA Services over Ethernet
0x 80F3	AARP, AppleTalk Address Resolution Protocol.
0x8100	IEEE Std 802.1Q - Customer VLAN Tag Type.
0x8137	IPX, Internet Packet Exchange.
0x 814C	SNMP, Simple Network Management Protocol.
0x86DD	IPv6, Internet Protocol version 6.
0x880B	PPP, Point-to-Point Protocol.
0x 880C	GSMP, General Switch Management Protocol.
0x8847	MPLS, Multi-Protocol Label Switching (unicast).
0x8848	MPLS, Multi-Protocol Label Switching (multicast).
0x8863	PPPoE, PPP Over Ethernet (Discovery Stage).
0x8864	PPPoE, PPP Over Ethernet (PPP Session Stage).
0x88BB	LWAPP, Light Weight Access Point Protocol.
0x88CC	LLDP, Link Layer Discovery Protocol.
0x8E88	EAPOL, EAP over LAN.
0x9000	Loopback (Configuration Test Protocol)
0xFFFF	reserved.

VLAN ID:

The configurable VID range: **1~4094**

UDP/TCP Port:

To select the UDP/TCP port classification method by Range or Specific.

Publication date: Oct., 2009

Revision A6

UDP/TCP Port Range:

The configurable ports range: **0~65535**

You can refer to following UDP/TCP port-numbers information.

<http://www.iana.org/assignments/port-numbers>

UDP/TCP Port No.:

The configurable specific port value: **0~65535**

DSCP Value:

The configurable DSCP value: **0~63**

Traffic Class:

Low / Normal / Medium / High

3-6-3.Rate Limiters

Function name:

Rate Limit Configuration

Function description:

Each port includes an ingress policer, and an egress shaper, which can limit the bandwidth of received and transmitted frames. Ingress policer or egress shaper operation is controlled per port in the Rate Limit Configuration.

Rate Limit Configuration

Port #	Policer Enabled	Policer Rate	Policer Unit	Shaper Enabled	Shaper Rate	Shaper Unit
1	<input type="checkbox"/>	500	kbps	<input type="checkbox"/>	500	kbps
2	<input type="checkbox"/>	500	kbps	<input type="checkbox"/>	500	kbps
3	<input type="checkbox"/>	500	kbps	<input type="checkbox"/>	500	kbps
4	<input type="checkbox"/>	500	kbps	<input type="checkbox"/>	500	kbps
5	<input type="checkbox"/>	500	kbps	<input type="checkbox"/>	500	kbps
6	<input type="checkbox"/>	500	kbps	<input type="checkbox"/>	500	kbps
7	<input type="checkbox"/>	500	kbps	<input type="checkbox"/>	500	kbps
8	<input type="checkbox"/>	500	kbps	<input type="checkbox"/>	500	kbps
9	<input type="checkbox"/>	500	kbps	<input type="checkbox"/>	500	kbps
10	<input type="checkbox"/>	500	kbps	<input type="checkbox"/>	500	kbps
11	<input type="checkbox"/>	500	kbps	<input type="checkbox"/>	500	kbps
12	<input type="checkbox"/>	500	kbps	<input type="checkbox"/>	500	kbps
13	<input type="checkbox"/>	500	kbps	<input type="checkbox"/>	500	kbps
14	<input type="checkbox"/>	500	kbps	<input type="checkbox"/>	500	kbps
15	<input type="checkbox"/>	500	kbps	<input type="checkbox"/>	500	kbps
16	<input type="checkbox"/>	500	kbps	<input type="checkbox"/>	500	kbps
17	<input type="checkbox"/>	500	kbps	<input type="checkbox"/>	500	kbps
18	<input type="checkbox"/>	500	kbps	<input type="checkbox"/>	500	kbps
19	<input type="checkbox"/>	500	kbps	<input type="checkbox"/>	500	kbps
20	<input type="checkbox"/>	500	kbps	<input type="checkbox"/>	500	kbps
21	<input type="checkbox"/>	500	kbps	<input type="checkbox"/>	500	kbps
22	<input type="checkbox"/>	500	kbps	<input type="checkbox"/>	500	kbps
23	<input type="checkbox"/>	500	kbps	<input type="checkbox"/>	500	kbps
24	<input type="checkbox"/>	500	kbps	<input type="checkbox"/>	500	kbps

Apply

Fig. 3-43

Parameter description:

Port #:

Port number.

Policer Enabled:

Policer enabled to limit ingress bandwidth by policer rate.

Policer Rate:

The configurable policer rate range:
500 Kbps ~ 1000000 Kbps
1 Mbps ~ 1000 Mbps

Policer Unit:

There are two units for ingress policer rate limit: **kbps / Mbps**

Shaper Enabled:

Shaper enabled to limit egress bandwidth by shaper rate.

Shaper Rate:

The configurable shaper rate range:
500 Kbps ~ 1000000 Kbps
1 Mbps ~ 1000 Mbps

Shaper Unit:

There are two units for egress shaper rate limit: **kbps / Mbps**

3-6-4.Storm Control

Function name:

Storm Control Configuration

Function description:

The switch support storm ingress policer control function to limit the Flooded, Multicast and Broadcast to prevent storm event happen.

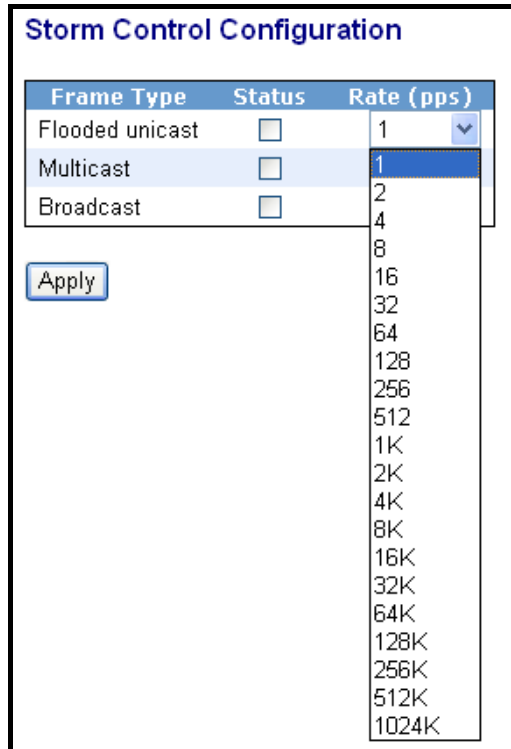

Fig. 3-44

Parameter description:

Frame Type:

There three frame types of storm can be controlled: Flooded unicast / Multicast / Broadcast

Status:

Enable/Disable Selection: means enabled, means disabled

Rate(pps):

Refer to the following rate configurable value list, the unit is Packet Per Second (pps).

1 / 2 / 4 / 8 / 16 / 32 / 64 / 128 / 256 / 512 / 1K / 2K / 4K / 8K / 16K / 32K / 64K / 128K / 256K / 512K / 1024K

3-6-5.Wizard

Function name:

Wizard

Function description:

The QCL configuration Wizard is targeted on user can easy to configure the QCL rules for QoS configuration. The wizard provide the typical network application rules, user can apply these application easily.

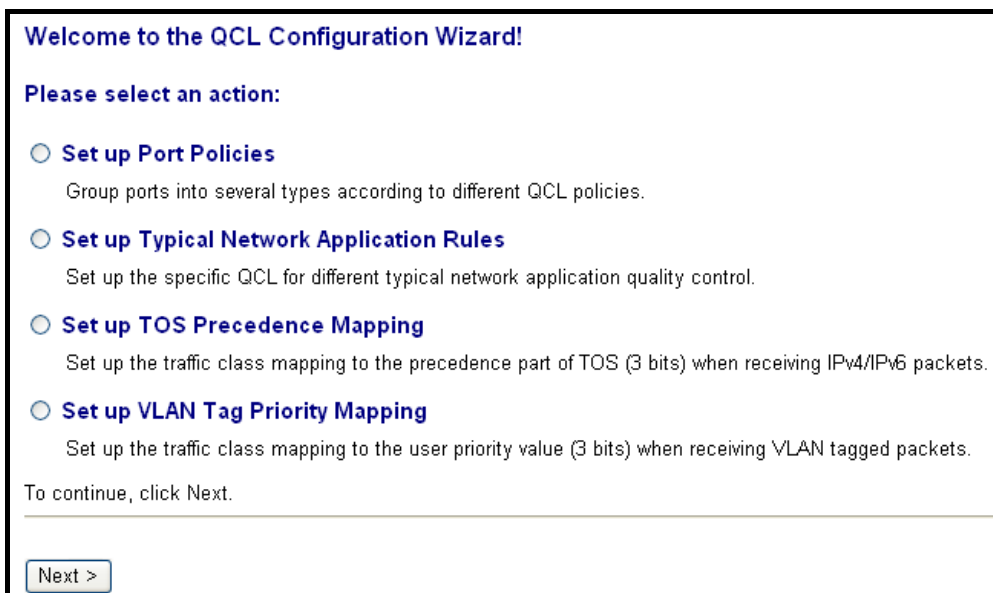

Fig. 3-45

Parameter description:

Please select an Action:

User need to select one of action from following items, then click on **<Next>** to finish QCL configuration:

- ◆ Set up Port Policies
- ◆ Set up Typical Network Application Rules
- ◆ Set up TOS Precedence Mapping
- ◆ Set up VLAN Tag Priority Mapping

Next:

Go to next step.

Cancel:

Abort current configuration back to previous step.

Back:

Back to previous screen.

Set up Policy Rules

Group ports into several types according to different QCL policies.

QCL ID	Port Members																							
	1	2	3	4	5	6	7	8	9	10	11	12	13	14	15	16	17	18	19	20	21	22	23	24
1	<input checked="" type="radio"/>	<input checked="" type="radio"/>	<input checked="" type="radio"/>	<input checked="" type="radio"/>	<input checked="" type="radio"/>	<input checked="" type="radio"/>	<input checked="" type="radio"/>	<input checked="" type="radio"/>	<input checked="" type="radio"/>	<input checked="" type="radio"/>	<input checked="" type="radio"/>	<input checked="" type="radio"/>	<input checked="" type="radio"/>	<input checked="" type="radio"/>	<input checked="" type="radio"/>	<input checked="" type="radio"/>	<input checked="" type="radio"/>	<input checked="" type="radio"/>	<input checked="" type="radio"/>	<input checked="" type="radio"/>	<input checked="" type="radio"/>	<input checked="" type="radio"/>	<input checked="" type="radio"/>	<input checked="" type="radio"/>
2	<input type="radio"/>	<input type="radio"/>	<input type="radio"/>	<input type="radio"/>	<input type="radio"/>	<input type="radio"/>	<input type="radio"/>	<input type="radio"/>	<input type="radio"/>	<input type="radio"/>	<input type="radio"/>	<input type="radio"/>	<input type="radio"/>	<input type="radio"/>	<input type="radio"/>	<input type="radio"/>	<input type="radio"/>	<input type="radio"/>	<input type="radio"/>	<input type="radio"/>	<input type="radio"/>	<input type="radio"/>	<input type="radio"/>	<input type="radio"/>
3	<input type="radio"/>	<input type="radio"/>	<input type="radio"/>	<input type="radio"/>	<input type="radio"/>	<input type="radio"/>	<input type="radio"/>	<input type="radio"/>	<input type="radio"/>	<input type="radio"/>	<input type="radio"/>	<input type="radio"/>	<input type="radio"/>	<input type="radio"/>	<input type="radio"/>	<input type="radio"/>	<input type="radio"/>	<input type="radio"/>	<input type="radio"/>	<input type="radio"/>	<input type="radio"/>	<input type="radio"/>	<input type="radio"/>	<input type="radio"/>
4	<input type="radio"/>	<input type="radio"/>	<input type="radio"/>	<input type="radio"/>	<input type="radio"/>	<input type="radio"/>	<input type="radio"/>	<input type="radio"/>	<input type="radio"/>	<input type="radio"/>	<input type="radio"/>	<input type="radio"/>	<input type="radio"/>	<input type="radio"/>	<input type="radio"/>	<input type="radio"/>	<input type="radio"/>	<input type="radio"/>	<input type="radio"/>	<input type="radio"/>	<input type="radio"/>	<input type="radio"/>	<input type="radio"/>	<input type="radio"/>
5	<input type="radio"/>	<input type="radio"/>	<input type="radio"/>	<input type="radio"/>	<input type="radio"/>	<input type="radio"/>	<input type="radio"/>	<input type="radio"/>	<input type="radio"/>	<input type="radio"/>	<input type="radio"/>	<input type="radio"/>	<input type="radio"/>	<input type="radio"/>	<input type="radio"/>	<input type="radio"/>	<input type="radio"/>	<input type="radio"/>	<input type="radio"/>	<input type="radio"/>	<input type="radio"/>	<input type="radio"/>	<input type="radio"/>	<input type="radio"/>
6	<input type="radio"/>	<input type="radio"/>	<input type="radio"/>	<input type="radio"/>	<input type="radio"/>	<input type="radio"/>	<input type="radio"/>	<input type="radio"/>	<input type="radio"/>	<input type="radio"/>	<input type="radio"/>	<input type="radio"/>	<input type="radio"/>	<input type="radio"/>	<input type="radio"/>	<input type="radio"/>	<input type="radio"/>	<input type="radio"/>	<input type="radio"/>	<input type="radio"/>	<input type="radio"/>	<input type="radio"/>	<input type="radio"/>	<input type="radio"/>
7	<input type="radio"/>	<input type="radio"/>	<input type="radio"/>	<input type="radio"/>	<input type="radio"/>	<input type="radio"/>	<input type="radio"/>	<input type="radio"/>	<input type="radio"/>	<input type="radio"/>	<input type="radio"/>	<input type="radio"/>	<input type="radio"/>	<input type="radio"/>	<input type="radio"/>	<input type="radio"/>	<input type="radio"/>	<input type="radio"/>	<input type="radio"/>	<input type="radio"/>	<input type="radio"/>	<input type="radio"/>	<input type="radio"/>	<input type="radio"/>

Fig. 3-46 Set up Port Policies

Parameter description:

QCL ID:

QoS Control List (QCL): **1~24**

Port Member:

Port Member: 1~24

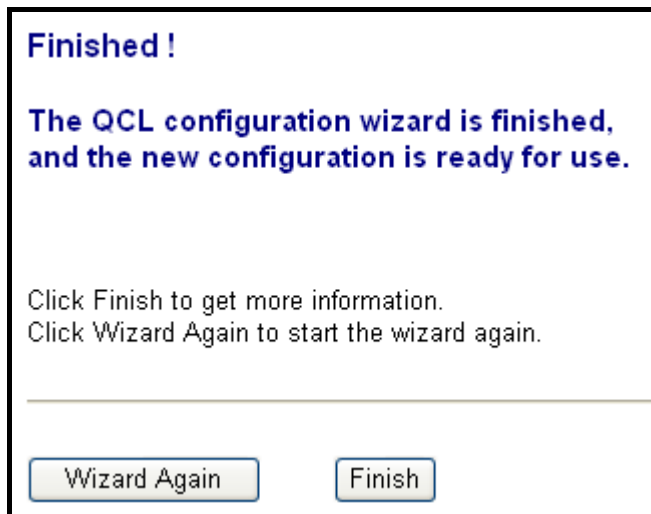

Fig. 3-47 Set up Port Policies

Parameter description:

Wizard Again:

Click on the **<Wizard Again>** , back to QCL Configuration Wizard.

Finish:

When you click on **<Finish>**, the parameters will be set according to the wizard configuration and shown on the screen, then ask you to click on

<Apply> for changed parameters confirmation.

Port QoS Configuration

Number of Classes: 4

Port	Default Class	QCL	User Priority	Queuing Mode	Queue Weighted (Low:Normal:Medium:High)			
1	Low	1	0	Strict Priority	1	2	4	8
2	Low	1	0	Strict Priority	1	2	4	8
3	Low	1	0	Strict Priority	1	2	4	8
4	Low	1	0	Strict Priority	1	2	4	8
5	Low	1	0	Strict Priority	1	2	4	8
6	Low	1	0	Strict Priority	1	2	4	8
7	Low	1	0	Strict Priority	1	2	4	8
8	Low	1	0	Strict Priority	1	2	4	8
9	Low	1	0	Strict Priority	1	2	4	8

Fig. 3-48 Set up Port Policies Finish

Set up Typical Network Application Rules

Set up the specific QCL for different typical network application quality control by selecting the network application type for your rule:

o Audio and Video

QuickTime 4 Server MSN Messenger Phone Yahoo Messenger Phone Napster Real Audio

o Games

Blizzard Battlenet (Diablo2 and StarCraft) Fighter Ace II Quake2 Quake3 MSN Game Zone

o User Definition

Ethernet Type VLAN ID UDP/TCP Port DSCP

Fig. 3-49 Set up Typical Network Application Rules

Set up Typical Network Application Rules

Set up the specific QCL for different typical network application quality control by selecting the network application type for your rule:

o Audio and Video

QuickTime 4 Server MSN Messenger Phone Yahoo Messenger Phone Napster Real Audio

o Games

Blizzard Battlenet (Diablo2 and StarCraft) Fighter Ace II Quake2 Quake3 MSN Game Zone

o User Definition

Ethernet Type VLAN ID UDP/TCP Port DSCP

Fig. 3-50 Set up Typical Network Application Rules

Set up Typical Network Application Rules

Set up the specific QCL for different typical network application quality control by selecting the network application type for your rule:

o Audio and Video

QuickTime 4 Server MSN Messenger Phone Yahoo Messenger Phone Napster Real Audio

o Games

Blizzard Battlenet (Diablo2 and StarCraft) Fighter Ace II Quake2 Quake3 MSN Game Zone

o User Definition

Ethernet Type 0x:fff VLAN ID 4095 UDP/TCP Port Specific DSCP 63

Specific
Range

Fig. 3-51 Set up Typical Network Application Rules

Parameter description:

Audio and Video:

QuickTime 4 Server / MSN Messenger Phone / Yahoo Messenger Phone / Napster / Real Audio

Games:

Blizzard Battlenet (Diablo2 and StarCraft) / Fighter Ace II / Quake2 / Quake3 / MSN Game Zone

User Definition:

Ethernet Type / VLAN ID / UDP/TCP Port / DSCP

Ethernet Type Value:

Type Range: **0x600~0xFFFF**

VLAN ID:

VLAN ID Range: **1~4094**

UDP/TCP Port:

Two Mode: **Range / Specific**

UDP/TCP Port Range:

Port Range: **0~65535**

UDP/TCP Port No.:

Port Range: **0~65535**

DSCP Value:

DSCP Value Range: **0~63**

Set up Typical Network Application Rules

According to your selection on the previous page, this wizard will create specific QCEs (QoS Control Entries) automatically.

First select the QCL ID for these QCEs, and then select the traffic class. Different parameter options are displayed, depending on your selection.

QCL ID	1
Traffic Class	Low

Fig. 3-52 Set up Typical Network Application Rules

Parameter description:

QCL ID:

QCL ID Range: 1~24

Traffic Class:

There are four classes: *Low / Normal / Medium / High*

Finished !

The QCL configuration wizard is finished, and the new configuration is ready for use.

Click Finish to get more information.
Click Wizard Again to start the wizard again.

Fig. 3-53 Set up Typical Network Application Rules

QoS Control List Configuration

QCL # 1

QCE Type	Type Value	Traffic Class	
UDP/TCP Port	6970 - 6970 (QuickTime 4 Server)	Low	+ ↑ e ↓ X
UDP/TCP Port	6901 - 6901 (MSN Messenger Phone)	Low	+ ↑ e ↓ X
UDP/TCP Port	5055 - 5055 (Yahoo Messenger Phone)	Low	+ ↑ e ↓ X
UDP/TCP Port	6699 - 6699 (Napster)	Low	+ ↑ e ↓ X
UDP/TCP Port	6970 - 7170 (Real Audio)	Low	+ ↑ e ↓ X +

Fig. 3-54 Set up Typical Network Application Rules Finish

QoS Control List Configuration

QCL # 1

QCE Type	Type Value	Traffic Class	
UDP/TCP Port	6112 - 6112 (Blizzard Battlenet)	Low	+ ↑ e ↓ X
UDP/TCP Port	50000 - 50100 (Fighter Ace II)	Low	+ ↑ e ↓ X
UDP/TCP Port	27910 - 27910 (Quake2)	Low	+ ↑ e ↓ X
UDP/TCP Port	27660 - 27662 (Quake3)	Low	+ ↑ e ↓ X
UDP/TCP Port	28800 - 29000 (MSN Game Zone)	Low	+ ↑ e ↓ X +

Fig. 3-55 Set up Typical Network Application Rules Finish

QoS Control List Configuration

QCL #

QCE Type	Type Value	Traffic Class	
UDP/TCP Port	6970 - 6970 (QuickTime 4 Server)	Low	+ ↑ e ↓ X
UDP/TCP Port	6112 - 6112 (Blizzard Battlenet)	Low	+ ↑ e ↓ X
Ethernet Type	0xffff	Low	+ ↑ e ↓ X
VLAN ID	4	Low	+ ↑ e ↓ X
UDP/TCP Port	0 - 444	Low	+ ↑ e ↓ X
DSCP	5	Low	+ ↑ e ↓ X +

Fig. 3-56 Set up Typical Network Application Rules Finish

Parameter description:

QCL #:

QoS Control List (QCL): 1~24

Set up TOS Precedence Mapping

Set up the traffic class mapping to the precedence part of TOS (3 bits) when receiving IPv4/IPv6 packets.

QCL ID	<input type="text" value="1"/>
TOS Precedence 0 Class	Low
TOS Precedence 1 Class	Low
TOS Precedence 2 Class	Low
TOS Precedence 3 Class	Low
TOS Precedence 4 Class	Low
TOS Precedence 5 Class	Low
TOS Precedence 6 Class	Low
TOS Precedence 7 Class	Low

Fig. 3-57 Set up TOS Precedence Mapping

Parameter description:

QCL ID:

QoS Control List (QCL): **1~24**

TOS Precedence 0~7 Class:

Low / Normal / Medium / High

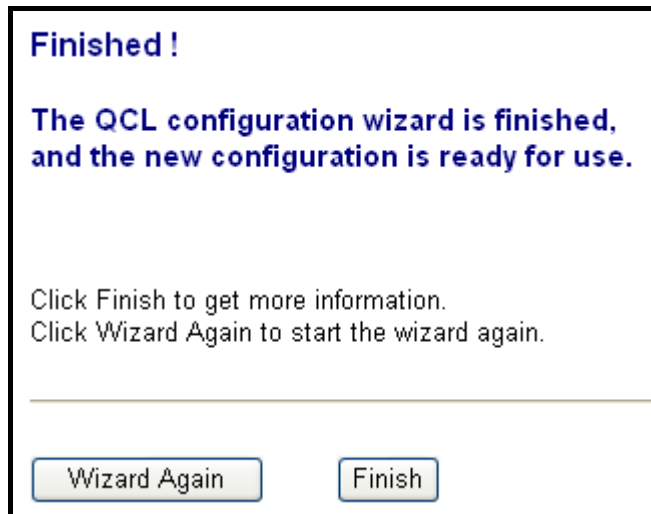

Fig. 3-58 Set up TOS Precedence Mapping



Fig. 3-59 Set up TOS Precedence Mapping Finish

Set up VLAN Tag Priority Mapping

Set up the traffic class mapping to the user priority value (3 bits) when receiving VLAN tagged packets.

QCL ID	1
Tag Priority 0 Class	Normal
Tag Priority 1 Class	Low
Tag Priority 2 Class	Low
Tag Priority 3 Class	Normal
Tag Priority 4 Class	Medium
Tag Priority 5 Class	Medium
Tag Priority 6 Class	High
Tag Priority 7 Class	High

Cancel < Back Next >

Fig. 3-60 Set up VLAN Tag Priority Mapping

Parameter description:

QCL ID:

QoS Control List (QCL): **1~24**

Tag Priority 0~7 Class:

Low / Normal / Medium / High

Finished !

The QCL configuration wizard is finished, and the new configuration is ready for use.

Click Finish to get more information.
Click Wizard Again to start the wizard again.

Wizard Again Finish

Fig. 3-61 Set up VLAN Tag Priority Mapping

QoS Control List Configuration

QCL # 1

QCE Type	Type Value	Traffic Class	
Tag Priority	---	---	

Fig. 3-62 Set up VLAN Tag Priority Mapping Finish

3-7. SNMP Configuration

Any Network Management System (NMS) running the Simple Network Management Protocol (SNMP) can manage the Managed devices equipped with SNMP agent, provided that the Management Information Base (MIB) is installed correctly on the managed devices. The SNMP is a protocol that is used to govern the transfer of information between SNMP manager and agent and traverses the Object Identity (OID) of the management Information Base (MIB), described in the form of SMI syntax. SNMP agent is running on the switch to response the request issued by SNMP manager.

Basically, it is passive except issuing the trap information. The switch supports a switch to turn on or off the SNMP agent. If you set the field SNMP "Enable", SNMP agent will be started up. All supported MIB OIDs, including RMON MIB, can be accessed via SNMP manager. If the field SNMP is set "Disable", SNMP agent will be de-activated, the related Community Name, Trap Host IP Address, Trap and all MIB counters will be ignored.

Function name:

SNMP Configuration

Function description:

This function is used to configure SNMP settings, community name, trap host and public traps as well as the throttle of SNMP. A SNMP manager must pass the authentication by identifying both community names, then it can access the MIB information of the target device. So, both parties must have the same community name. Once completing the setting, click **<Apply>** button, the setting takes effect.

SNMP Configuration				
SNMP	<input checked="" type="radio"/> Enable <input type="radio"/> Disable			
Get Community	<input type="text" value="public"/>			
Set Community	<input type="text" value="private"/>	Enable <input type="button" value="v"/>		
Trap Host 1 IP Address	<input type="text" value="0.0.0.0"/>	<input type="text" value="162"/>	Community	<input type="text" value="public"/>
Trap Host 2 IP Address	<input type="text" value="0.0.0.0"/>	<input type="text" value="162"/>	Community	<input type="text" value="public"/>
Trap Host 3 IP Address	<input type="text" value="0.0.0.0"/>	<input type="text" value="162"/>	Community	<input type="text" value="public"/>
Trap Host 4 IP Address	<input type="text" value="0.0.0.0"/>	<input type="text" value="162"/>	Community	<input type="text" value="public"/>
Trap Host 5 IP Address	<input type="text" value="0.0.0.0"/>	<input type="text" value="162"/>	Community	<input type="text" value="public"/>
Trap Host 6 IP Address	<input type="text" value="0.0.0.0"/>	<input type="text" value="162"/>	Community	<input type="text" value="public"/>
<input type="button" value="Apply"/>				

Fig. 3-63 Community and trap host setting

Parameters description:

SNMP:

The term SNMP here is used for the activation or de-activation of SNMP. Default is Enable.

Get/Set/Trap Community:

Community name is used as password for authenticating if the requesting network management unit belongs to the same community group. If they both don't have the same community name, they don't belong to the same group. Hence, the requesting network management unit can not access the device with different community name via SNMP protocol; If they both have the same community name, they can talk each other.

Community name is user-definable with a maximum length of 15 characters and is case sensitive. There is not allowed to put any blank in the community name string. Any printable character is allowable.

The community name for each function works independently. Each function has its own community name. Say, the community name for GET only works for GET function and can't be applied to other function such as SET and Trap.

Default SNMP function : **Enable**

Default community name for GET: **public**

Default community name for SET: **private**

Default community name for Trap: **public**

Default Set function : **Enable**

Default trap host IP address: **0.0.0.0**

Default port number :**162**

Trap:

In the switch, there are 6 trap hosts supported. Each of them has its own community name and IP address; is user-definable. To set up a trap host means to create a trap manager by assigning an IP address to host the trap message. In other words, the trap host is a network management unit with SNMP manager receiving the trap message from the managed switch with SNMP agent issuing the trap message. 6 trap hosts can prevent the important trap message from losing.

For each public trap, the switch supports the trap event Cold Start, Warm Start, Link Down, Link Up and Authentication Failure Trap. They can be enabled or disabled individually. When enabled, the corresponded trap will actively send a trap message to the trap host when a trap happens. If all public traps are disabled, no public trap message will be sent. As to the Enterprise (no. 6) trap is classified as private trap, which are listed in the Trap Alarm Configuration function folder.

Default for all public traps: **Enable.**

3-8. ACL

The GEFXL2P-SW24 switch access control list (ACL) is probably the most commonly used object in the IOS. It is used for packet filtering but also for selecting types of traffic to be analyzed, forwarded, or influenced in some way.

The ACLs are divided into EtherTypes. IPv4, ARP protocol, MAC and VLAN parameters etc. Here we will just go over the standard and extended access lists for TCP/IP. As you create ACEs for ingress classification, you can assign a policy for each port, the policy number is 1-8, however, each policy can be applied to any port. This makes it very easy to determine what type of ACL policy you will be working with.

3-8-1.Ports

Function name:

ACL Port Configuration

Function description:

The switch ACL function support **up to 128 Access Control Entries (ACEs)**, using the shared 128 ACEs for ingress classification. You can create an ACE and assign this ACE for each port with <Any> or assign this ACE for a policy or assign this ACE for a port. There are 8 policies, each port can select one of policy, then decides which of the following actions would take according to the packet's IPv4, EtherType, ARP Protocol, MAC Parameters and VLAN parameters:

- **Packet Deny or Permit**
- **Rate Limiter (Unit: pps)**
- **Port Copy (1 – 24)**

ACL Ports Configuration

Port #	Policy ID	Action	Rate Limiter ID	Port Copy	Counter
1	1	Permit	Disabled	Disabled	92459
2	1	Permit	Disabled	Disabled	0
3	1	Permit	Disabled	Disabled	0
4	1	Permit	Disabled	Disabled	0
5	1	Permit	Disabled	Disabled	0
6	1	Permit	Disabled	Disabled	0
7	1	Permit	Disabled	Disabled	0
8	1	Permit	Disabled	Disabled	0
9	1	Permit	Disabled	Disabled	0
10	1	Permit	Disabled	Disabled	0
11	1	Permit	Disabled	Disabled	0
12	1	Permit	Disabled	Disabled	0

Fig. 3-64

Parameter description:

Port #:

Port number: 1~24

Policy ID:

Policy ID range:1~8

Action:

Permit or Deny forwarding the met ACL packets

Rate Limiter ID:

Disabled: Disable Rate Limitation

Rate Limiter ID Range: 1~16. To select one of rate limiter ID for this port, it will limit met ACL packets by rate limiter ID configuration.

Port Copy:

Disabled: Disable to copy the met ACL packets to specific port

Port number: 1~24. Copy the met ACL packets to the selected port

Counter:

The counter will increase from initial value 0, when this port received one of the met ACL packet the counter value will increase +1

3-8-2.Rate Limiters

Function name:

ACL Rate Limiter Configuration

Function description:

There are 16 rate limiter ID. You can assign one of the limiter ID for each port. The rate limit configuration unit is Packet Per Second (pps).

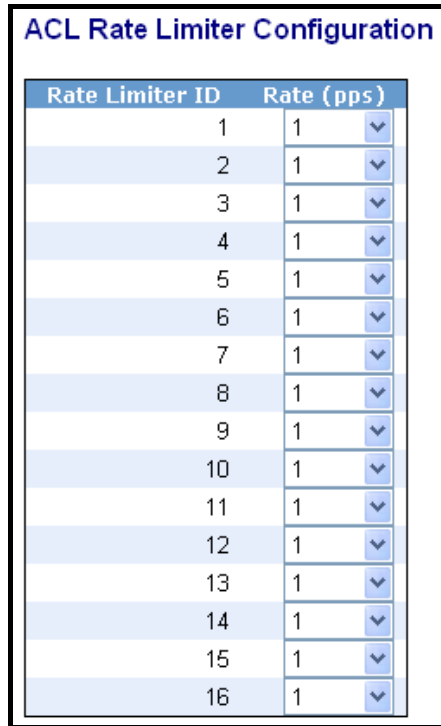

Rate Limiter ID	Rate (pps)
1	1
2	1
3	1
4	1
5	1
6	1
7	1
8	1
9	1
10	1
11	1
12	1
13	1
14	1
15	1
16	1

Fig. 3-65

Parameter description:

Rate Limiter ID:

ID Range: 1~16

Rate(pps):

1 / 2 / 4 / 8 / 16 / 32 / 64 / 128 / 256 / 512 / 1K / 2K / 4K / 8K / 16K / 32K / 64K / 128K / 256K / 512K / 1024K

3-8-3. Access Control List

Function name:

Access Control List

Function description:

The switch ACL function support **up to 128 Access Control Entries (ACEs)**, using the shared 128 ACEs for ingress classification. You can create an ACE and assign this ACE for each port with <Any> or assign this ACE for a policy or assign this ACE for a port. There are 8 policies, each port can select one of policy, then decides which of the Permit/Deny, Rate Limitation and Port Copy actions would take according to the ACL configuration packet's IPv4, EtherType, ARP Protocol, MAC Parameters and VLAN parameters.

Parameter description:

Ingress Port:

Configurable Range: Any / Policy 1-8 / Port 1-24

Any: Apply this ACE rule for each port ingress classification

Policy 1-8: Apply this ACE rule for specific policy

Port 1-24: Apply this ACE rule for specific port ingress classification

Access Control List Configuration Auto-refresh

Ingress Port	Frame Type	Action	Rate Limiter	Port Copy	Counters
Any	ARP	Deny	1	Disabled	27
Any	ARP	Permit	1	Disabled	43760
Any	ARP	Permit	3	Disabled	0
Any	ARP	Permit	1	Disabled	0
Any	ARP	Permit	Any	Disabled	0
Any	undefined	Deny	Any	Disabled	0
Any	EType	Deny	Any	Disabled	0
Any	IPv4/DHCP Client (Out)	Permit	Any	Disabled	26
Any	IPv4/DHCP Server (Out)	Permit	Any	Disabled	30
Any	IPv4/Other	Permit	3	Disabled	2643
Any	IPv4 DIP: 192.168.2.25	Permit	2	Disabled	9716
Any	undefined	Permit	3	Disabled	0
Any	EType	Permit	3	Disabled	0

Fig. 3-66 Ingress Port

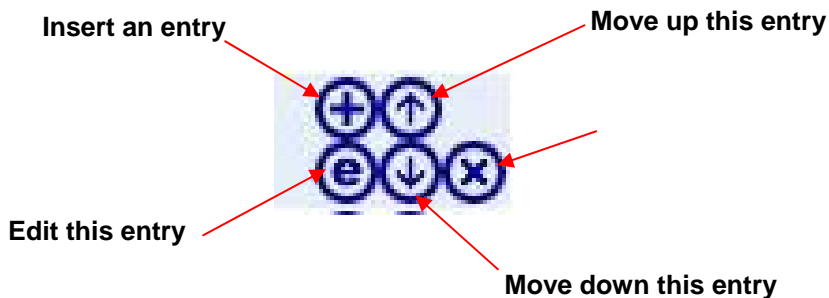

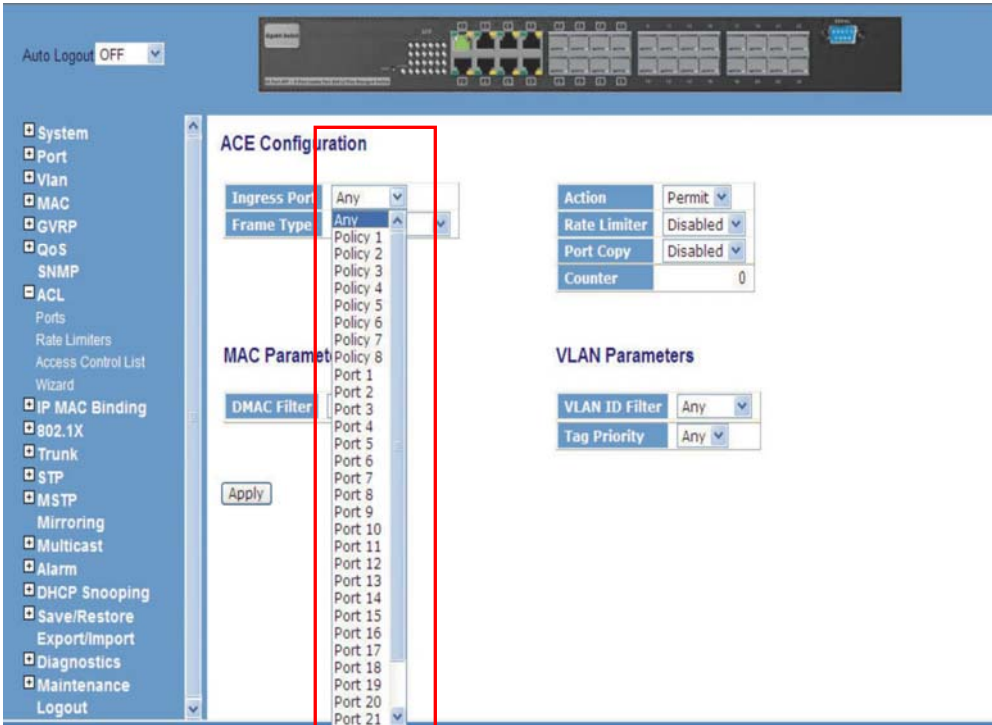

Fig. 3-67 Ingress Port

Access Control List Configuration

Ingress Port	Frame Type	Action	Rate Limiter	Port Copy	Counters	
Any	IPv4	Permit	Any	Disabled	16	+ ↑ e ↓ x
Any	ARP	Permit	Any	Disabled	0	+ ↑ e ↓ x
Any	EType	Permit	Any	Disabled	0	+ ↑ e ↓ x
Any	Any	Permit	Any	Disabled	432	+ ↑ e ↓ x +

Fig. 3-68

Parameter description:

Frame Type:

Range: **Any / Ethernet Type / ARP / IPv4**

Any: It is including all frame type

Ethernet Type: It is including all Ethernet frame type

ARP: It is including all ARP protocol frame type

IPv4: It is including all IPv4 protocol frame type

The screenshot shows the 'ACE Configuration' interface. A red box highlights the 'Ingress Port' and 'Frame Type' dropdown menus. The 'Frame Type' menu is open, showing options: Any, Ethernet Type, ARP, and IPv4. Other configuration options include Action (Permit), Rate Limiter (Disabled), Port Copy (Disabled), Counter (0), DMAC Filter (Any), VLAN ID Filter (Any), and Tag Priority (Any). An 'Apply' button is at the bottom left.

Fig. 3-69 Frame Type

The screenshot shows the 'ACE Configuration' interface with 'Frame Type' set to 'Ethernet Type'. It includes sections for 'MAC Parameters' (SMAC Filter and DMAC Filter, both set to Any) and 'Ethernet Type Parameters' (EtherType Filter set to Any). Other configuration options include Action (Permit), Rate Limiter (Disabled), Port Copy (Disabled), Counter (0), VLAN ID Filter (Any), and Tag Priority (Any). An 'Apply' button is at the bottom left.

Fig. 3-70

MAC Parameters

SMAC Filter	Specific ▾
SMAC Value	00-00-00-00-00-01
DMAC Filter	Any ▾

Fig. 3-71

Ethernet Type Parameters

EtherType Filter	Specific ▾
Ethernet Type Value	0x FFFF

Fig. 3-72

ACE Configuration

Ingress Port	Any ▾	Action	Permit ▾
Frame Type	ARP ▾	Rate Limiter	Disabled ▾
		Port Copy	Disabled ▾
		Counter	0

MAC Parameters

SMAC Filter	Any ▾
DMAC Filter	Any ▾

VLAN Parameters

VLAN ID Filter	Any ▾
Tag Priority	Any ▾

ARP Parameters

ARP/RARP	Any ▾
Request/Reply	Any ▾
Sender IP Filter	Any ▾
Target IP Filter	Any ▾

ARP SMAC Match	Any ▾
RARP DMAC Match	Any ▾
IP/Ethernet Length	Any ▾
IP	Any ▾
Ethernet	Any ▾

Fig. 3-73 ARP

ARP Parameters

ARP/RARP	Other
Request/Reply	Any
Sender IP Filter	ARP
Target IP Filter	RARP
	Other

Fig. 3-74 ARP

ARP Parameters

ARP/RARP	Any
Request/Reply	Reply
Sender IP Filter	Any
Target IP Filter	Request
	Reply

Fig. 3-75 ARP

ARP Parameters

ARP/RARP	Any
Request/Reply	Any
Sender IP Filter	Any
Target IP Filter	Any
	Host
	Network

Fig. 3-76 ARP

ARP Parameters

ARP/RARP	Any
Request/Reply	Any
Sender IP Filter	Host
Sender IP Address	192.168.1.1
Target IP Filter	Any

Fig. 3-77 ARP

ARP Parameters

ARP/RARP	Any
Request/Reply	Any
Sender IP Filter	Network
Sender IP Address	192.168.1.1
Sender IP Mask	255.255.255.0
Target IP Filter	Any

Fig. 3-78 ARP

ARP Parameters

ARP/RARP	Any
Request/Reply	Any
Sender IP Filter	Any
Target IP Filter	Any

Apply

- Any
- Host
- Network

Fig. 3-79 ARP

ARP Parameters

ARP/RARP	Any
Request/Reply	Any
Sender IP Filter	Any
Target IP Filter	Host
Target IP Address	192.168.1.254

Fig. 3-80 ARP

ARP Parameters

ARP/RARP	Any
Request/Reply	Any
Sender IP Filter	Any
Target IP Filter	Network
Target IP Address	192.168.1.254
Target IP Mask	255.255.255.0

Fig. 3-81 ARP

ARP SMAC Match	Any ▾
RARP DMAC Match	Any
IP/Ethernet Length	0 1
IP	Any ▾
Ethernet	Any ▾

Fig. 3-82 ARP

ARP SMAC Match	Any ▾
RARP DMAC Match	Any ▾
IP/Ethernet Length	Any
IP	0 1
Ethernet	Any ▾

Fig. 3-83 ARP

ARP SMAC Match	Any ▾
RARP DMAC Match	Any ▾
IP/Ethernet Length	Any ▾
IP	Any
Ethernet	0 1

Fig. 3-84 ARP

ARP SMAC Match	Any ▾
RARP DMAC Match	Any ▾
IP/Ethernet Length	Any ▾
IP	Any ▾
Ethernet	Any
	0 1

Fig. 3-85 ARP

ARP SMAC Match	Any ▾
RARP DMAC Match	Any ▾
IP/Ethernet Length	Any ▾
IP	Any ▾
Ethernet	Any ▾
	Any
	0 1

Fig. 3-86 ARP

ACE Configuration

Ingress Port	Any
Frame Type	IPv4

Action	Permit
Rate Limiter	Disabled
Port Copy	Disabled
Counter	0

MAC Parameters

DMAC Filter	Any
-------------	-----

VLAN Parameters

VLAN ID Filter	Any
Tag Priority	Any

IP Parameters

IP Protocol Filter	Any
IP TTL	Any
IP Fragment	Any
IP Option	Any
SIP Filter	Any

Fig. 3-87 IPv4

IP Parameters

IP Protocol Filter	Any
IP TTL	Any
IP Fragment	ICMP
IP Option	UDP
SIP Filter	TCP
DIP Filter	Other
	Any

Fig. 3-88 IPv4

ICMP Parameters

ICMP Type Filter	Any
ICMP Code Filter	Any

Fig. 3-89 IPv4

ICMP Parameters

ICMP Type Filter	Any
ICMP Code Filter	Any Specific

Fig. 3-90 IPv4

ICMP Parameters

ICMP Type Filter	Specific
ICMP Type Value	255
ICMP Code Filter	Any

Fig. 3-91 IPv4

ICMP Parameters

ICMP Type Filter	Any
ICMP Code Filter	Any Specific

Fig. 3-92 IPv4

ICMP Parameters

ICMP Type Filter	Any
ICMP Code Filter	Specific
ICMP Code Value	255

Fig. 3-93 IPv4

UDP Parameters

Source Port Filter	Any
Dest. Port Filter	Any

Fig. 3-94 IPv4

UDP Parameters

Source Port Filter	Any
Dest. Port Filter	Any Specific Range

Fig. 3-95 IPv4

UDP Parameters

Source Port Filter	Specific
Source Port No.	0
Dest. Port Filter	Any

Fig. 3-96 IPv4

UDP Parameters

Source Port Filter	Range
Source Port Range	0 - 65535
Dest. Port Filter	Any

Fig. 3-97 IPv4

UDP Parameters

Source Port Filter	Any
Dest. Port Filter	Any
	Any Specific Range

Fig. 3-98 IPv4

UDP Parameters

Source Port Filter	Any
Dest. Port Filter	Specific
Dest. Port No.	0

Fig. 3-99 IPv4

UDP Parameters

Source Port Filter	Any	▼
Dest. Port Filter	Range	▼
Dest. Port Range	0	65535

Fig. 3-100 IPv4

TCP Parameters

Source Port Filter	Any	▼
Dest. Port Filter	Any	▼
TCP FIN	Any	▼
TCP SYN	Any	▼
TCP RST	Any	▼
TCP PSH	Any	▼
TCP ACK	Any	▼
TCP URG	Any	▼

Fig. 3-101 IPv4

TCP Parameters

Source Port Filter	Any	▼
Dest. Port Filter	Any	▼
TCP FIN	Specific	▼
TCP SYN	Range	▼
TCP RST	Any	▼
TCP PSH	Any	▼
TCP ACK	Any	▼
TCP URG	Any	▼

Fig. 3-102 IPv4

TCP Parameters

Source Port Filter	Any ▾
Dest. Port Filter	Any ▾
TCP FIN	Any
TCP SYN	Specific
TCP RST	Range
TCP PSH	Any ▾
TCP ACK	Any ▾
TCP URG	Any ▾

Fig. 3-103 IPv4

TCP Parameters

Source Port Filter	Specific ▾
Source Port No.	0
Dest. Port Filter	Specific ▾
Dest. Port No.	0
TCP FIN	Any ▾
TCP SYN	Any ▾
TCP RST	Any ▾
TCP PSH	Any ▾
TCP ACK	Any ▾
TCP URG	Any ▾

Fig. 3-104 IPv4

TCP Parameters

Source Port Filter	Range ▾
Source Port Range	0 - 65535
Dest. Port Filter	Range ▾
Dest. Port Range	0 - 65535
TCP FIN	Any ▾
TCP SYN	Any ▾
TCP RST	Any ▾
TCP PSH	Any ▾
TCP ACK	Any ▾
TCP URG	Any ▾

Fig. 3-105 IPv4

TCP Parameters

Source Port Filter	Any ▾
Dest. Port Filter	Any ▾
TCP FIN	Any ▾
TCP SYN	Any
TCP RST	0 1
TCP PSH	Any ▾
TCP ACK	Any ▾
TCP URG	Any ▾

Fig. 3-106 IPv4

IP Parameters

IP Protocol Filter	Other ▾
IP Protocol Value	255
IP TTL	Any ▾
IP Fragment	Any ▾
IP Option	Any ▾
SIP Filter	Any ▾
DIP Filter	Any ▾

Fig. 3-107 IPv4

IP Parameters

IP Protocol Filter	Any ▾
IP TTL	Any ▾
IP Fragment	Any
IP Option	Non-zero Zero
SIP Filter	Any ▾
DIP Filter	Any ▾

Fig. 3-108 IPv4

IP Parameters

IP Protocol Filter	Any	▼
IP TTL	Any	▼
IP Fragment	Any	▼
IP Option	Any	▼
SIP Filter	Yes	▼
	No	
DIP Filter	Any	▼

Fig. 3-109 IPv4

IP Parameters

IP Protocol Filter	Any	▼
IP TTL	Any	▼
IP Fragment	Any	▼
IP Option	Any	▼
SIP Filter	Any	▼
	Yes	
DIP Filter	No	▼

Fig. 3-110 IPv4

IP Parameters

IP Protocol Filter	Any	▼
IP TTL	Any	▼
IP Fragment	Any	▼
IP Option	Any	▼
SIP Filter	Any	▼
DIP Filter	Any	▼
	Host	
	Network	

Apply

Fig. 3-111 IPv4

IP Parameters

IP Protocol Filter	Any ▾
IP TTL	Any ▾
IP Fragment	Any ▾
IP Option	Any ▾
SIP Filter	Host ▾
SIP Address	192.168.1.1
DIP Filter	Any ▾

Fig. 3-112 IPv4

IP Parameters

IP Protocol Filter	Any ▾
IP TTL	Any ▾
IP Fragment	Any ▾
IP Option	Any ▾
SIP Filter	Network ▾
SIP Address	192.168.1.1
SIP Mask	255.255.255.0
DIP Filter	Any ▾

Fig. 3-113 IPv4

IP Parameters

IP Protocol Filter	Any ▾
IP TTL	Any ▾
IP Fragment	Any ▾
IP Option	Any ▾
SIP Filter	Any ▾
DIP Filter	Any ▾

Apply

Any
Host
Network

Fig. 3-114 IPv4

IP Parameters

IP Protocol Filter	Any
IP TTL	Any
IP Fragment	Any
IP Option	Any
SIP Filter	Any
DIP Filter	Host
DIP Address	192.168.1.254

Fig. 3-115 IPv4

IP Parameters

IP Protocol Filter	Any
IP TTL	Any
IP Fragment	Any
IP Option	Any
SIP Filter	Any
DIP Filter	Network
DIP Address	192.168.1.254
DIP Mask	255.255.255.0

Fig. 3-116 IPv4

ACE Configuration

Ingress Port	Any
Frame Type	Any

Action	Permit
Rate Limiter	Deny
Port Copy	Permit
Counter	0

MAC Parameters

DMAC Filter	Any
-------------	-----

VLAN Parameters

VLAN ID Filter	Any
Tag Priority	Any

Apply

Fig. 3-117 Action

ACE Configuration

Ingress Port	Any
Frame Type	Any

MAC Parameters

DMAC Filter	Any
-------------	-----

Apply

Action	Permit
Rate Limiter	Disabled
Port Copy	Disabled
Counter	1
	2
	3
	4
	5
	6
	7
	8
	9
	10
	11
	12
	13
	14
	15
	16

VLAN Parameters

VLAN ID Filter	
Tag Priority	

Fig. 3-118 Rate Limiter

Ingress Port	Any
Frame Type	ARP

MAC Parameters

SMAC Filter	Any
DMAC Filter	Any

ARP Parameters

ARP/RARP	Other
Request/Reply	Any
Sender IP Filter	Any
Target IP Filter	Any

Apply

Action	Permit
Rate Limiter	Disabled
Port Copy	Disabled
Counter	Disabled
	1
	2
	3
	4
	5
	6
	7
	8
	9
	10
	11
	12
	13
	14
	15
	16
	17
	18
	19
	20
	21
	22
	23
	24

VLAN Parameters

VLAN ID Filter	
Tag Priority	

ARP SMAC Ma	
RARP DMAC M	
IP/Ethernet Le	
IP	
Ethernet	

Internet

Fig. 3-119 Port Copy

ACE Configuration

Ingress Port	Any
Frame Type	Any

Action	Permit
Rate Limiter	Disabled
Port Copy	Disabled
Counter	0

MAC Parameters

DMAC Filter	UC
-------------	----

Any
MC
BC
UC

Apply

VLAN Parameters

VLAN ID Filter	Any
Tag Priority	Any

Fig. 3-120 DMAC Filter

ACE Configuration

Ingress Port	Any
Frame Type	Any

Action	Permit
Rate Limiter	Disabled
Port Copy	Disabled
Counter	0

MAC Parameters

DMAC Filter	Any
-------------	-----

Apply

VLAN Parameters

VLAN ID Filter	Any
Tag Priority	Any

Fig. 3-121 VLAN ID Filter

VLAN Parameters

VLAN ID Filter	Specific
VLAN ID	1
Tag Priority	Any

Fig. 3-122 VLAN ID Filter

ACE Configuration

Ingress Port	Any
Frame Type	Any

Action	Permit
Rate Limiter	Disabled
Port Copy	Disabled
Counter	0

MAC Parameters

DMAC Filter	Any
--------------------	-----

VLAN Parameters

VLAN ID Filter	Any
Tag Priority	Any

0
1
2
3
4
5
6
7
Any

Apply

Fig. 3-123 Tag Priority

Function name:

ACE Configuration

Function description:

The switch ACL function support up to 128 Access Control Entries (ACEs), using the shared 128 ACEs for ingress classification. You can create an ACE and assign this ACE for each port with <Any> or assign this ACE for a policy or assign this ACE for a port. There are 8 policies, each port can select one of policy, then decides which of the Permit/Deny, Rate Limitation and Port Copy actions would take according to the ACL configuration packet's IPv4, EtherType, ARP Protocol, MAC Parameters and VLAN parameters.

Parameter description:

Ingress Port:

Range: **Any / Policy 1-8 / Port 1-24**

Any: Apply this ACE rule for each port ingress classification

Policy 1-8: Apply this ACE rule for specific policy

Port 1-24: Apply this ACE rule for specific port ingress classification

IP Protocol Filter:

Range: **Any / Ethernet Type / ARP / IPv4**

Any: It is including all frame type

Ethernet Type: It is including all Ethernet frame type

ARP: It is including all ARP protocol frame type

IPv4: It is including all IPv4 protocol frame type

MAC Parameters: (When Frame Type = Any)

DMAC Filter:

Range: **Any / MC / BC / UC**

Any: It is including all destination MAC address

MC: It is including all Multicast MAC address

BC: It is including all Broadcast MAC address

UC: It is including all Unicast MAC address

MAC Parameters: (When Frame Type = Ethernet Type)

SMAC Filter:

Range: **Any / Specific**

Any: It is including all source MAC address

Specific: It is according to SMAC Value specific the source MAC address

DMAC Filter:

Range: **Any / MC / BC / UC / Specific**

Any: It is including all destination MAC address

MC: It is including all Multicast MAC address

BC: It is including all Broadcast MAC address

UC: It is including all Unicast MAC address

Specific: It is according to DMAC Value specific the destination MAC address

MAC Parameters: (When Frame Type = ARP)

SMAC Filter:

Range: **Any / Specific**

Any: It is including all source MAC address

Specific: It is according to SMAC Value specific the source MAC address

DMAC Filter:

Range: **Any / MC / BC / UC**

Any: It is including all destination MAC address

MC: It is including all Multicast MAC address

BC: It is including all Broadcast MAC address

UC: It is including all Unicast MAC address

MAC Parameters: (When Frame Type = IPv4)

DMAC Filter:

Range: **Any / MC / BC / UC**

Any: It is including all destination MAC address

MC: It is including all Multicast MAC address

BC: It is including all Broadcast MAC address

UC: It is including all Unicast MAC address

Ether Type Parameters: (When Frame Type = Ethernet Type)

EtherType Filter:

Range: **Any / Specific**

Any: It is including all Ethernet frame type

Specific: It is according to specific Ethernet Type Value.

Ethernet Type Value:

The Ethernet Type Range: **0x600-0xFFFF**

ARP Parameters: (When Frame Type = ARP)**ARP/RARP:**

Range: **Any / ARP / RARP / Other**

Any: Including all ARP/RARP protocol frame types

ARP: Including all ARP protocol frame types

RARP: Including all RARP frame types

Other: Including other frame types except ARP/RARP protocol

Request/Reply:

Range: **Any / Request / Reply**

Any: Including all ARP/RARP Request and Reply

Request: Including all ARP/RARP request frames

Reply: Including all ARP/RARP reply frames

Sender IP Filter:

Range: **Any / Host / Network**

Any: Including all sender IP address

Host: Only one specific sender host IP address

Network: A specific IP subnet segment under the sender IP mask

Sender IP Address:

Default: **192.168.1.1**

Sender IP Mask:

Default: **255.255.255.0**

Target IP Filter:

Range: **Any / Host / Network**

Any: Including all target IP address

Host: Only one specific target host IP address

Network: A specific IP subnet segment under the target IP mask

Target IP Address:

Default: **192.168.1.254**

Target IP Mask:

Default: **255.255.255.0**

ARP SMAC Match:

Range: **Any / 0 / 1**

Any:

Both 0 and 1

0:

The ingress ARP frames where the source MAC address is not equal SMAC under MAC parameter setting

1:

The ingress ARP frames where the source MAC address is equal SMAC address under MAC parameter setting

RARP DMAC Match:

Range: **Any / 0 / 1**

Any:

Both 0 and 1

0:

The ingress RARP frames where the Destination MAC address is not equal DMAC address under MAC parameter setting

1:

The ingress RARP frames where the Destination MAC address is equal DMAC address under MAC parameter setting

IP/Ethernet Length:

Range: **Any / 0 / 1**

Any:

Both 0 and 1

0:

The ingress ARP/PARP frames where the Hardware size is not equal "0x6" or the Protocol size is not equal "0x4"

1:

The ingress ARP/PARP frames where the Hardware size is equal "0x6" and the Protocol size is "0x4"

IP:

Range: **Any / 0 / 1**

Any:

Both 0 and 1

0:

The ingress ARP/PARP frames where Protocol type is not equal "0x800"

1:

The ingress ARP/PARP frames where Protocol type is equal "0x800"

Ethernet:

Range: **Any / 0 / 1**

Any:

Both 0 and 1

0:

The ingress ARP/PARP frames where Hardware type is not equal "0x100"

1:

The ingress ARP/PARP frames where Hardware type is equal "0x100"

IP Parameters: (When Frame Type = IPv4 and IP Protocol Filter = Any)

IPTTL: (Time To Live)

How many routers a datagram can pass through. Each router decrements this value by 1 until it reaches 0 when the datagram is discarded. This keeps misrouted datagrams from remaining on the Internet forever

Range: **Any / Non-zero / Zero**

Any: Including all conditions for IPTTL

Non-Zero: Including IPTTL is Non-Zero

Zero: Including IPTTL is zero

IP Fragment: (IP Fragmentation Flag)

Controls datagram fragmentation together with the identification field. The flags indicate whether the datagram may be fragmented, whether the datagram is fragmented, and whether the current fragment is the final one.

Range: **Any / Yes / No**

Any: Including all IP fragment case

Yes: The ingress frame is fragmented packet

No: The ingress frames is not fragmented packet

IP Option:

A list of optional specifications for security restrictions, route recording, and source routing. Not every datagram specifies an options field.

Range: **Any / Yes / No**

Any: Including all IP option case

Yes: The ingress frame is specified IP options

No: The ingress frame is not specified IP options

SIP Filter: (SIP Source IP Address)

Range: **Any / Host / Network**

Any: Including all source IP address

Host: Only one specific source host IP address

Network: A specific IP subnet segment under the source IP mask

SIP Address:

Default: **192.168.1.1**

SIP Mask:

Default: **255.255.255.0**

DIP Filter: (DIP Destination IP Address)

Range: **Any / Host / Network**

Any: Including all destination IP address

Host: Only one specific destination host IP address

Network: A specific IP subnet segment under the destination IP mask

DIP Address:

Default: **192.168.1.254**

DIP Mask:

Default: **255.255.255.0**

IP Parameters: (Frame Type = IPv4 and IP Protocol Filter = ICMP)

ICMP Type Filter:

Range: **Any / Specific**

Any: Including all types of ICMP type values

Specific: According to following ICMP type value setting for ingress classification

ICMP Type Value:

Range: **0-255**

ICMP Code Filter:

Range: **Any / Specific**

Any: Including all of ICMP code values

Specific: According to following ICMP code value setting for ingress classification

ICMP Code Value:

Range: **0-255**

IP Parameters: (Frame Type = IPv4 and IP Protocol Filter = UDP)

Source Port Filter:

Range: **Any / Specific / Range**

Any: Including all UDP source ports

Specific:

According to following Source Port No. setting for ingress classification

Range:

According to following Source Port Range setting for ingress classification

Source Port No.:

Range: **0-65535**

Source Port Range.:

Range: **0-65535**

Dest. Port Filter:

Range: **Any / Specific / Range**

Any: Including all UDP destination ports

Specific:

According to following Dest. Port No. setting for ingress classification

Range:

According to following Dest. Port Range setting for ingress classification

Dest. Port No.: (Destination Port Number)

Range: **0-65535**

Dest. Port Range.: (Destination Port Range)

Range: **0-65535**

IP Parameters: (Frame Type = IPv4 and IP Protocol Filter = TCP)

Source Port Filter:

Range: **Any / Specific / Range**

Any: Including all TCP source ports

Specific:

According to following Source Port No. setting for ingress classification

Range:

According to following Source Port Range setting for ingress classification

Source Port No.:

Range: **0-65535**

Source Port Range.:

Range: **0-65535**

Dest. Port Filter:

Range: **Any / Specific / Range**

Any: Including all TCP destination ports

Specific:

According to following Dest. Port No. setting for ingress classification

Range:

According to following Dest. Port Range setting for ingress classification

Dest. Port No.:

Range: **0-65535**

Dest. Port Range.:

Range: **0-65535**

TCP FIN:

TCP Control Bit FIN: Means No more data from sender

Range: **Any / 0 / 1**

Any: Including all TCP FIN case

0: The TCP control bit FIN is 0

1: The TCP control bit FIN is 1

TCP SYN:

TCP Control Bit SYN: Means Synchronize sequence numbers

Range: **Any / 0 / 1**

Any: Including all TCP SYN case

0: The TCP control bit SYN is 0

1: The TCP control bit SYN is 1

TCP RST:

TCP Control Bit RST: Means Reset the connection

Range: **Any / 0 / 1**

Any: Including all TCP RST case

0: The TCP control bit RST is 0

1: The TCP control bit RST is 1

TCP PSH:

TCP Control Bit PSH: Means Push Function

Range: **Any / 0 / 1**

Any: Including all TCP PSH case

0: The TCP control bit PSH is 0

1: The TCP control bit PSH is 1

TCP ACK:

TCP Control Bit ACK: Means Acknowledgment field significant

Range: **Any / 0 / 1**

Any: Including all TCP ACK case

0: The TCP control bit ACK is 0

1: The TCP control bit ACK is 1

TCP URG:

TCP Control Bit URG: Means Urgent Pointer field significant

Range: **Any / 0 / 1**

Any: Including all TCP URG case

0: The TCP control bit URG is 0

1: The TCP control bit URG is 1

IP Protocol Value:

The IP Protocol Value is TCP options may occupy space at the end of the TCP header and are a multiple of 8 bits in length. Currently defined options include (kind indicated in octal):

0 - End of option list

1 - No-Operation

Range: **Any / 0 / 1**

Any: Including all IP protocol value case

0: The IP protocol value is 0

1: The IP protocol value is 1

IP Parameters: (Frame Type = IPv4 and IP Protocol Filter = Other)

IP Protocol Value

Default: **255**

IPTTL: (Time To Live)

How many routers a datagram can pass through. Each router decrements this value by 1 until it reaches 0 when the datagram is discarded. This keeps misrouted datagrams from remaining on the Internet forever

Range: **Any / Non-zero / Zero**

Any: Including all conditions for IPTTL

Non-Zero: Including IPTTL is Non-Zero

Zero: Including IPTTL is zero

IP Fragment: (IP Fragmentation Flag)

Controls datagram fragmentation together with the identification field. The flags indicate whether the datagram may be fragmented, whether the datagram is fragmented, and whether the current fragment is the final one.

Range: **Any / Yes / No**

Any: Including all IP fragment case

Yes: The ingress frame is fragmented packet

No: The ingress frames is not fragmented packet

IP Option:

A list of optional specifications for security restrictions, route recording, and source routing. Not every datagram specifies an options field.

Range: **Any / Yes / No**

Any: Including all IP option case

Yes: The ingress frame is specified IP options

No: The ingress frame is not specified IP options

SIP Filter: (SIP Source IP Address)

Range: **Any / Host / Network**

Any: Including all source IP address

Host: Only one specific source host IP address

Network: A specific IP subnet segment under the source IP mask

SIP Address:

Default: **192.168.1.1**

SIP Mask:

Default: **255.255.255.0**

DIP Filter: (DIP Destination IP Address)

Range: **Any / Host / Network**

Any: Including all destination IP address

Host: Only one specific destination host IP address

Network: A specific IP subnet segment under the destination IP mask

DIP Address:

Default: **192.168.1.254**

DIP Mask:

Default: **255.255.255.0**

VLAN Parameters:**VLAN ID Filter:**

Range: **Any / Specific**

Any: Including all VLAN IDs

Specific: According to following VLAN ID and Tag Priority setting for ingress classification

VLAN ID:

Range: **1-4094**

Tag Priority:

Range: **Any / 0-7**

Any: Including all Tag Priority values

0-7: The Tag Priority Value is one of number (0-7)

Action Parameters:

When the ingress frame meet above ACL ingress classification rule you can do the following actions:

Action:

Range: **Permit / Deny**

Permit:

Permit the met ACL ingress classification rule packets forwarding to other ports on the switch

Deny:

Discard the met ACL ingress classification rule packets

Rate Limiter:

Range: **Disabled / 1-16**

Disable: Disable Rate Limiter function

1-16: Apply the Rate Limiter Number setting for met ACL ingress rule packets

Port Copy:

Range: **Disabled / 1-24**

Disable: Disable the Port Copy function

1-24: The packets will be copied to the selected port when they met ACL ingress rule.

3-8-4.Wizard

Function name:

Wizard

Function description:

The wizard function is provide 4 type of typical application for user easy to configure their application with ACL function.

Parameter description:

Please select an Action:

Set up Policy Rules / Set up Port Policies / Set up Typical Network Application Rules / Set up Source MAC and Source IP Binding

Next:

Click on **<Next>** to confirm current setting and go to next step automatically.

Cancel:

Cancel current setting back to top layer in the ACL wizard function

Back:

Click on **<Back>** to back to previous step

Wizard Again:

Click on **<Wizard Again>** the UI will back to top layer in the wizard function

Finish:

Click in **<Finish>** to finish the ACL Wizard setting, it will according the selection items to change the related parameters, then you have to click on **<Apply>** to confirm the all changed parameters setting.

Welcome to the ACL Configuration Wizard!

Please select an action:

- Set up Policy Rules**
Set up the default policy rules for Client ports, Server ports, Network ports, and Guest ports.
- Set up Port Policies**
Group ports into several types according to different ACL policies.
- Set up Typical Network Application Rules**
Set up the specific ACL for different typical network application access control.
- Set up Source MAC and Source IP Binding**
Strictly control the network traffic by only allowing incoming frames that match the source MAC and source IP on specific ports.

To continue, click Next.

Fig. 3-124 Wizard

Welcome to the ACL Configuration Wizard!

Please select an action:

- Set up Policy Rules**
Set up the default policy rules for Client ports, Server ports, Network ports, and Guest ports.
- Set up Port Policies**
Group ports into several types according to different ACL policies.
- Set up Typical Network Application Rules**
Set up the specific ACL for different typical network application access control.
- Set up Source MAC and Source IP Binding**
Strictly control the network traffic by only allowing incoming frames that match the source MAC and source IP on specific ports.

To continue, click Next.

Fig. 3-125 Set up Policy Rules

Set up Policy Rules

Set up the default policy rules for Client ports, Server ports, Network ports and Guest ports.

Policy 2 for client ports : Limit the allowed rate of broadcast and multicast frames.
Policy 3 for server ports : Common server access only (DHCP, FTP, Mail, and WEB server).
Policy 4 for network ports : Limit the allowed rate of TCP SYN flooding and ICMP flooding.
Policy 5 for guest ports : Internet access only.

To continue, click Next.

Fig. 3-126 Set up Policy Rules

Finished !

The ACL configuration wizard is finished, and the new configuration is ready for use.

Click Finish to get more information.

Click Wizard Again to start the wizard again.

Wizard Again

Finish

Fig. 3-127 Set up Policy Rules

Ingress Port	Frame Type	Action	Rate Limiter	Port Copy	Counters	
Policy 2	Any	Permit	1	Disabled	0	+ e ↓ x
Policy 2	Any	Permit	1	Disabled	0	+ e ↓ x
Policy 3	ARP	Permit	Any	Disabled	0	+ e ↓ x
Policy 3	IPv4/FTP Control Port (In)	Permit	Any	Disabled	0	+ e ↓ x
Policy 3	IPv4/FTP Control Port (Out)	Permit	Any	Disabled	0	+ e ↓ x
Policy 3	IPv4/FTP Data Port (In)	Permit	Any	Disabled	0	+ e ↓ x
Policy 3	IPv4/FTP Data Port (Out)	Permit	Any	Disabled	0	+ e ↓ x
Policy 3	IPv4/POP3 (In)	Permit	Any	Disabled	0	+ e ↓ x
Policy 3	IPv4/POP3 (Out)	Permit	Any	Disabled	0	+ e ↓ x

Fig. 3-128 Set up Policy Rules Finish

Welcome to the ACL Configuration Wizard!

Please select an action:

Set up Policy Rules

Set up the default policy rules for Client ports, Server ports, Network ports, and Guest ports.

Set up Port Policies

Group ports into several types according to different ACL policies.

Set up Typical Network Application Rules

Set up the specific ACL for different typical network application access control.

Set up Source MAC and Source IP Binding

Strictly control the network traffic by only allowing incoming frames that match the source MAC and source IP on specific ports.

To continue, click Next.

Next >

Fig. 3-129 Set up Port Policies

Set up Port Policies

Group ports into several categories according to different ACL policies, for example, Client ports (work stations, laptops), Server ports (DHCP, Web, file server), Network ports (routers, switches), and Guest ports (laptops with Internet access only).

Policy ID	Port Members																							
	1	2	3	4	5	6	7	8	9	10	11	12	13	14	15	16	17	18	19	20	21	22	23	24
1 (Default)	<input checked="" type="checkbox"/>	<input type="checkbox"/>	<input type="checkbox"/>	<input type="checkbox"/>	<input type="checkbox"/>	<input type="checkbox"/>	<input type="checkbox"/>	<input type="checkbox"/>	<input checked="" type="checkbox"/>	<input checked="" type="checkbox"/>	<input checked="" type="checkbox"/>	<input checked="" type="checkbox"/>	<input checked="" type="checkbox"/>	<input checked="" type="checkbox"/>	<input checked="" type="checkbox"/>	<input checked="" type="checkbox"/>	<input checked="" type="checkbox"/>	<input checked="" type="checkbox"/>	<input checked="" type="checkbox"/>	<input checked="" type="checkbox"/>	<input checked="" type="checkbox"/>	<input checked="" type="checkbox"/>	<input checked="" type="checkbox"/>	<input checked="" type="checkbox"/>
2 (Client)	<input type="checkbox"/>	<input checked="" type="checkbox"/>	<input type="checkbox"/>	<input type="checkbox"/>	<input type="checkbox"/>	<input type="checkbox"/>	<input type="checkbox"/>	<input type="checkbox"/>	<input type="checkbox"/>	<input type="checkbox"/>	<input type="checkbox"/>	<input type="checkbox"/>	<input type="checkbox"/>	<input type="checkbox"/>	<input type="checkbox"/>	<input type="checkbox"/>	<input type="checkbox"/>	<input type="checkbox"/>	<input type="checkbox"/>	<input type="checkbox"/>	<input type="checkbox"/>	<input type="checkbox"/>	<input type="checkbox"/>	<input type="checkbox"/>
3 (Server)	<input type="checkbox"/>	<input type="checkbox"/>	<input checked="" type="checkbox"/>	<input type="checkbox"/>	<input type="checkbox"/>	<input type="checkbox"/>	<input type="checkbox"/>	<input type="checkbox"/>	<input type="checkbox"/>	<input type="checkbox"/>	<input type="checkbox"/>	<input type="checkbox"/>	<input type="checkbox"/>	<input type="checkbox"/>	<input type="checkbox"/>	<input type="checkbox"/>	<input type="checkbox"/>	<input type="checkbox"/>	<input type="checkbox"/>	<input type="checkbox"/>	<input type="checkbox"/>	<input type="checkbox"/>	<input type="checkbox"/>	<input type="checkbox"/>
4 (Network)	<input type="checkbox"/>	<input type="checkbox"/>	<input type="checkbox"/>	<input checked="" type="checkbox"/>	<input type="checkbox"/>	<input type="checkbox"/>	<input type="checkbox"/>	<input type="checkbox"/>	<input type="checkbox"/>	<input type="checkbox"/>	<input type="checkbox"/>	<input type="checkbox"/>	<input type="checkbox"/>	<input type="checkbox"/>	<input type="checkbox"/>	<input type="checkbox"/>	<input type="checkbox"/>	<input type="checkbox"/>	<input type="checkbox"/>	<input type="checkbox"/>	<input type="checkbox"/>	<input type="checkbox"/>	<input type="checkbox"/>	<input type="checkbox"/>
5 (Guest)	<input type="checkbox"/>	<input type="checkbox"/>	<input type="checkbox"/>	<input type="checkbox"/>	<input checked="" type="checkbox"/>	<input type="checkbox"/>	<input type="checkbox"/>	<input type="checkbox"/>	<input type="checkbox"/>	<input type="checkbox"/>	<input type="checkbox"/>	<input type="checkbox"/>	<input type="checkbox"/>	<input type="checkbox"/>	<input type="checkbox"/>	<input type="checkbox"/>	<input type="checkbox"/>	<input type="checkbox"/>	<input type="checkbox"/>	<input type="checkbox"/>	<input type="checkbox"/>	<input type="checkbox"/>	<input type="checkbox"/>	<input type="checkbox"/>
6	<input type="checkbox"/>	<input type="checkbox"/>	<input type="checkbox"/>	<input type="checkbox"/>	<input type="checkbox"/>	<input checked="" type="checkbox"/>	<input type="checkbox"/>	<input type="checkbox"/>	<input type="checkbox"/>	<input type="checkbox"/>	<input type="checkbox"/>	<input type="checkbox"/>	<input type="checkbox"/>	<input type="checkbox"/>	<input type="checkbox"/>	<input type="checkbox"/>	<input type="checkbox"/>	<input type="checkbox"/>	<input type="checkbox"/>	<input type="checkbox"/>	<input type="checkbox"/>	<input type="checkbox"/>	<input type="checkbox"/>	<input type="checkbox"/>
7	<input type="checkbox"/>	<input type="checkbox"/>	<input type="checkbox"/>	<input type="checkbox"/>	<input type="checkbox"/>	<input type="checkbox"/>	<input checked="" type="checkbox"/>	<input type="checkbox"/>	<input type="checkbox"/>	<input type="checkbox"/>	<input type="checkbox"/>	<input type="checkbox"/>	<input type="checkbox"/>	<input type="checkbox"/>	<input type="checkbox"/>	<input type="checkbox"/>	<input type="checkbox"/>	<input type="checkbox"/>	<input type="checkbox"/>	<input type="checkbox"/>	<input type="checkbox"/>	<input type="checkbox"/>	<input type="checkbox"/>	<input type="checkbox"/>
8	<input type="checkbox"/>	<input type="checkbox"/>	<input type="checkbox"/>	<input type="checkbox"/>	<input type="checkbox"/>	<input type="checkbox"/>	<input checked="" type="checkbox"/>	<input type="checkbox"/>	<input type="checkbox"/>	<input type="checkbox"/>	<input type="checkbox"/>	<input type="checkbox"/>	<input type="checkbox"/>	<input type="checkbox"/>	<input type="checkbox"/>	<input type="checkbox"/>	<input type="checkbox"/>	<input type="checkbox"/>	<input type="checkbox"/>	<input type="checkbox"/>	<input type="checkbox"/>	<input type="checkbox"/>	<input type="checkbox"/>	<input type="checkbox"/>

Fig. 3-130 Set up Port Policies

Finished !

The ACL configuration wizard is finished, and the new configuration is ready for use.

Click Finish to get more information.
Click Wizard Again to start the wizard again.

Wizard Again

Finish

Fig. 3-131 Set up Port Policies

ACL Ports Configuration

Port #	Policy ID	Action	Rate Limiter ID	Port Copy	Counter
1	1	Permit	Disabled	Disabled	5463
2	2	Permit	Disabled	Disabled	0
3	3	Permit	Disabled	Disabled	0
4	4	Permit	Disabled	Disabled	0
5	5	Permit	Disabled	Disabled	0
6	6	Permit	Disabled	Disabled	0
7	7	Permit	Disabled	Disabled	0
8	8	Permit	Disabled	Disabled	0
9	1	Permit	Disabled	Disabled	0
10	1	Permit	Disabled	Disabled	0
11	1	Permit	Disabled	Disabled	0
12	1	Permit	Disabled	Disabled	0
13	1	Permit	Disabled	Disabled	0
14	1	Permit	Disabled	Disabled	0
15	1	Permit	Disabled	Disabled	0

Fig. 3-132 **Set up Port Policies** Finish

Welcome to the ACL Configuration Wizard!

Please select an action:

Set up Policy Rules

Set up the default policy rules for Client ports, Server ports, Network ports, and Guest ports.

Set up Port Policies

Group ports into several types according to different ACL policies.

Set up Typical Network Application Rules

Set up the specific ACL for different typical network application access control.

Set up Source MAC and Source IP Binding

Strictly control the network traffic by only allowing incoming frames that match the source MAC and source IP on specific ports.

To continue, click Next.

Next >

Fig. 3-133 **Set up Typical Network Application Rules**

Set up Typical Network Application Rules

Set up the specific ACL for different typical network application access control by selecting the network application type for your rule:

o Common Servers

DHCP DNS FTP HTTP IMAP NFS POP3 SAMBA SMTP TELNET TFTP

o Instant Messaging

Google Talk MSN Messenger Yahoo Messenger

o User Definition

Ethernet Type UDP Port **Specific** TCP Port **Specific**

o Others

HTTPS ICMP Multicast IP Stream NetBIOS Ping Request Ping Reply SNMP SNMP Traps

Fig. 3-134 **Set up Typical Network Application Rules**

Set up Typical Network Application Rules

According to your decision on the previous page, this wizard will create specific ACEs (Access Control Entries) automatically.

First select the ingress port for these ACEs, and then select the action and rate limiter ID. Different parameter options are displayed depending on your selections.

Ingress Port	Any <input type="button" value="v"/>
Action	Deny <input type="button" value="v"/>
Rate Limiter ID	Disabled <input type="button" value="v"/>

Fig. 3-135 **Set up Typical Network Application Rules**

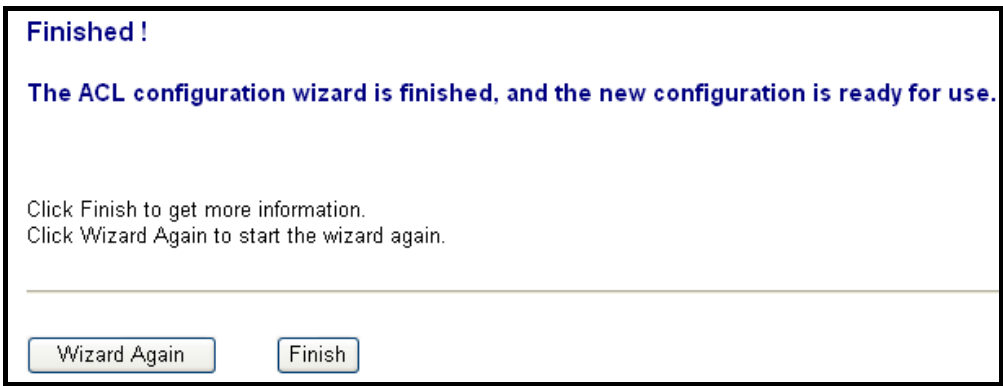

Fig. 3-136 Set up Typical Network Application Rules

Ingress Port	Frame Type	Action	Rate Limiter	Port Copy	Counters
Any	IPv4/DHCP Client (In)	Deny	Any	Disabled	0
Any	IPv4/DHCP Client (Out)	Deny	Any	Disabled	0
Any	IPv4/Google Talk (In)	Deny	Any	Disabled	0
Any	IPv4/Google Talk (Out)	Deny	Any	Disabled	0
Any	EType	Deny	Any	Disabled	0
Any	IPv4/HTTPS (In)	Deny	Any	Disabled	0
Any	IPv4/HTTPS (Out)	Deny	Any	Disabled	0

Fig. 3-137 Set up Typical Network Application Rules Finish

Parameter description:

Common Server:

DHCP / DNS / FTP / HTTP / IMAP / NFS / POP3 / SAMBA / SMTP / TELNET / TFTP

Instant Messaging:

Google Talk / MSN Messenger / Yahoo Messenger

User Definition:

Ethernet Type / UDP Port / TCP Port

Others:

TCP Port / ICMP / Multicast IP Stream / NetBIOS / Ping Request / Ping Reply / SNMP / SNMP Traps

Ingress Port:

Any / Policy1-8 / Port1-24

Action:

Permit / Deny

Rate Limiter ID:

Disabled / 1-16

Welcome to the ACL Configuration Wizard!

Please select an action:

- Set up Policy Rules**
Set up the default policy rules for Client ports, Server ports, Network ports, and Guest ports.
- Set up Port Policies**
Group ports into several types according to different ACL policies.
- Set up Typical Network Application Rules**
Set up the specific ACL for different typical network application access control.
- Set up Source MAC and Source IP Binding**
Strictly control the network traffic by only allowing incoming frames that match the source MAC and source IP on specific ports.

To continue, click Next.

Fig. 3-138 **Set up Source MAC and Source IP Binding**

Set up Source MAC and Source IP Binding

Strictly control the network traffic by only allowing incoming frames that match the source MAC and source IP on specific port.

Port #	Binding Enabled	Source MAC Address	Source IP Address
1	<input type="checkbox"/>		
2	<input checked="" type="checkbox"/>	<input type="text" value="00-00-00-00-00-10"/>	<input type="text" value="192.168.1.1"/>
3	<input type="checkbox"/>		
4	<input type="checkbox"/>		
5	<input type="checkbox"/>		
6	<input type="checkbox"/>		
7	<input type="checkbox"/>		
8	<input type="checkbox"/>		
9	<input type="checkbox"/>		
10	<input type="checkbox"/>		
11	<input type="checkbox"/>		

Fig. 3-139 **Set up Source MAC and Source IP Binding**

Finished!

The ACL configuration wizard is finished, and the new configuration is ready for use.

Click Finish to get more information.
Click Wizard Again to start the wizard again.

Wizard Again

Finish

Fig. 3-140 Set up Source MAC and Source IP Binding

Access Control List Configuration

Auto-refresh Refresh Clear

Ingress Port	Frame Type	Action	Rate Limiter	Port Copy	Counters	
Port 2	SMAC/SIP Binding - 192.168.1.1	Permit	Any	Disabled	0	
Port 2	SMAC/SIP Binding - 00-00-00-00-00-10	Permit	Any	Disabled	0	
Any	Any	Permit	Any	Disabled	258	

Fig. 3-141 Set up Source MAC and Source IP Binding Finish

Parameter description:

Port #:

1-24

Binding Enabled:

Use the switch ACL function to support IP/MAC Binding function, the maximum is up to 128 entries.

Source MAC Address: xx-xx-xx-xx-xx-xx

For example: 00-40-c7-00-00-01

Source IP Address: xxx.xxx.xxx.xxx

For example: 192.168.1.100

3-9. IP MAC Binding

The IP network layer uses a four-byte address. The Ethernet link layer uses a six-byte MAC address. Binding these two address types together allows the transmission of data between the layers. The primary purpose of IP-MAC binding is to restrict the access to a switch to a number of authorized users. Only the authorized client can access the Switch's port by checking the pair of IP-MAC Addresses and port number with the pre-configured database. If an unauthorized user tries to access an IP-MAC binding enabled port, the system will block the access by dropping its packet.

3-9-1. IP MAC Binding Configuration

Function name:

IP MAC Binding Configuration

Function description:

The switch has IP-MAC Binding table. The maximum number of IP-MAC binding table is 1024 entries. The creation of authorized users can be manually. The function is global, this means a user can enable or disable the function for all ports on the switch.

IP MAC Binding Configuration

State	Disabled ▾							
Trust Port	1. <input type="checkbox"/>	2. <input type="checkbox"/>	3. <input type="checkbox"/>	4. <input type="checkbox"/>	5. <input type="checkbox"/>	6. <input type="checkbox"/>	7. <input type="checkbox"/>	8. <input type="checkbox"/>
	9. <input type="checkbox"/>	10. <input type="checkbox"/>	11. <input type="checkbox"/>	12. <input type="checkbox"/>	13. <input type="checkbox"/>	14. <input type="checkbox"/>	15. <input type="checkbox"/>	16. <input type="checkbox"/>
	17. <input type="checkbox"/>	18. <input type="checkbox"/>	19. <input type="checkbox"/>	20. <input type="checkbox"/>	21. <input type="checkbox"/>	22. <input type="checkbox"/>	23. <input type="checkbox"/>	24. <input type="checkbox"/>

MAC	IP	Port No	VID
<input type="text"/> - <input type="text"/> - <input type="text"/> - <input type="text"/> - <input type="text"/> - <input type="text"/>	<input type="text"/>	1 ▾	<input type="text"/>

No	MAC	IP	Port	VID
----	-----	----	------	-----

Fig. 3-142 IP MAC Binding Configuration

Parameters description:

State:

Disabled / Enabled

Trust Port:

To evoke the port which you want to enable the IP MAC binding service..

MAC:

Six-byte MAC Address: xx-xx-xx-xx-xx-xx

For example: 00-40-c7-00-00-01

IP:

Four-byte IP Address: xxx.xxx.xxx.xxx

For example: 192.168.1.100

Port No:

Port no.: 1-24

VID:

VLAN ID: 1-4094

Add:

Input MAC, IP, Port and VID, then click on <Add> to create a new entry into the IP MAC Binding table

Delete:

Select one of entry from the table, then click on <Delete> to delete this entry.

3-9-2. IP MAC Binding Dynamic Entry

Function name:

IP MAC Binding Dynamic Entry

Function description:

It to display the IP MAC Binding dynamic Entry information.

IP MAC Binding Dynamic Entry

No	MAC	IP	Port	VID
----	-----	----	------	-----

Delete

Fig. 3-142-1 IP MAC Binding Dynamic Entry

Parameters description:

No:

The index to display the IP MAC Binding Dynamic Entry

MAC:

T Six-byte MAC Address: xx-xx-xx-xx-xx-xx

For example: 00-40-c7-00-00-01

IP:

Four-byte IP Address: xxx.xxx.xxx.xxx

For example: 192.168.1.100

Port No:

Port no.: 1-24

VID:

VLAN ID: 1-4094

3-10. 802.1X Configuration

802.1X port-based network access control provides a method to restrict users to access network resources via authenticating user's information. This restricts users from gaining access to the network resources through a 802.1X-enabled port without authentication. If a user wishes to touch the network through a port under 802.1X control, he (she) must firstly input his (her) account name for authentication and waits for gaining authorization before sending or receiving any packets from a 802.1X-enabled port.

Before the devices or end stations can access the network resources through the ports under 802.1X control, the devices or end stations connected to a controlled port send the authentication request to the authenticator, the authenticator pass the request to the authentication server to authenticate and verify, and the server tell the authenticator if the request get the grant of authorization for the ports.

According to IEEE802.1X, there are three components implemented. They are Authenticator, Supplicant and Authentication server shown in Fig. 3-53.

Supplicant:

It is an entity being authenticated by an authenticator. It is used to communicate with the Authenticator **PAE (Port Access Entity)** by exchanging the authentication message when the Authenticator PAE request to it.

Authenticator:

An entity facilitates the authentication of the supplicant entity. It controls the state of the port, authorized or unauthorized, according to the result of authentication message exchanged between it and a supplicant PAE.

The authenticator may request the supplicant to re-authenticate itself at a configured time period. Once start re-authenticating the supplicant, the controlled port keeps in the authorized state until re-authentication fails.

A port acting as an authenticator is thought to be two logical ports, a controlled port and an uncontrolled port. A controlled port can only pass the packets when the authenticator PAE is authorized, and otherwise, an uncontrolled port will unconditionally pass the packets with PAE group MAC address, which has the value of 01-80-c2-00-00-03 and will not be forwarded by MAC bridge, at any time.

Authentication server:

A device provides authentication service, through EAP, to an authenticator by using authentication credentials supplied by the supplicant to determine if the supplicant is authorized to access the network resource.

The overview of operation flow for the **Fig. 3-53** is quite simple. When Supplicant PAE issues a request to Authenticator PAE, Authenticator and Supplicant exchanges authentication message. Then, Authenticator passes the request to RADIUS server to verify. Finally, RADIUS server replies if the request is granted or denied.

While in the authentication process, the message packets, encapsulated by **Extensible Authentication Protocol over LAN (EAPOL)**, are exchanged between an authenticator PAE and a supplicant PAE. The Authenticator exchanges the message to authentication server using EAP encapsulation. Before successfully authenticating, the supplicant can only touch the authenticator to perform authentication message exchange or access the network from the uncontrolled port.

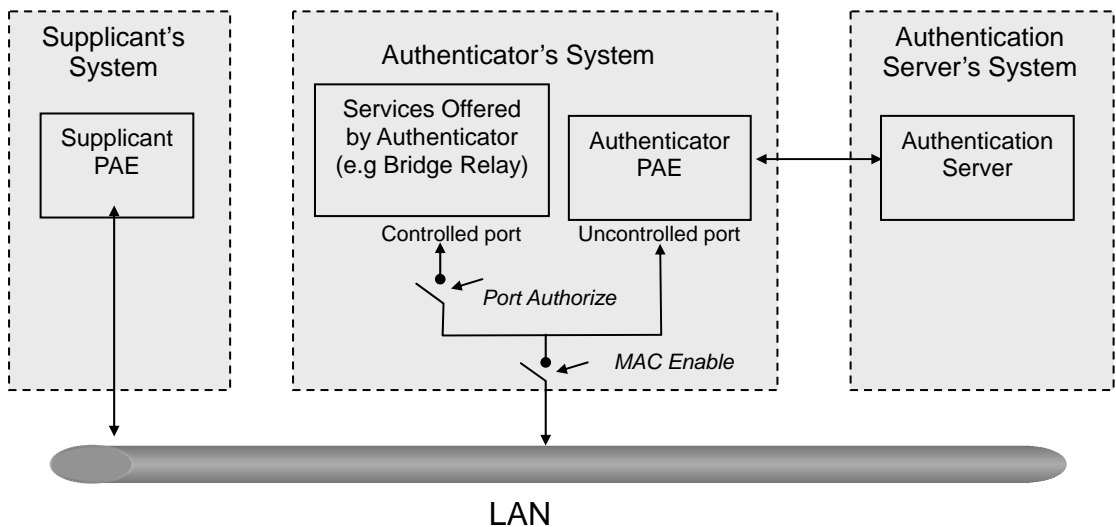

Fig. 3-53

In the **Fig. 3-54**, this is the typical configuration, a single supplicant, an authenticator and an authentication server. B and C is in the internal network, D is Authentication server running RADIUS, switch at the central location acts Authenticator connecting to PC A and A is a PC outside the controlled port, running Supplicant PAE. In this case, PC A wants to access the services on device B and C, first, it must exchange the authentication message with the authenticator on the port it connected via EAPOL packet. The authenticator transfers the supplicant's credentials to Authentication server for verification. If success, the authentication server will notice the authenticator the grant. PC A, then, is allowed to access B and C via the switch. If there are two switches directly connected together instead of single one, for the link connecting two switches, it may have to act two port roles at the end of the link: authenticator and supplicant, because the traffic is bi-directional.

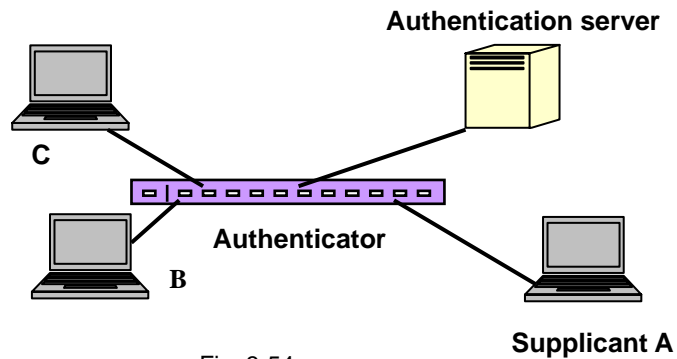

Fig. 3-54

The Fig. 3-55 shows the procedure of 802.1X authentication. There are steps for the login based on 802.1X port access control management. The protocol used in the right side is EAPOL and the left side is EAP.

1. At the initial stage, the supplicant A is unauthenticated and a port on switch acting as an authenticator is in unauthorized state. So the access is blocked in this stage.
2. Initiating a session. Either authenticator or supplicant can initiate the message exchange. If supplicant initiates the process, it sends EAPOL-start packet to the authenticator PAE and authenticator will immediately respond EAP-Request/Identity packet.
3. The authenticator always periodically sends EAP-Request/Identity to the supplicant for requesting the identity it wants to be authenticated.
4. If the authenticator doesn't send EAP-Request/Identity, the supplicant will initiate EAPOL-Start the process by sending to the authenticator.
5. And next, the Supplicant replies an EAP-Response/Identity to the authenticator. The authenticator will embed the user ID into Radius-Access-Request command and send it to the authentication server for confirming its identity.
6. After receiving the Radius-Access-Request, the authentication server sends Radius-Access-Challenge to the supplicant for asking for inputting user password via the authenticator PAE.
7. The supplicant will convert user password into the credential information, perhaps, in MD5 format and replies an EAP-Response with this credential information as well as the specified authentication algorithm (MD5 or OTP) to Authentication server via the authenticator PAE. As per the value of the type field in message PDU, the authentication server knows which algorithm should be applied to authenticate the credential information, EAP-MD5 (Message Digest 5) or EAP-OTP (One Time Password) or other else algorithm.

8. If user ID and password is correct, the authentication server will send a Radius-Access-Accept to the authenticator. If not correct, the authentication server will send a Radius-Access-Reject.
9. When the authenticator PAE receives a Radius-Access-Accept, it will send an EAP-Success to the supplicant. At this time, the supplicant is authorized and the port connected to the supplicant and under 802.1X control is in the authorized state. The supplicant and other devices connected to this port can access the network. If the authenticator receives a Radius-Access-Reject, it will send an EAP-Failure to the supplicant. This means the supplicant is failed to authenticate. The port it connected is in the unauthorized state, the supplicant and the devices connected to this port won't be allowed to access the network.
10. When the supplicant issue an EAP-Logoff message to Authentication server, the port you are using is set to be unauthorized.

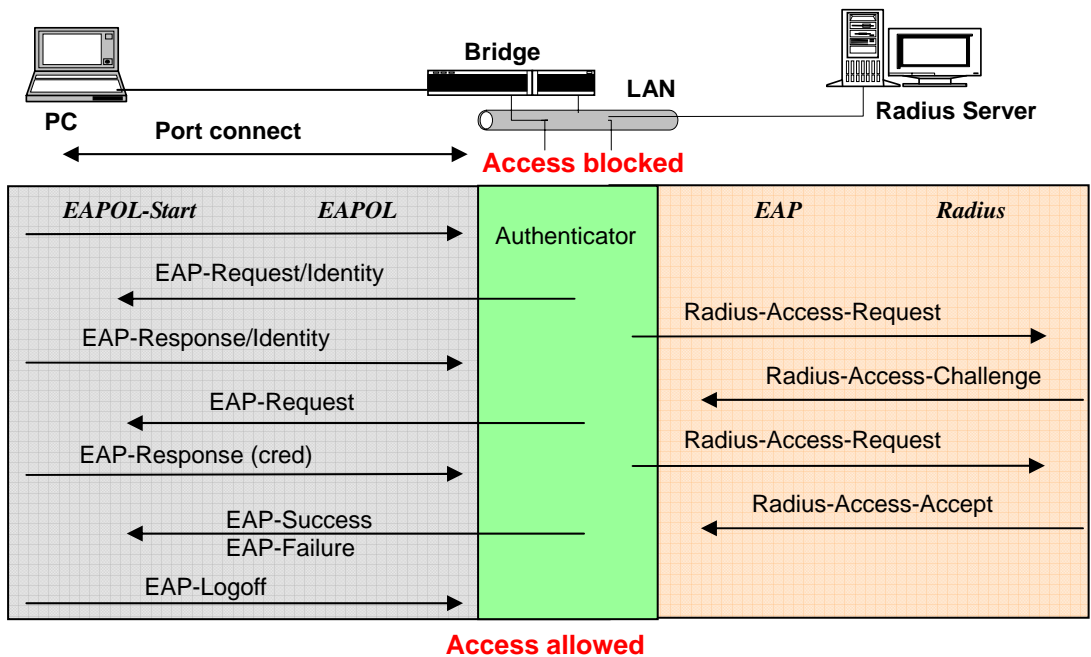

Fig. 3-55

Only MultiHost 802.1X is the type of authentication supported in the switch. In this mode, for the devices connected to this port, once a supplicant is authorized, the devices connected to this port can access the network resource through this port.

802.1X Port-based Network Access Control function supported by the switch is little bit complex, for it just support basic Multihost mode, which can distinguish the device's MAC address and its VID. The following table is the summary of the combination of the authentication status and the port status versus the status of port mode, set in 802.1X Port mode, port control state, set in 802.1X port setting. Here Entry Authorized means MAC entry is authorized.

Port Mode	Port Control	Authentication	Port Status
Disable	Don't Care	Don't Care	Port Uncontrolled
Multihost	Auto	Successful	Port Authorized
Multihost	Auto	Failure	Port Unauthorized
Multihost	ForceUnauthorized	Don't Care	Port Unauthorized
Multihost	ForceAuthorized	Don't Care	Port Authorized

Table 3-3

3-10-1.Server

Function name:

802.1X Server Configuration

Function description:

This function is used to configure the global parameters for RADIUS authentication in 802.1X port security application.

802.1X Server Configuration

Authentication Server	
Server IP Address 1	<input type="text" value="192.168.1.1"/>
UDP Port	<input type="text" value="1812"/>
Server IP Address 2	<input type="text" value="192.168.1.1"/>
UDP Port	<input type="text" value="1812"/>
Secret Key	<input type="text" value="Radius"/>

Accounting Server	
Server IP Address 1	<input type="text" value="192.168.1.1"/>
UDP Port	<input type="text" value="1813"/>
Server IP Address 2	<input type="text" value="192.168.1.1"/>
UDP Port	<input type="text" value="1813"/>
Secret Key	<input type="text" value="Radius"/>

Fig. 3-143 802.1X Server Configuration

Parameter description:

Authentication Server

Server IP Server:

Server IP address for authentication.

Default: **192.168.1.1**

UDP Port:

Default port number is 1812.

Secret Key:

The secret key between authentication server and authenticator. It is a string with the length 1 – 31 characters. The character string may contain upper case, lower case and 0-9. It is character sense. It is not allowed for putting a blank between any two characters.

Default: **Radius**

Accounting Server**Server IP Server:**

Server IP address for authentication.

Default: **192.168.1.1**

UDP Port:

Default port number is 1812.

Secret Key:

The secret key between authentication server and authenticator. It is a string with the length 1 – 31 characters. The character string may contain upper case, lower case and 0-9. It is character sense. It is not allowed for putting a blank between any two characters.

Default: **Radius**

3-10-2.Port Configuration

Function name:

802.1X Port Configuration

Function description:

This function is used to configure the parameters for each port in 802.1X port security application. Refer to the following parameters description for details.

802.1X Port Configuration		
Port	Port 1	
Mode	Clientless	
Port Control	Disabled	
reAuthMax	Advanced	(1-10)
txPeriod	30	(1-65535 sec)
quietPeriod	60	(0-65535 sec)
reAuthEnabled	ON	
reAuthPeriod	120	(1-65535 sec)
maxReq	2	(1-10)
suppTimeout	30	(1-255 sec)
serverTimeout	30	(1-255 sec)

Save

Fig. 3-144 802.1X Port Configuration

Parameter description:

Port:

It is the port number to be selected for configuring its associated 802.1X parameters which are Port control, reAuthMax, txPeriod, Quiet Period, reAuthEnabled, reAuthPeriod, max. Request, suppTimeout, serverTimeout and Controlled direction.

Mode:

Range: **Disable / Normal / Advance / Clientless**

Disable:

Disable IEEE 802.1X for this port.

Normal:

All clients under this port will be authorized when one of the client do 802.1X authentication successfully.

Advanced:

Each clients under this port have to do 802.1X authentication by himself.

Clientless:

The clients don't need to install 802.1X client function, that means the client PC (for example WINDOW XP) does not need to enable 802.1X client function also can do 802.1X authentication. But the network maintainer need to configure the Radius server using each client's MAC address for Radius account ID and password.

Port Control:

This is used to set the operation mode of authorization. There are three type of operation mode supported, ForceUnauthorized, ForceAuthorized, Auto.

- **ForceUnauthorized:**

The controlled port is forced to hold in the unauthorized state.

- **ForceAuthorized:**

The controlled port is forced to hold in the authorized state.

- **Auto:**

The controlled port is set to be in authorized state or unauthorized state depends on the result of the authentication exchange between the authentication server and the supplicant.

Default: **Auto**

reAuthMax(1-10):

The number of authentication attempt that is permitted before the port becomes unauthorized.

Default: **2**

txPeriod(1-65535 s):

A time period to transmitted EAPOL PDU between the authenticator and the supplicant.

Default: **30**

Quiet Period(0-65535 s):

A period of time during which we will not attempt to access the supplicant.

Deafult: **60 seconds**

reAuthEnabled:

Choose whether regular authentication will take place in this port.

Default: **ON**

reAuthPeriod(1-65535 s):

A non-zero number seconds between the periodic re-authentication of the supplicant.

Default: **3600**

max. Request(1-10):

The maximum of number times that the authenticator will retransmit an EAP Request to the supplicant before it times out the authentication session. The valid range: 1 – 10.

Default: **2 times**

suppTimeout(1-65535 s):

A timeout condition in the exchange between the authenticator and the supplicant. The valid range: 1 –65535.

Default: **30 seconds.**

serverTimeout(1-65535 s):

A timeout condition in the exchange between the authenticator and the authentication server. The valid range: 1 –65535.

Default: **30 seconds**

3-10-3.Status

Function name:

802.1X Status

Function description:

Show the each port IEEE 802.1X authentication current operating mode and status.

Parameter description:

Port:

Port number: 1-24

Mode:

Show this port IEEE 802.1X operating mode: There are four modes Disable, Normal, Advance and Clientless

Status:

Show this port IEEE 802.1X security current status: Authorized or Unauthorized



The screenshot shows a web interface titled "802.1X Status" with a "Refresh" button in the top right corner. Below the title is a table with three columns: "Port", "Mode", and "Status". The table lists 13 ports, all with "Disable" mode and "-" status.

Port	Mode	Status
1	Disable	-
2	Disable	-
3	Disable	-
4	Disable	-
5	Disable	-
6	Disable	-
7	Disable	-
8	Disable	-
9	Disable	-
10	Disable	-
11	Disable	-
12	Disable	-
13	Disable	-

Fig. 3-145 802.1X Status

3-10-4. Statistics

Function name:

802.1X Port Statistics Port1

Function description:

Show the IEEE 802.1X authentication related counters for manager monitoring authenticator status.

Parameter description:

Port:

Port Number: 1-24

Auto - refresh:

Refresh the authenticator counters in the web UI automatically

Refresh:

Click on the <Refresh> to update the authenticator counters in the web UI

Clear:

Click on the <Clear> to clear all authenticator counters in the web UI

802.1X Port Statistics Port 1	
Port 1 <input type="checkbox"/> Auto-refresh <input type="button" value="Refresh"/> <input type="button" value="Clear"/>	
Authenticator Counters	
authEntersConnecting	0
authEapLogoffsWhileConnecting	0
authEntersAuthenticating	0
authAuthSuccessesWhileAuthenticating	0
authAuthTimeoutsWhileAuthenticating	0
authAuthFailWhileAuthenticating	0
authAuthEapStartsWhileAuthenticating	0
authAuthEapLogoffWhileAuthenticating	0
authAuthReauthsWhileAuthenticated	0
authAuthEapStartsWhileAuthenticated	0
authAuthEapLogoffWhileAuthenticated	0
Backend Authenticator Counters	
backendResponses	0
backendAccessChallenges	0
backendOtherRequestsToSupplicant	0
backendAuthSuccesses	0
backendAuthFails	0

Fig. 3-146 802.1X Port Statistics

3-11. Trunking Configuration

The Port Trunking Configuration is used to configure the settings of Link Aggregation. You can bundle more than one port with the same speed, full duplex and the same MAC to be a single logical port, thus the logical port aggregates the bandwidth of these ports. This means you can apply your current Ethernet equipments to build the bandwidth aggregation. For example, if there are three Fast Ethernet ports aggregated in a logical port, then this logical port has bandwidth three times as high as a single Fast Ethernet port has.

The switch supports two kinds of port trunking methods:

LACP:

Ports using **Link Aggregation Control Protocol (according to IEEE 802.3ad specification)** as their trunking method can choose their unique LACP GroupID (1~8) to form a logic “trunked port”. The benefit of using LACP is that a port makes an agreement with its peer port before it becomes a ready member of a “trunk group” (also called aggregator). LACP is safer than the other trunking method - static trunk.

The switch LACP does not support the followings:

- **Link Aggregation across switches**
- **Aggregation with non-IEEE 802.3 MAC link**
- **Operating in half-duplex mode**
- **Aggregate the ports with different data rates**

Static Trunk:

Ports using Static Trunk as their trunk method can choose their unique **Static GroupID (also 1~8, this Static groupID can be the same with another LACP groupID)** to form a logic “trunked port”. The benefit of using Static Trunk method is that a port can immediately become a member of a trunk group without any handshaking with its peer port. This is also a disadvantage because the peer ports of your static trunk group may not know that they should be aggregate together to form a “logic trunked port”. Using Static Trunk on both end of a link is strongly recommended. Please also note that low speed links will stay in “not ready” state when using static trunk to aggregate with high speed links.

As to system restrictions about the port aggregation function on the switch, In the management point of view, the switch supports **maximum 8 trunk groups for LACP and additional 8 trunk groups for Static Trunk**. But in the system capability view, only 8 “real trunked” groups are supported. An LACP trunk group with more than one ready member-ports is a “real trunked” group. An LACP trunk group with only one or less than one ready member-ports is not a “real trunked” group. Any Static trunk group is a “real trunked” group.

Per Trunking Group supports a maximum of 12 ready member-ports. Please note that some decisions will automatically be made by the system while you are configuring your trunking ports. Some configuration examples are listed below:

- a) 12 ports have already used Static Trunk Group ID 1, the 13th port willing to use the same Static Trunk Group ID will be automatically set to use the “None” trunking method and its Group ID will turn to 0. This means the port won’t aggregate with other ports.
- b) 14 ports all use LACP Trunk Group ID 1 at most 12 ports can aggregate together and transit into the ready state.
- c) A port using the “None” trunking method or Group ID 0 will be automatically set to use the “None” trunking method with Group ID 0.

3-11-1.Port

Function name:

Trunk Port Setting/Status

Function description:

Port setting/status is used to configure the trunk property of each and every port in the switch system.

Trunk Port Setting				Trunk Port Status	
Port	Method	Group	Active LACP	Aggtr	Status
1	None ▾	0 ▾	Active ▾	1	Ready
2	None ▾	0 ▾	Active ▾	2	---
3	None ▾	0 ▾	Active ▾	3	---
4	None ▾	0 ▾	Active ▾	4	---
5	None ▾	0 ▾	Active ▾	5	---
6	None ▾	0 ▾	Active ▾	6	---
7	None ▾	0 ▾	Active ▾	7	---
8	None ▾	0 ▾	Active ▾	8	---
9	None ▾	0 ▾	Active ▾	9	---
10	None ▾	0 ▾	Active ▾	10	---
11	None ▾	0 ▾	Active ▾	11	---
12	None ▾	0 ▾	Active ▾	12	---
13	None ▾	0 ▾	Active ▾	13	---
14	None ▾	0 ▾	Active ▾	14	---
15	None ▾	0 ▾	Active ▾	15	---

Fig.3-147 Trunk Port Setting

Parameter description:

Port:

Port Number: 1-24

Method:

This determines the method a port uses to aggregate with other ports.

None:

A port does not want to aggregate with any other port should choose this default setting.

LACP:

A port use LACP as its trunking method to get aggregated with other ports also using LACP.

Static:

A port use Static Trunk as its trunking method to get aggregated with other ports also using Static Trunk.

Group:

Ports choosing the same trunking method other than “None” must be assigned a unique Group number (*i.e. Group ID, valid value is from 1 to 8*) in order to declare that they wish to aggregate with each other.

Active LACP:

This field is only referenced when a port’s trunking method is LACP.

Active:

An Active LACP port begins to send LACPDU to its link partner right after the LACP protocol entity started to take control of this port.

Passive:

A Passive LACP port will not actively send LACPDU out before it receives an LACPDU from its link partner.

Aggtr:

Aggtr is an abbreviation of “aggregator”. Every port is also an aggregator, and its own aggregator ID is the same as its own Port No. We can regard an aggregator as a representative of a trunking group. Ports with same Group ID and using same trunking method will have the opportunity to aggregate to a particular aggregator port. This aggregator port is usually the port with the smallest Port No. within the trunking group.

Status:

This field represents the trunking status of a port which uses a trunking method other than “None”. It also represents the management link status of a port which uses the “None” trunking method. “--” means “not ready”

3-11-2 Aggregator View

Function name:

Aggregator View

Function description:

To display the current port trunking information from the aggregator point of view.

Aggregator	Method	Member Ports	Ready Ports
1	None	1	1
2	None	2	
3	None	3	
4	None	4	
5	None	5	
6	None	6	
7	None	7	
8	None	8	
9	None	9	
10	None	10	
11	None	11	
12	None	12	
13	None	13	
14	None	14	
15	None	15	
16	None	16	

Fig.3-148 Aggregator View

Parameter description:

Aggregator:

It shows the aggregator ID (from 1 to 24) of every port. In fact, every port is also an aggregator, and its own aggregator ID is the same as its own Port No..

Method:

Show the method a port uses to aggregate with other ports.

Member Ports:

Show all member ports of an aggregator (port).

Ready Ports:

Show only the ready member ports within an aggregator (port).

3-11-3 ACP System Priority

Function name:

LACP System Priority

Function description:

It is used to set the priority part of the LACP system ID. LACP will only aggregate together the ports whose peer link partners are all on a single system. Each system supports LACP will be assigned a globally unique System Identifier for this purpose. A system ID is a 64-bit field comprising a 48-bit MAC Address and 16-bit priority value. The System Priority can be set by the user. Its range is from 1 to 65535. Default: 32768

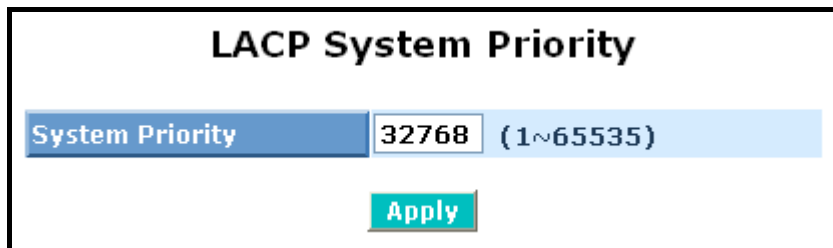

LACP System Priority

System Priority (1~65535)

Apply

Fig. 3-149 LACP System Priority

Parameter description:

System Priority:

Show the System Priority part of a system ID.(1-65535)

3-12 STP Configuration

The **Spanning Tree Protocol (STP)** is a standardized method (**IEEE 802.1D**) for avoiding loops in switched networks. When STP is enabled, ensure that only one path is active between any two nodes on the network at a time. User can enable Spanning Tree Protocol on switch's web management and then set up other advanced items. We recommend that you enable STP on all switches to ensure a single active path on the network.

3-12-1. Status

Function name:

STP Status

Function description:

In the Spanning Tree Status, user can read 12 parameters to know STP current status. The 12 parameters' description is listed in the following table.

STP Status	
STP State	Disabled
Bridge ID	00:40:C7:01:02:33
Bridge Priority	32768
Designated Root	00:40:C7:01:02:33
Designated Priority	32768
Root Port	0
Root Path Cost	0
Current Max. Age(sec)	20
Current Forward Delay(sec)	15
Hello Time(sec)	2
STP Topology Change Count	0
Time Since Last Topology Change(sec)	0

Fig. 3-150 STP Status

Parameter description:

STP State:

Show the current STP Enabled / Disabled status. **Default is "Disabled"**.

Bridge ID:

Show switch's bridge ID which stands for the MAC address of this switch.

Bridge Priority:

Show this switch's current bridge priority setting. **Default is 32768**.

Designated Root:

Show root bridge ID of this network segment. If this switch is a root bridge, the "Designated Root" will show this switch's bridge ID.

Designated Priority:

Show the current root bridge priority.

Root Port:

Show port number connected to root bridge with the lowest path cost.

Root Path Cost:

Show the path cost between the root port and the designated port of the root bridge.

Current Max. Age:

Show the current root bridge maximum age time. Maximum age time is used to monitor if STP topology needs to change. When a bridge does not receive a hello message from root bridge until the maximum age time is counted down to 0, the bridge will treat the root bridge malfunctioned and issue a Topology Change Notification (TCN) BPDU to all other bridges.

All bridges in the LAN will re-learn and determine which the root bridge is. Maximum Age time is assigned by root bridge in unit of seconds. **Default is 20 seconds.**

Current Forward Delay:

Show the current root bridge forward delay time. The value of Forward Delay time is set by root. The Forward Delay time is defined as the time spent from Listening state moved to Learning state or from Learning state moved to Forwarding state of a port in bridge.

Hello Time:

Show the current hello time of the root bridge. Hello time is a time interval specified by root bridge, used to request all other bridges periodically sending hello message every "hello time" seconds to the bridge attached to its designated port.

STP Topology Change Count:

STP Topology Change Count expresses the time spent in unit of seconds since the beginning of the Spanning Tree Topology Change to the end of the STP convergence. Once the STP change is converged, the Topology Change count will be reset to 0. The figures showing in the screen may not be the exact time it spent but very close to, because the time is eclipsing.

Time Since Last Topology Change:

Time Since Last Topology Change is the accumulated time in unit of seconds the STP has been since the last STP Topology Change was made. When Topology Change is initiated again, this counter will be reset to 0. And it will also count again once STP topology Change is completed.

3-12-2. Configuration

The STP, Spanning Tree Protocol, actually includes RSTP. In the Spanning Tree Configuration, there are six parameters open for the user to configure as user's idea. Each parameter description is listed below.

Function name:

STP Configuration

Function description:

User can set the following Spanning Tree parameters to control STP function enable/disable, select mode **RSTP/STP** and affect STP state machine behavior to send BPDU in this switch. The default setting of Spanning Tree Protocol is "Disable".

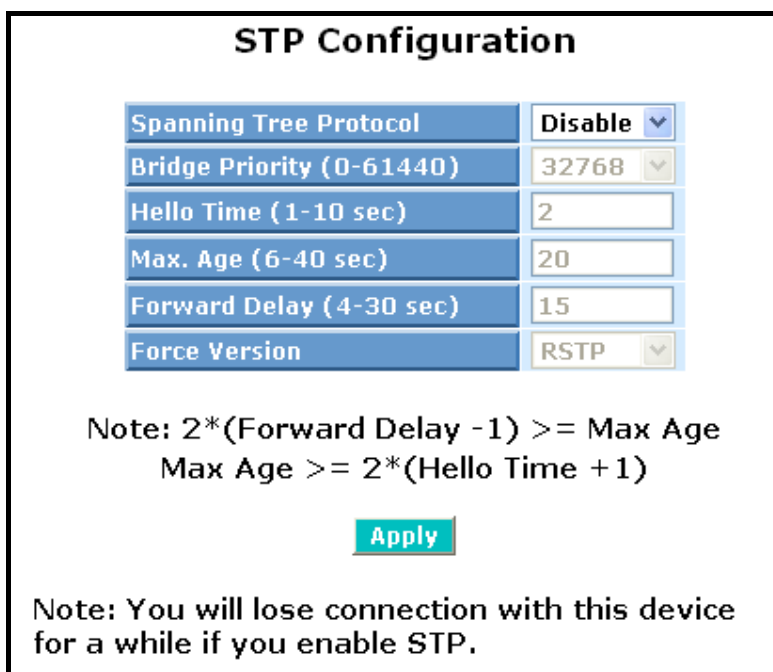

The screenshot shows a configuration window titled "STP Configuration". It contains a table of parameters with their current values and a note below. The parameters are:

Parameter	Value
Spanning Tree Protocol	Disable
Bridge Priority (0-61440)	32768
Hello Time (1-10 sec)	2
Max. Age (6-40 sec)	20
Forward Delay (4-30 sec)	15
Force Version	RSTP

Note: $2 * (\text{Forward Delay} - 1) \geq \text{Max Age}$
 $\text{Max Age} \geq 2 * (\text{Hello Time} + 1)$

Apply

Note: You will lose connection with this device for a while if you enable STP.

Fig. 3-151 STP Configuration

Parameter description:

Spanning Tree Protocol:

Set 802.1W Rapid STP function Enable / Disable. **Default is "Disable"**

Bridge Priority:

The lower the bridge priority is, the higher priority it has. Usually, the bridge with the highest bridge priority is the root. If you want to have the GEFXL2P-SW24 as root bridge, you can set this value lower than that of bridge in the LAN. **The valid value is 0 ~ 61440. The default is 32768.**

Hello Time:

Hello Time is used to determine the periodic time to send normal BPDU from designated ports among bridges. It decides how long a bridge should send this message to other bridge to tell I am alive. When the GEFXL2P-SW24 is the root bridge of the LAN, for example, all other bridges will use the hello time assigned by this switch to communicate with each other. The valid value is 1 ~ 10 in unit of second.

Default is 2 seconds.

Max. Age:

When the GEFXL2P-SW24 is the root bridge, the whole LAN will apply this figure set by this switch as their maximum age time. When a bridge received a BPDU originated from the root bridge and if the message age conveyed in the BPDU exceeds the Max. Age of the root bridge, the bridge will treat the root bridge malfunctioned and issue a Topology Change Notification (TCN) BPDU to all other bridges. All bridges in the LAN will re-calculate and determine who the root bridge is. ***The valid value of Max. Age is 6 ~ 40 seconds. Default is 20 seconds.***

Forward Delay:

You can set the root bridge forward delay time. This figure is set by root bridge only. The forward delay time is defined as the time spent from Listening state moved to Learning state and also from Learning state moved to Forwarding state of a port in bridge. The forward delay time contains two states, Listening state to Learning state and Learning state to Forwarding state. It assumes that forward delay time is 15 seconds, then total forward delay time will be 30 seconds. This has much to do with the STP convergent time which will be more than 30 seconds because some other factors.

The valid value is 4 ~ 30 seconds, default is 15 seconds.

Force Version:

Two options are offered for the user's choosing STP algorithm. One is RSTP and the other is STP. If STP is chosen, RSTP will run as a legacy STP. The switch supports RSTP (802.1w) which is backward compatible with STP (802.1d).

3-12-3. STP Port Configuration

Function name:

STP Port Setting

Function description:

In the STP Port Setting, one item selection and five parameters settings are offered for user's setup. User can disable and enable each port by selecting each Port Status item. User also can set "Path Cost" and "Priority" of each port by filling in the desired value and set "Admin Edge Port" and "Admin Point To Point" by selecting the desired item.

STP Port Configuration						
Port No	Port Status	Path Cost Status	Configured Path Cost	Priority	Admin Port Type	Admin Point To Point
1	FORWARDING	2000000	0	128	Normal	Auto
2	FORWARDING	2000000	0	128	Normal	Auto
3	FORWARDING	2000000	0	128	Normal	Auto
4	FORWARDING	2000000	0	128	Normal	Auto
5	FORWARDING	2000000	0	128	Normal	Auto
6	FORWARDING	2000000	0	128	Normal	Auto
7	FORWARDING	2000000	0	128	Normal	Auto
8	FORWARDING	2000000	0	128	Normal	Auto
9	FORWARDING	2000000	0	128	Normal	Auto
10	FORWARDING	2000000	0	128	Normal	Auto
11	FORWARDING	2000000	0	128	Normal	Auto
12	FORWARDING	2000000	0	128	Normal	Auto
13	FORWARDING	2000000	0	128	Normal	Auto
14	FORWARDING	2000000	0	128	Normal	Auto
15	FORWARDING	2000000	0	128	Normal	Auto
16	FORWARDING	2000000	0	128	Normal	Auto
17	FORWARDING	2000000	0	128	Normal	Auto
18	FORWARDING	2000000	0	128	Normal	Auto
19	FORWARDING	2000000	0	128	Normal	Auto
20	FORWARDING	2000000	0	128	Normal	Auto
21	FORWARDING	2000000	0	128	Normal	Auto
22	FORWARDING	2000000	0	128	Normal	Auto

Fig. 3-152 STP Port Configuration

Parameter description:

Port Status:

It displays the current state of a port. We cannot manually set it because it displays the status only. There are three possible states. (according to 802.1w specification)

- **DISCARDING state indicates that this port can neither forward packets nor contribute learning knowledge.**

Notice: Three other states (**Disable state**, **BLOCKING state** and **LISTENING state**) defined in the 802.1d specification are now all represented as DISCARDING state.

- **LEARNING state indicates this port can now contribute its learning knowledge but cannot forward packets still.**

- FORWARDING state indicates this port can both contribute its learning knowledge and forward packets normally.

Path Cost Status:

It is the contribution value of the path through this port to Root Bridge. STP algorithm determines a best path to Root Bridge by calculating the sum of path cost contributed by all ports on this path. A port with a smaller path cost value would become the Root Port more possibly.

Configured Path Cost:

The range is 0 – 200,000,000. In the switch, if path cost is set to be zero, the STP will get the recommended value resulted from auto-negotiation of the link accordingly and display this value in the field of Path Cost Status. Otherwise, it may show the value that the administrator set up in Configured Path Cost and Path Cost Status.

802.1w RSTP recommended value: (Valid range: 1 – 200,000,000)

10 Mbps : 2,000,000

100 Mbps : 200,000

1 Gbps : 20,000

Default: 0

Priority:

Priority here means Port Priority. Port Priority and Port Number are mixed to form the Port ID. Port IDs are often compared in order to determine which port of a bridge would become the Root Port. The range is 0 – 240.

Default is 128.

Admin Edge Port:

If user selects “Yes”, this port will be an edge port. An Edge Port is a port connected to a device that knows nothing about STP or RSTP. Usually, the connected device is an end station. Edge Ports will immediately transit to forwarding state and skip the listening and learning state because the edge ports cannot create bridging loops in the network. This will expedite the convergence. When the link on the edge port toggles, the STP topology keeps unchanged. Unlike the designate port or root port though, an edge port will transit to a normal spanning-tree port immediately if it receives a BPDU.

Default: No

Admin Point To Point:

We say a port is a point-to-point link, from RSTP’s view, if it is in full-duplex mode but is shared link if it is in half-duplex mode. RSTP fast convergence can only happen on point-to-point links and on edge ports.

This can expedite the convergence because this will have the port fast transitioned to forwarding state.

There are three parameters, Auto, True and False, used to configure the type of the point-to-point link. If configure this parameter to be Auto, it means RSTP will use the duplex mode resulted from the auto-negotiation. In today's switched networks, most links are running in full-duplex mode. For sure, the result may be half-duplex, in this case, the port will not fast transition to Forwarding state. If it is set as True, the port is treated as point-to-point link by RSTP and unconditionally transitioned to Forwarding state. If it is set as False, fast transition to Forwarding state will not happen on this port.

Default: Auto

M Check:

Migration Check. It forces the port sending out an RSTP BPDU instead of a legacy STP BPDU at the next transmission. The only benefit of this operation is to make the port quickly get back to act as an RSTP port. Click **<M Check>** button to send a RSTP BPDU from the port you specified.

3-13 MSTP

The implementation of MSTP is according to IEEE 802.1Q 2005 Clause 13 – **Multiple Spanning Tree Protocol**. **MSTP** allows frames assigned to different VLANs to follow separate paths, each based on an independent Multiple Spanning Tree Instance (MSTI), within Multiple Spanning Tree (MST) Regions composed of LANs and or MST Bridges. Proper configuration of MSTP in an 802.1Q VLAN environment can ensure a loop-free data path for a group of vlans within an MSTI. Redundant path and load balancing in vlan environment is also achieved via this feature. A spanning tree instance called **CIST(Common and Internal Spanning Tree)** always exists . **Up to 64 more spanning tree instances (MSTIs) can be provisioned.**

3-13-1 Status

Function name:

MSTP State

Function description:

To enable or disable MSTP. And to select a version of Spanning Tree protocol which MSTP should operate on.

MSTP State	
Multiple Spanning Tree Protocol	Disable ▼
Force Version	MSTP ▼
<input type="button" value="Apply"/>	

Fig. 3-153 MSTP State

Parameter description:

Multiple Spanning Tree Protocol:

Disabled / Enabled

Force Version:

STP / RSTP / MSTP

3-13-2 Region Config

Function name:

MSTP Region Config

Function description:

To configure the basic identification of a MSTP bridge. Bridges participating in a common MST region must have the same Region Name and Revision Level.

The screenshot shows a configuration window titled "MSTP Region Config". It contains two input fields: "Region Name (0~32 characters)" with the value "mstpRegion1" and "Revision Level (0-65535)" with the value "0". Below the fields is a green "Apply" button.

Fig. 3-154 MSTP Region Config

Parameter description:

Region Name:

0-32 characters.(A variable length text string encoded within a fixed field of 32 octets , conforming to RFC 2271's definition of SnmpAdminString.)

Revision Level:

0-65535

3-13-3 Instance View

Function name:

MSTP Instance Config

Function description:

Providing an MST instance table which include information(vlan membership of a MSTI) of all spanning instances provisioned in the particular MST region which the bridge belongs to. Through this table, additional MSTP configuration data can be applied and MSTP status can be retrieved.

MSTP Instance Config	
Instance ID	Corresponding Vlans
0	0-4095

Fig. 3-155 MSTP Instance Config

MSTP Create MSTI/Add Vlan Mapping	
Instance ID (1-4095)	<input type="text"/>
Vlan Mapping (VID STRING)	<input type="text"/>
VID STRING Example	2.5-7.100-200.301.303.1000-1500 (Valid VID Range:1-4094)

Fig. 3-156 Edit MSTI / Vlan

Parameter description:

Instance ID:

Every spanning tree instance need to have a unique instance ID within 0~4095. Instance 0 (CIST) always exists and can not be deleted. Additional spanning instances (MSTIs) can be added or deleted. At least one vlan must be provisioned for an MSTI to declare the need for the MSTI to be existent.

Corresponding Vlans: (0-4095)

Multiple vlans can belong to an MSTI. All vlans that are not provisioned through this will be automatically assigned to Instance 0(CIST).

Edit MSTI / Vlan: Fig. 3-156

To add an MSTI and provide its vlan members or modify vlan members for a specific MSTI.

Del MSTI:

To delete an MSTI.

Del All MSTI:

Deleting all provisioned MSTIs at a time.

Instance Configuration: Fig. 3-157

To provision spanning tree performance parameters per instance.

Port Config: Fig. 3-158

To provision spanning tree performance parameters per instance per port.

Instance Status: Fig. 3-159

To show the status report of a particular spanning tree instance.

Port Status: Fig. 3-160

To show the status report of all ports regarding a specific spanning tree instance.

Parameter description:**Vlan Mapping:**

VID STRING

VID STRING Example:

2.5-7.100-200.301.303.1000-1500 (Valid VID Range:1-4094)

Instance Configuration (ID=0)

Priority (0-61440)	32768 ▾
Max. Age (6-40 sec)	20
Forward Delay (4-30 sec)	15
Max. Hops(6-40 sec)	20

Note: $2 * (\text{Forward Delay} - 1) \geq \text{Max Age}$

Max Age: available from 6 to 40. Recommended value is 20
 Forward Delay(sec): available from 4 to 30. Recommended value is 15
 Max Hops: available from 6 to 40. Recommended value is 20

Apply

Fig. 3-157 Instance Config

Parameter description:

Priority: The priority parameter used in the CIST(Common and Internal Spanning Tree) connection.

0 / 4096 / 8192 / 12288 / 16384 / 20480 / 24576 / 28672 / 32768 / 36864 / 40960 / 45056 / 49152 / 53248 / 57344 / 61440

MAX. Age:

6-40sec. The same definition as in the RSTP protocol.

Forward Delay:

4-30sec. The same definition as in the RSTP protocol.

MAX. Hops:

6-40sec. It's a new parameter for the multiple spanning tree protocol. It is used in the internal spanning tree instances. "CIST Remaining Hops" or "MSTI Remaining Hops" in the Spanning tree protocol message would decreased by one when the message is propagated to the neighboring bridge. If the Remaining Hops in a message is zero, the message (BPDU) would be regarded as invalid. Max Hops is used to specify the initial value of the Remaining Hops for *Regional Root Bridge (Either CIST Regional Root or MSTI Regional Root)*

Port Config of Instance 0								
Port Config								Migration Check
Port	Path Cost	Priority	Hello Time	Admin Edge	Admin P2P	Restricted Role	Restricted TCN	Mcheck
1	0	128	2	Yes	Auto	No	No	---
2	0	128	2	Yes	Auto	No	No	---
3	0	128	2	Yes	Auto	No	No	---
4	0	128	2	Yes	Auto	No	No	---
5	0	128	2	Yes	Auto	No	No	---
6	0	128	2	Yes	Auto	No	No	---
7	0	128	2	Yes	Auto	No	No	---
8	0	128	2	Yes	Auto	No	No	---
9	0	128	2	Yes	Auto	No	No	---
10	0	128	2	Yes	Auto	No	No	---
11	0	128	2	Yes	Auto	No	No	---
12	0	128	2	Yes	Auto	No	No	---

Fig. 3-158 Port Config

Parameter description:

Port:

1-24

Path Cost:

1 – 200,000,000

The same definition as in the RSTP specification. But in MSTP, this parameter can be respectively applied to ports of CIST and ports of any MSTI.

Priority:

0 / 16 / 32 / 48 / 64 / 80 / 96 / 112 / 128 / 144 / 160 / 176 / 192 / 208 / 224 / 240

The same definition as in the RSTP specification. But in MSTP, this parameter can be respectively applied to ports of CIST and ports of any MSTI.

Hello Time: (1 / 2)

In contrast with RSTP, Hello Time in MSTP is a per port setting for the CIST.

Admin Edge: (Yes / No)

The same definition as in the RSTP specification for the CIST ports.

Admin P2P: (Auto/ True/ False)

The same definition as in the RSTP specification for the CIST ports.

Restricted Role: (Yes/ No)

If “Yes” causes the Port not to be selected as Root Port for the CIST or any MSTI, even it has the best spanning tree priority vector. Such a Port will be selected as an Alternate Port after the Root Port has been selected. This parameter is “No” by default. If set, it can cause lack of spanning tree connectivity. It is set by a network administrator to prevent bridges external to a core region of the network influencing the spanning tree active topology, possibly because those bridges are not under the full control of the administrator.

Restricted TCN: (Yes/ No)

If “Yes” causes the Port not to propagate received topology change notifications and topology changes to other Ports. This parameter is “No” by default. If set it can cause temporary loss of connectivity after changes in a spanning trees active topology as a result of persistent incorrectly learned station location information. It is set by a network administrator to prevent bridges external to a core region of the network, causing address flushing in that region, possibly because those bridges are not under the full control of the administrator. or the status of MAC operation for the attached LANs transitions frequently.

Mcheck:

The same definition as in the RSTP specification for the CIST ports.

Instance Status (ID=0)	
MSTP State	Enabled
Force Version	RSTP
Bridge Max Age	20
Bridge Forward Delay	15
Bridge Max Hops	20
Instance Priority	32768
Bridge Mac Address	00:40:c7:01:02:33
CIST ROOT PRIORITY	32768
CIST ROOT MAC	00:40:c7:01:02:33
CIST EXTERNAL ROOT PATH COST	0
CIST ROOT PORT ID	0
CIST REGIONAL ROOT PRIORITY	32768
CIST REGIONAL ROOT MAC	00:40:c7:01:02:33
CIST INTERNAL ROOT PATH COST	0
CIST CURRENT MAX AGE	20
CIST CURRENT FORWARD DELAY	15
TIME SINCE LAST TOPOLOGY CHANGE(SECS)	1095
TOPOLOGY CHANGE COUNT(SECS)	0

[Refresh](#)

Fig. 3-159 Instance Status

Parameter description:

MSTP State:

MSTP protocol is Enable or Disable.

Force Version:

It shows the current spanning tree protocol version configured.

Bridge Max Age:

It shows the Max Age setting of the bridge itself.

Bridge Forward Delay:

It shows the Forward Delay setting of the bridge itself.

Bridge Max Hops:

It shows the Max Hops setting of the bridge itself.

Instance Priority:

Spanning tree priority value for a specific tree instance(CIST or MSTI)

Bridge Mac Address:

The Mac Address of the bridge itself.

CIST ROOT PRIORITY:

Spanning tree priority value of the CIST root bridge

CIST ROOT MAC:

Mac Address of the CIST root bridge

CIST EXTERNAL ROOT PATH COST:

Root path cost value from the point of view of the bridge's MST region.

CIST ROOT PORT ID:

The port ID of the bridge's root port. In MSTP, peer port of a root port may reside in different MST region or in the same MST region. The first case indicates that the root port's owner is the CIST regional root bridge.

CIST REGIONAL ROOT PRIORITY:

Spanning tree priority value of the CIST regional root bridge. Note that CIST Regional Root bridge is different from CIST Root bridge. One exception is that when a bridge belonging to an MST region happens to be the root bridge of the CST (Common Spanning Tree). An MST Region in the CST can be regarded as a common RSTP bridge. The IST (Internal Spanning Tree) and MSTIs are transparent to bridges outside this region.

CIST REGIONAL ROOT MAC:

Mac Address of the CIST regional root bridge.

CIST INTERNAL ROOT PATH COST:

Root path cost value from the point of view of the bridges inside the IST.

CIST CURRENT MAX AGE:

Max Age of the CIST Root bridge.

CIST CURRENT FORWARD DELAY:

Forward Delay of the CIST Root bridge.

TIME SINCE LAST TOPOLOGY CHANGE(SECs):

Time Since Last Topology Change is the elapsed time in unit of seconds for a bunch of “Topology Change and(or) Topology Change Notification receiving” to occur. When new series of Topology Changes occur again, this counter will be reset to 0.

TOPOLOGY CHANGE COUNT(SECs):

The per spanning tree instance Topology Change Count expresses the time spent in unit of seconds since the beginning of the Spanning Tree Topology Change to the end of the STP convergence. Once there is no topology change occurring and no more topology change notification received, the Topology Change count will be reset to 0.

Port Status of Instance 0									
Refresh									
Port No	Status	Role	Path Cost	Priority	Hello	Oper. Edge	Oper. P2P	Restricted Role	Restricted Tcn
1	FORWARDING	DSGN	20000	128	2/2	√	√		
2	DISCARDING	dsbl	2000000	128	2/2	√			
3	DISCARDING	dsbl	2000000	128	2/2	√			
4	DISCARDING	dsbl	2000000	128	2/2	√			
5	DISCARDING	dsbl	2000000	128	2/2	√			
6	DISCARDING	dsbl	2000000	128	2/2	√			
7	DISCARDING	dsbl	2000000	128	2/2	√			
8	DISCARDING	dsbl	2000000	128	2/2	√			
9	DISCARDING	dsbl	2000000	128	2/2	√			
10	DISCARDING	dsbl	2000000	128	2/2	√			
11	DISCARDING	dsbl	2000000	128	2/2	√			
12	DISCARDING	dsbl	2000000	128	2/2	√			

Fig. 3-160 Port Status

Parameter description:**Port No:**

1-24

Status:

The forwarding status. Same definition as of the RSTP specification
Possible values are “FORWARDING”, “LEARNING”, “DISCARDING”

Status:

The role that a port plays in the spanning tree topology. Possible values are "dsbl"(disable port) , "alt"(alternate port) , "bkup"(backup port) , "ROOT"(root port) , "DSGN"(designated port) , "MSTR"(master port). The last 3 are possible port roles for a port to transit to FORWARDING state

Path Cost:

Display currently resolved port path cost value for each port in a particular spanning tree instance.

Priority:

Display port priority value for each port in a particular spanning tree instance.

Hello:

per port Hello Time display. It takes the following form:

Current Hello Time/Hello Time Setting

Oper. Edge:

Whether or not a port is an Edge Port in reality.

Oper. P2P:

Whether or not a port is a Point-to-Point Port in reality.

Restricted Role:

Same as mentioned in "Port Config"

Restricted Tcn:

Same as mentioned in "Port Config"

3-14. Mirror

Function name:

Mirror Configuration

Function description:

Mirror Configuration is to monitor the traffic of the network. For example, we assume that Port A and Port B are Monitoring Port and Monitored Port respectively, thus, the traffic received by Port B will be copied to Port A for monitoring.

Note:

When configure the mirror function, you should avoid setting a port to be a sniffer port and aggregated port at the same time. It will cause something wrong.

Port #	Source Enable	Destination Enable
1	<input type="checkbox"/>	<input type="checkbox"/>
2	<input type="checkbox"/>	<input type="checkbox"/>
3	<input type="checkbox"/>	<input type="checkbox"/>
4	<input type="checkbox"/>	<input type="checkbox"/>
5	<input type="checkbox"/>	<input type="checkbox"/>
6	<input type="checkbox"/>	<input type="checkbox"/>
7	<input type="checkbox"/>	<input type="checkbox"/>
8	<input type="checkbox"/>	<input type="checkbox"/>
9	<input type="checkbox"/>	<input type="checkbox"/>
10	<input type="checkbox"/>	<input type="checkbox"/>
11	<input type="checkbox"/>	<input type="checkbox"/>
12	<input type="checkbox"/>	<input type="checkbox"/>
13	<input type="checkbox"/>	<input type="checkbox"/>
14	<input type="checkbox"/>	<input type="checkbox"/>
15	<input type="checkbox"/>	<input type="checkbox"/>

Fig. 3-161 Mirror Configuration

Parameter description:

Port to mirror to:

Range: Disabled / Port 1-24

Set the monitoring port.

Port #:

Range: 1-24

Select the monitored ports.

Source Enable:

The source enable means the monitored port ingress traffic will be copied to monitoring port.

Destination Enable:

The destination enable means the monitored port egress traffic will be copied to monitoring port.

3-15. Multicast

The function, Multicast, is used to establish the multicast groups to forward the multicast packet to the member ports, and, in nature, avoids wasting the bandwidth while IP multicast packets are running over the network. This is because a switch that does not support IGMP or IGMP Snooping can not tell the multicast packet from the broadcast packet, so it can only treat them all as the broadcast packet. Without IGMP Snooping, the multicast packet forwarding function is plain and nothing is different from broadcast packet.

A switch supported IGMP Snooping with the functions of query, report and leave, a type of packet exchanged between IP Multicast Router/Switch and IP Multicast Host, can update the information of the Multicast table when a member (port) joins or leaves an IP Multicast Destination Address. With this function, once a switch receives an IP multicast packet, it will forward the packet to the members who joined in a specified IP multicast group before.

The packets will be discarded by the IGMP Snooping if the user transmits multicast packets to the multicast group that had not been built up in advance.

3-15-1 IGMP Mode

Function name:

IGMP Mode

Function description:

IGMP mode to select the switch to issue IGMP host messages on behalf of hosts that the system discovered through standard IGMP interfaces. The switch acts as a *proxy or snooping* for its hosts.



Fig. 3-162 IGMP Proxy

Parameter description:

Disable:

To disable the IGMP service on the switch.

Proxy :

To select and enable the IGMP mode with a proxy on the switch.

Snooping:

To select and enable the IGMP mode with a snooping on the switch.

3-15-2 IGMP Proxy

Function name:

IGMP Proxy Configuration

Function description:

IGMP proxy enables the switch to issue IGMP host messages on behalf of hosts that the system discovered through standard IGMP interfaces. The switch acts as a *proxy* for its hosts.

You enable IGMP proxy on the switch, which connects to a router closer to the root of the tree. This interface is the *upstream interface*. The router on the upstream interface should be running IGMP.

IGMP Proxy Configuration

General Query Interval	<input type="text" value="125"/>	(seconds: 1 ~ 3600)
General Query Response Timeout	<input type="text" value="11"/>	(seconds: 1 ~ 25)
General Query Max Response Time	<input type="text" value="10"/>	(seconds: 1 ~ 25)
Last Member Query Count	<input type="text" value="2"/>	(times: 1 ~ 16)
Last Member Query Interval	<input type="text" value="1"/>	(seconds: 1 ~ 25)
Last Member Query Max Response Time	<input type="text" value="1"/>	(seconds: 1 ~ 25)

Router Ports																	
1	2	3	4	5	6	7	8	9	10	11	12	13	14	15	16	17	18
<input type="checkbox"/>	<input type="checkbox"/>	<input type="checkbox"/>	<input type="checkbox"/>	<input type="checkbox"/>	<input type="checkbox"/>	<input type="checkbox"/>	<input type="checkbox"/>	<input type="checkbox"/>	<input type="checkbox"/>	<input type="checkbox"/>	<input type="checkbox"/>	<input type="checkbox"/>	<input type="checkbox"/>	<input type="checkbox"/>	<input type="checkbox"/>	<input type="checkbox"/>	<input type="checkbox"/>

Fig. 3-162 IGMP Proxy

Parameter description:

General Query Interval :

The general query interval is the amount of time in seconds between IGMP General Query messages sent by the router (if the router is the querier on this subnet).

Available value: 1-3600 sec

General Query Response Timeout :

The General Query Response Timeout field is the amount of time in seconds.

Available value: 1-25 sec

General Query Max Response Time :

The Maximum Response Time field is only used in general or group-specific query messages. The Maximum Response Time is configured as the value for the Query response interval setting

Available value: 1-25 sec

Last Member Query Count :

To set last member Query Count on Switch .

Available value: 1-16 times

Last Member Query Interval :

The last member query interval is the amount of time in seconds between IGMP last member Query messages sent by the router (if the router is the querier on this subnet).

Available value: 1-25 sec

Last Member Query Max Response Time :

To set the last member Query Response Time field is used in specific or group-specific query messages. The last member query Maximum Response Time is configured as the value.

Available value: 1-25 sec

3-15-3 Snooping

Function name:

Snooping

Function description:

IGMP snooping provide the switch to issue to prevent hosts on a local network from receiving traffic for a multicast group they have not explicitly joined. It provides switches with a mechanism to prune multicast traffic from links that do not contain a multicast listener (IGMP client). A switch that does not IGMP snoop will, by default, 'flood' multicast traffic to all the ports in a broadcast domain (or the VLAN equivalent). Multicast can cause unnecessary or even crippling load on host devices by requiring them to process packets they have not solicited

IGMP snooping Configuration

Host Time Out (seconds: 1 ~ 65535)

Fast Leave																		
1	2	3	4	5	6	7	8	9	10	11	12	13	14	15	16	17	18	19
<input type="checkbox"/>	<input type="checkbox"/>	<input type="checkbox"/>	<input type="checkbox"/>	<input type="checkbox"/>	<input type="checkbox"/>	<input type="checkbox"/>	<input type="checkbox"/>	<input type="checkbox"/>	<input type="checkbox"/>	<input type="checkbox"/>	<input type="checkbox"/>	<input type="checkbox"/>	<input type="checkbox"/>	<input type="checkbox"/>	<input type="checkbox"/>	<input type="checkbox"/>	<input type="checkbox"/>	<input type="checkbox"/>

Router Ports																		
1	2	3	4	5	6	7	8	9	10	11	12	13	14	15	16	17	18	19
<input type="checkbox"/>	<input type="checkbox"/>	<input type="checkbox"/>	<input type="checkbox"/>	<input type="checkbox"/>	<input type="checkbox"/>	<input type="checkbox"/>	<input type="checkbox"/>	<input type="checkbox"/>	<input type="checkbox"/>	<input type="checkbox"/>	<input type="checkbox"/>	<input type="checkbox"/>	<input type="checkbox"/>	<input type="checkbox"/>	<input type="checkbox"/>	<input type="checkbox"/>	<input type="checkbox"/>	<input type="checkbox"/>

Fig. 3-163-1 IGMP Snooping

Parameter description:

Host Time Out:

The IGMP Snooping Host query Timeout field is the amount of time in seconds.

Available value: 1-65535 sec

Fast Leave :

To evoke the port to become a Fast leave port in IGMP snooping service.

Router ports:

To evoke the port to become a Router port in IGMP snooping service.

Apply:

To save the configuration to switch memory.

3-15-4 Group Membership

Function name:

Group Membership

Function description:

To show the IGMP group members information, the you can edit the parameters for IGMP groups and members in the web user interface.

IGMP Group Membership

			Port Members																		
Index	Group Address	VLAN ID	1	2	3	4	5	6	7	8	9	10	11	12	13	14	15	16	17	18	

Fig. 3-163 IGMP Group Membership

Parameter description:

Index:

To display the IGMP group membership index information.

Group Address:

The switch supports managed valid IGMP Group membership IP Address range, It will show effective IP range. **The valid range is 224.0.0.0~239.255.255.255.**

VLAN ID:

The switch supports two kinds of options for managed valid VLAN VID, including "Any" and "Custom". Default is "Any". When you choose "Custom", you can fill in VID number. **The valid VID range is 1~4094.**

Port:

The switch supports two kinds of options for managed valid port range, including "Any" and "Custom". Default is "Any". You can select the ports that you would like them to be worked and restricted in the allowed group configuration if "Custom" had been chosen.

Previous Page:

To show previous page.

Next Page:

To show next page.

Refresh:

To refresh the IGMP Group membership information which caught by the switch .

3-15-5 MVR

Function name:

MVR Setting

Function description:

Multicast VLAN Registration (MVR) routes packets received in a multicast source VLAN to one or more receive VLANs. Clients are in the receive VLANs and the multicast server is in the source VLAN. Multicast routing has to be disabled when MVR is enabled. Refer to the configuration guide at Understanding Multicast VLAN Registration for more information on MVR.

MVR Configuration

MVR Configuration interface showing the following settings:

- MVR Enable:**
- Host Time Out:** 125 (seconds: 1 ~ 65535)
- Fast Leave:** A table with 24 columns (1-24) and checkboxes for each column.

Fast Leave																							
1	2	3	4	5	6	7	8	9	10	11	12	13	14	15	16	17	18	19	20	21	22	23	24
<input type="checkbox"/>	<input type="checkbox"/>	<input type="checkbox"/>	<input type="checkbox"/>	<input type="checkbox"/>	<input type="checkbox"/>	<input type="checkbox"/>	<input type="checkbox"/>	<input type="checkbox"/>	<input type="checkbox"/>	<input type="checkbox"/>	<input type="checkbox"/>	<input type="checkbox"/>	<input type="checkbox"/>	<input type="checkbox"/>	<input type="checkbox"/>	<input type="checkbox"/>	<input type="checkbox"/>	<input type="checkbox"/>	<input type="checkbox"/>	<input type="checkbox"/>	<input type="checkbox"/>	<input type="checkbox"/>	<input type="checkbox"/>

Apply

Fig. 3-163-1 MVR setting

Parameter description:

MVR Enable:

To Set the multicast VLAN registration function enable.

Host Time Out:

The MVR Host query Timeout field is the amount of time in seconds.

Available value: 1-65535 sec

Fast Leave :

To evoke the port to become a Fast leave port in MVR (Multicast VLAN Registration) service on the switch.

3-15-6 MVID

Function name:

MVID Configuration

Function description:

To create the Multicast VLAN Registration member and evoke the port with which mode as client or router.

Create MVID

MVID	<input type="text"/>																							
Port	1. disable	2. disable	3. disable	4. disable	5. disable	6. disable	7. disable	8. disable	9. disable	10. disable	11. disable	12. disable	13. disable	14. disable	15. disable	16. disable	17. disable	18. disable	19. disable	20. disable	21. disable	22. disable	23. disable	24. disable

Apply

Fig. 3-163-2 MVID configuration

Parameter description:

MVID:

The switch supports two kinds of options for managed valid VLAN VID, including “Client” and “router”. Default is “Disable”. When you choose “Client”, you can fill in MVID number. **The valid VID range is 1-4094.**

Port:

The switch supports two kinds of options for managed valid port range, including “Client” and “router”. Default is “Disable”. You can select the ports that you would like them to be worked and restricted in the allowed group configuration if “client” had been chosen.

3-15-7 Group Allow

Function name:

Group Allow

Function description:

The Group Allow function allows the IGMP Snooping to set up the IP multicast table based on user's specific conditions. IGMP report packets that meet the items you set up will be joined or formed the multicast group.

Group Allow

MVID	Start Address	End Address
<input type="text"/>	<input type="text"/>	<input type="text"/>

Apply

MVID	Start Address	End Address
<input type="text"/>	<input type="text"/>	<input type="text"/>

Delete

Fig. 3-163-3 Group Allow

Parameter description:

MVID:

The switch supports two kinds of options for managed valid VLAN VID, including "Client" and "router". Default is "disable". When you choose "Custom", you can fill in VID number. The valid VID range is 1~4094.

(Start Address to End Address) IP Range:

The switch supports two kinds of options for managed valid IP range, you can assigned effective IP range. The valid range is 224.0.0.0~239.255.255.255.

Add:

A new entry of allowed group configuration can be created after the parameters as mentioned above had been setup and then press **<Add>** button.

Edit:

The existed entry also can be modified after pressing **<Edit>** button.

Delete:

Remove the existed entry of allowed group configuration from the allowed group.

3-15-8 MVR Group Membership

Function name:

MVR Group Membership

Function description:

To show the MVR IGMP group members information, the you can edit the parameters for IGMP groups and members in the web user interface.

MVR Group Membership

			Port Members																			
Index	Group Address	MVID	1	2	3	4	5	6	7	8	9	10	11	12	13	14	15	16	17	18	19	20

Fig. 3-163-4 MVR Group Membership

Parameter description:

Index:

To display the MVR group membership index information.

Group Address:

The switch supports managed valid MVR Group membership IP Address range, It will show effective IP range. **The valid range is 224.0.0.0~239.255.255.255.**

MVID:

The switch supports two kinds of options for managed valid MVID, you can fill in VID number. **The valid VID range is 1~4094.**

Port:

The switch supports two kinds of options for managed valid port range, including “Any” and “Custom”. Default is “Any”. You can select the ports that you would like them to be worked and restricted in the allowed group configuration if “Custom” had been chosen.

Previous Page:

To show previous page.

Next Page:

To show next page.

Refresh:

To refresh the IGMP Group membership information which caught by the switch .

3-16. Alarm Configuration

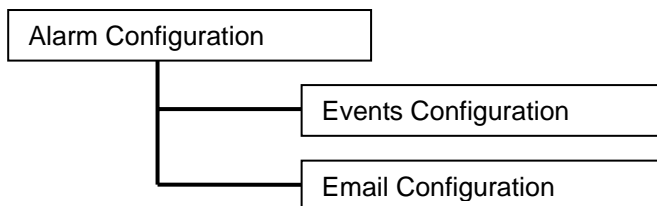

Fig.3-61

Function name:

Events Configuration

Function description:

The Trap Events Configuration function is used to enable the switch to send out the trap information while pre-defined trap events occurred. The switch offers 24 different trap events to users for switch management. The trap information can be sent out in two ways, including email and trap. The message will be sent while users tick (☑) the trap event individually on the web page shown as below.

Parameter description:

Trap: Cold Start, Warm Start, Link Down, Link Up, Authentication Failure, User login, User logout

STP: STP Topology Changed, STP Disabled, STP Enabled

LACP: LACP Disabled, LACP Enabled, LACP Member Added, LACP Port Failure

GVRP: GVRP Disabled, GVRP Enabled

VLAN: VLAN Disabled, Port-based VLAN Enabled, Tag-based VLAN Enabled, Metro-mode Vlan Enabled, Double-tag Vlan Enabled

Module Swap: Module Inserted, Module Removed, Dual Media Swapped

3-16-1 Events

Function name:

Email Configuration

Function description:

Alarm configuration is used to configure the persons who should receive the alarm message via either email. It depends on your settings. An email address has to be set in the web page of alarm configuration (**See Fig. 3-61**). Then, user can read the trap information from the email. This function provides 6 email addresses at most. The 24 different trap events will be sent out to SNMP Manager when trap event occurs. After ticking trap events, you can fill in your desired email addresses. Then, please click **<Apply>** button to complete the alarm configuration. It will take effect in a few seconds.

Event	Email	Trap
Cold Start	<input type="checkbox"/>	<input checked="" type="checkbox"/>
Warm Start	<input type="checkbox"/>	<input checked="" type="checkbox"/>
Link Down	<input type="checkbox"/>	<input checked="" type="checkbox"/>
Link Up	<input type="checkbox"/>	<input checked="" type="checkbox"/>
Authentication Failure	<input type="checkbox"/>	<input checked="" type="checkbox"/>
Login	<input type="checkbox"/>	<input type="checkbox"/>
Logout	<input type="checkbox"/>	<input type="checkbox"/>
Module Inserted	<input type="checkbox"/>	<input type="checkbox"/>
Module Removed	<input type="checkbox"/>	<input type="checkbox"/>
Dual Media Swapped	<input type="checkbox"/>	<input type="checkbox"/>
Looping Detected	<input type="checkbox"/>	<input type="checkbox"/>
STP Disabled	<input type="checkbox"/>	<input type="checkbox"/>

Apply

Fig. 3-164 Trap Events Configuration

3-16-2 Email

Parameter description:

Email:

Mail Server: the IP address of the server transferring your email.

Username: your username on the mail server.

Password: your password on the mail server.

Email Address 1 – 6: email address that would like to receive the alarm message.

Alarm Configuration	
Mail Server	<input type="text"/>
User Name	<input type="text"/>
Password	<input type="text"/>
Email Adress 1	<input type="text"/>
Email Adress 2	<input type="text"/>
Email Adress 3	<input type="text"/>
Email Adress 4	<input type="text"/>
Email Adress 5	<input type="text"/>
Email Adress 6	<input type="text"/>

Fig. 3-165 Alarm Configuration

3-17. DHCP Snooping

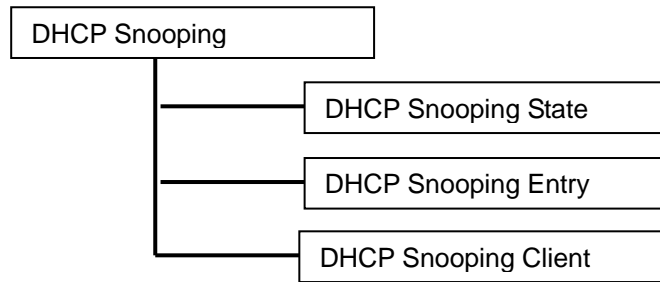

Fig.3-62

3-17-1. DHCP Snooping State

Function name:

DHCP Snooping State

Function description:

The addresses assigned to DHCP clients on unsecure ports can be carefully controlled using the dynamic bindings registered with DHCP Snooping. DHCP snooping allows a switch to protect a network from rogue DHCP servers or other devices which send port-related information to a DHCP server. This information can be useful in tracking an IP address back to a physical port.

DHCP Snooping State

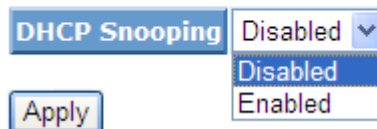

Fig. 3-17-1 DHCP Snooping State

Parameter description:

DHCP Snooping state: The parameter which set to disabled or enabled the DHCP snooping function on the switch, the default is **Disabled**.

Note: To click "**Apply**" when you finish the configuration.

3-17-2. DHCP Snooping Entry

Function name:

DHCP Snooping Entry

Function description:

DHCP snooping Entry allows a switch to add the an trust DHCP server and 2 trust port to build the DHCP snooping available entry. This information can be useful in tracking an IP address back to a physical port and enable or disable the DHCP Option 82.

VID	<input type="text"/>	Trust Port 1	Disable ▾	Trust Port 2	Disa
Turst VID	<input type="text"/>	Server IP	<input type="text"/>		
Option 82	Disable ▾	Action	Keep ▾		
<input type="button" value="Add"/>					

- Keep
- Drop
- Replace

Fig. 3-17-1 DHCP Snooping State

Parameter description:

VID : When DHCP snooping is enabled, and enabled on the specified VLAN, DHCP packet filtering will be performed on any un-trusted ports within the VLAN. It set a available VLAN ID to enable the DHCP snooping on VLAN interface.

Trust Port 1 : If DHCP snooping is enabled globally, and also enabled on the VLAN where the DHCP packet is received, all DHCP packets are forwarded for a trusted por. It set a trust port 1. available port from 0 to 24. 0 is disabled.

Trust port 2 : It set a trust port 2. available port from 0 to 24. 0 is disabled.

Trust VID : It set a trust VLAN ID. available VID from 1 to 4094.

Server IP : It set a trust DHCP Server IP address for DHCP Snooping.

Option 82 : It set the DHCP Option 82 function on the switch, default is Disable.

Action : It set the switch when received a client DHCP request packet then action for filtering. available action : keep/ drop / replace.

Note : Filtering rules are implemented as follows:

- ***If the DHCP snooping is disabled, all DHCP packets are forwarded.***
- ***If DHCP snooping is enabled and also enabled on the VLAN where the DHCP packet is received, all DHCP packets are forwarded for a trusted port.***
- ***If DHCP snooping is enabled and also enabled on the VLAN where the DHCP packet is received, but the port is not trusted, it is***

processed as follows:

- * *If the DHCP packet is a reply packet from a DHCP server, the packet is dropped.*
- * *If the DHCP packet is from a client, such as a DISCOVER, REQUEST INFORM, DECLINE or RELEASE message, the packet is forwarded if MAC address verification is disabled. However, if MAC address verification is enabled, then the packet will only be forwarded if the client's hardware address stored in the DHCP packet is the same as the source MAC address in the Ethernet header.*
- * *If the DHCP packet is not a recognizable type, it is dropped.*
- *If a DHCP packet from a client passes the filtering criteria above, it will only be forwarded to trusted ports in the same VLAN.*
- *If a DHCP packet from server is received on a trusted port, it will be forwarded to both trusted and un-trusted ports in the same VLAN.*

3-17-3. DHCP Snooping Client

Function name:

DHCP Snooping Client

Function description:

To show the DHCP snooping client.

DHCP Snooping Client				
MAC	VID	Port	IP	Lease
<input type="button" value="Delete"/>				

Fig. 3-17-2 DHCP Snooping Client

Parameter description:

MAC : To show the DHCP snooping client's MAC address.

VID : To show the DHCP snooping client's VLAN ID.

Port : To show the DHCP snooping client's port.

IP : To show the DHCP snooping client's IP address.

Lease : To show the DHCP snooping client's lease.

3-18. LLDP

The switch supports the LLDP. For current information on your switch model, The Link Layer Discovery Protocol (LLDP) provides a standards-based method for enabling switches to advertise themselves to adjacent devices and to learn about adjacent LLDP devices.

3-18-1 . LLDP State

Function name:

LLDP State

Function description:

The LLDP state function, you can set per port the LLDP configuration and the detail parameters, the settings will take effect immediately.

LLDP Configuration

LLDP Parameters

Tx Interval	30	seconds
Tx Hold	4	times
Tx Delay	2	seconds
Tx Reinit	2	seconds
Notification Interval	5	seconds

Port	Mode	Port Descr	Optional TLVs					Notification
			Sys Name	Sys Descr	Sys Capa	Mgmt Addr		
1	Disabled	<input checked="" type="checkbox"/>	<input checked="" type="checkbox"/>	<input checked="" type="checkbox"/>	<input checked="" type="checkbox"/>	<input checked="" type="checkbox"/>	<input checked="" type="checkbox"/>	<input type="checkbox"/>
2	Disabled	<input checked="" type="checkbox"/>	<input checked="" type="checkbox"/>	<input checked="" type="checkbox"/>	<input checked="" type="checkbox"/>	<input checked="" type="checkbox"/>	<input checked="" type="checkbox"/>	<input type="checkbox"/>
3	Disabled	<input checked="" type="checkbox"/>	<input checked="" type="checkbox"/>	<input checked="" type="checkbox"/>	<input checked="" type="checkbox"/>	<input checked="" type="checkbox"/>	<input checked="" type="checkbox"/>	<input type="checkbox"/>
4	Disabled	<input checked="" type="checkbox"/>	<input checked="" type="checkbox"/>	<input checked="" type="checkbox"/>	<input checked="" type="checkbox"/>	<input checked="" type="checkbox"/>	<input checked="" type="checkbox"/>	<input type="checkbox"/>
5	Disabled	<input checked="" type="checkbox"/>	<input checked="" type="checkbox"/>	<input checked="" type="checkbox"/>	<input checked="" type="checkbox"/>	<input checked="" type="checkbox"/>	<input checked="" type="checkbox"/>	<input type="checkbox"/>
6	Disabled	<input checked="" type="checkbox"/>	<input checked="" type="checkbox"/>	<input checked="" type="checkbox"/>	<input checked="" type="checkbox"/>	<input checked="" type="checkbox"/>	<input checked="" type="checkbox"/>	<input type="checkbox"/>
7	Disabled	<input checked="" type="checkbox"/>	<input checked="" type="checkbox"/>	<input checked="" type="checkbox"/>	<input checked="" type="checkbox"/>	<input checked="" type="checkbox"/>	<input checked="" type="checkbox"/>	<input type="checkbox"/>
8	Disabled	<input checked="" type="checkbox"/>	<input checked="" type="checkbox"/>	<input checked="" type="checkbox"/>	<input checked="" type="checkbox"/>	<input checked="" type="checkbox"/>	<input checked="" type="checkbox"/>	<input type="checkbox"/>

Fig. 3-18-1 LLDP parameter

Parameter description:

- Tx Interval** : To changes the interval between consecutive transmissions of LLDP advertisements on any given port. **(Default: 30 secs)**
- Tx Hold** : The specifies the amount of time the receiving device holds a Link Layer Discovery Protocol (LLDP) packet before discarding it. **(Default: 4 times)**
- Tx Delay** : The specifies the delay between successive LLDP frame transmissions initiated by value/status changes in the LLDP local systems MIB. **(Default: 2 secs)**
- Tx Reinit** : The specifies the minimum time an LLDP port waits before reinitializing LLDP transmission. **(Default: 2 secs)**

Notification

Interval: A network management application can periodically check the switch MIB to detect any missed change notification traps. Refer to IEEE 802.1AB-2005 or later for more information.

(Default: 5 secs)

Mode : To enable or disable the LLDP mode per port. There are four type includes Disable, Tx_Rx, Tx only and Rx only

Port Descr : To evoke the outbound LLDP advertisements, includes an alphanumeric string describing the port.

Sys Name : To evoke the outbound LLDP advertisements, includes the system's assigned name

Sys Descr : To evoke outbound LLDP advertisements, includes an alphanumeric string describing the full name and version identification for the system's hardware type, software version, and networking application.

Sys Capa : To evoke outbound advertisements, includes a bitmask of system capabilities (device functions) that are supported. Also includes information on whether the capabilities are enabled.

Mgmt Addr : To evoke outbound advertisements, includes information on management address. you can use to include a specific IP address in the outbound LLDP advertisements for specific ports

Notification : To evoke outbound advertisements, includes information on Notification.

3-18-2 . LLDP Entry

Function name:

LLDP Entry

Function description:

The LLDP Entry function allows a switch to display per port which build the LLDP available entry. This information can be useful in tracking LLDP packets back to a physical port and enable or disable the LLDP.

LLDP Neighbor Information

Auto-refresh Refresh

Local Port	Chassis ID	Remote Port ID	System Name	Port Description	System Capabilities	Management Address
------------	------------	----------------	-------------	------------------	---------------------	--------------------

Fig. 3-18-2 LLDP Entry

Parameter description:

Local port:

To display the switch local port.

Chassis ID:

To display the Chassis ID which connect to the switch and what the neighbor Chassis ID.

Remote Port ID:

To display the Remote Port ID which connect to the switch and what the neighbor's remote port ID.

System name:

To display the system name which connect to the switch and which device supports the LLDP

Port Description:

To display an alphanumeric string describing the full name and version identification for the system's hardware type, software version, and networking application

System Capabilities:

To display an includes a bitmask of system capabilities (device functions)

that are supported. Also includes information on whether the capabilities are enabled.

Management Address:

To display include a specific IP address in the outbound LLDP advertisements for specific ports.

Auto - refresh:

Refresh the authenticator counters in the web UI automatically

Refresh:

Click on the <Refresh> to update the authenticator counters in the web UI

3-18-3 . LLDP Statistics

Function name:

LLDP Statistics

Function description:

Display the detailed counting number of each port's LLDP traffic.

LLDP Statistics

Auto-refresh Refresh Clear

Global Counters	
Neighbor entries were last changed at 7821 sec. ago	
Total Neighbors Entries Added	0
Total Neighbors Entries Deleted	0
Total Neighbors Entries Dropped	0
Total Neighbors Entries Aged Out	0

LLDP Statistics

Local Port	Local Counters						
	Tx Frames	Rx Frames	Rx Errors	Frames Discarded	TLVs Discarded	TLVs Unrecognized	Age-Outs
1	0	0	0	0	0	0	0
2	0	0	0	0	0	0	0
3	0	0	0	0	0	0	0
4	0	0	0	0	0	0	0
5	0	0	0	0	0	0	0
6	0	0	0	0	0	0	0
7	0	0	0	0	0	0	0
8	0	0	0	0	0	0	0

Fig. 3-18-3 LLDP statistics

Parameter description:

Neighbor entries were last changed at :

The time period which neighbor entries were be changed .

Total Neighbors Entries Added:

The total neighbors entries added be received.

Total Neighbors Entries Deleted:

The total neighbors entries deleted be received.

Total Neighbors Entries Dropped:

The total neighbors entries dropped be received.

Total Neighbors Entries Aged Out:

The total neighbors entries aged out be received.

Local port:

Show the local port on the switch.

Tx Frames:

The counting number of the frames transmitted.

Rx Frames:

The counting number of the frames transmitted.

Frames Discarded:

Show the number of frame discarded.

TLVs Discarded:

Show the number of TLVs discarded.

TLVs Unrecognized:

Show the number of TLVs unrecognized.

Age Outs:

Show the number of Age Outs.

3-19. Save/ Restore

The switch supports three copies of configuration, including the default configuration, working configuration and user configuration for your configuration management. All of them are listed and described below respectively.

- **Default Configuration:**

This is ex-factory setting and cannot be altered. In Web UI, two restore default functions are offered for the user to restore to the default setting of the switch. One is the function of *“Restore Default Configuration included default IP address”*, the IP address will restore to default “192.168.1.1” as you use it. The other is the function of *“Restore Default Configuration without changing current IP address”*, the IP address will keep the same one that you had saved before by performing this function.

- **Working Configuration:**

It is the configuration you are using currently and can be changed any time. The configurations you are using are saved into this configuration file. This is updated each time as you press **<Apply>** button.

- **User Configuration:**

It is the configuration file for the specified or backup purposes and can be updated while having confirmed the configuration. You can retrieve it by performing Restore User Configuration.

3-19-1. Factory Defaults

Function name:

Restore Default Configuration (includes default IP address)

Function description:

Restore Default Configuration function can retrieve ex-factory setting to replace the start configuration. And the IP address of the switch will also be restored to 192.168.1.1.

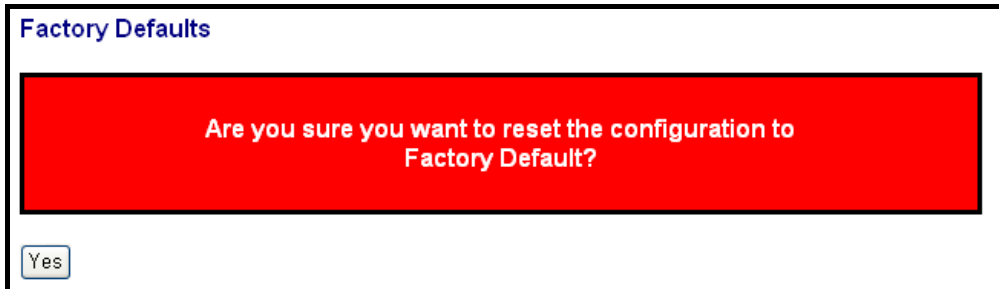

Fig. 3-166 Factory Defaults

3-19-2 . Save Start

Function name:

Save As Start Configuration

Function description:

Save the current configuration as a start configuration file in flash memory.

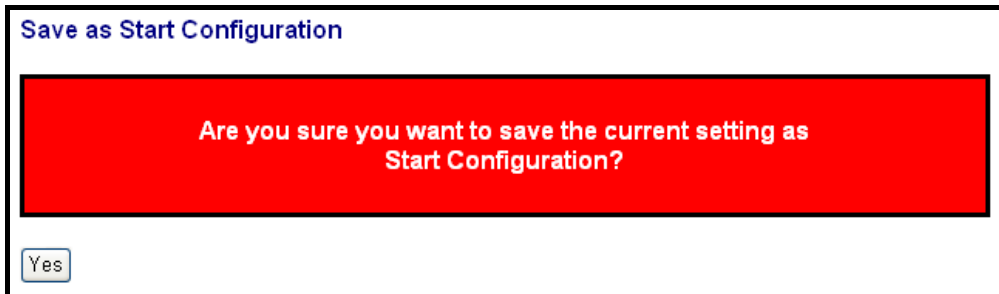

Fig. 3-167 Save as Start Configuration

3-19-3 . Save User

Function name:

Save As User Configuration

Function description:

Save the current configuration as a user configuration file in flash memory.

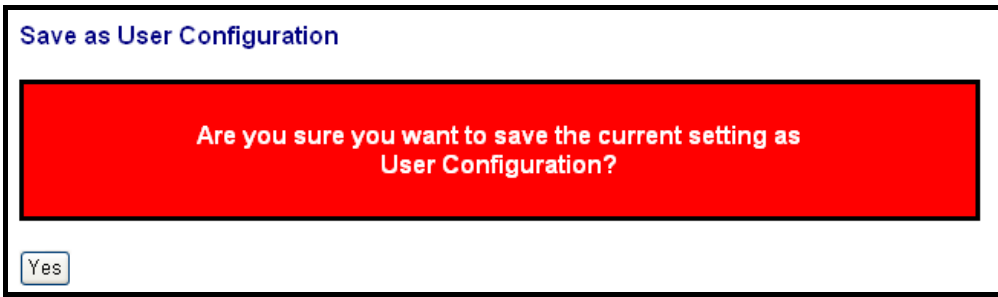

Fig. 3-168 Save as User Configuration

3-19-4 . Restore User

Function name:

Restore User Configuration

Function description:

Restore User Configuration function can retrieve the previous confirmed working configuration stored in the flash memory to update start configuration. When completing to restore the configuration, the system's start configuration is updated and will be changed its system settings after rebooting the system.

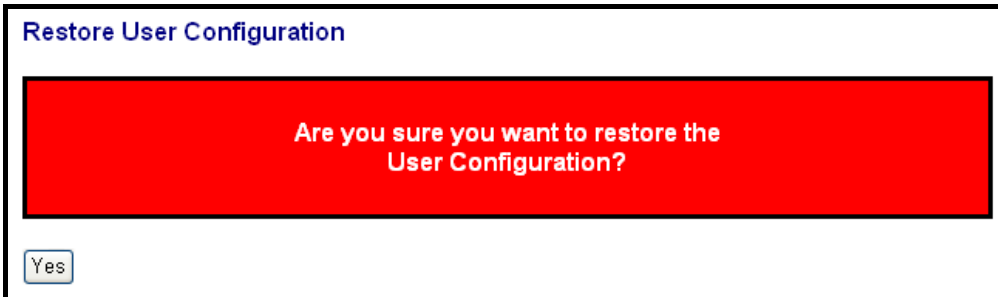

Fig. 3-169 Restore User Configuration

3-20. Export/ Import

Function name:

Export/ Import

Function description:

With this function, user can back up or reload the configuration files of Save As Start or Save As User via TFTP.

Parameter description:

Export File Path:

Export Start:

Export Save As Start's config file stored in the flash.

Export User-Conf:

Export Save As User's config file stored in the flash.

Import File Path:

Import Start:

Import Save As Start's config file stored in the flash.

Import User-Conf:

Import Save As User's config file stored in the flash.

The screenshot shows a web-based interface for configuration management. It is titled "Export Configuration File" in blue. Below the title, there is a section for exporting: "Export" followed by a dropdown menu currently set to "Current", then "Configuration File" and an "Export" button. Below this is a section for importing: "Import Start Configuration File" followed by an empty text input field, a "Browse" button, and an "Import" button. At the bottom is another section: "Import User Configuration File" followed by another empty text input field, a "Browse" button, and an "Import" button.

Fig. 3-170 Export/ Import Configuration

3-21. Diagnostics

Three functions, including Diagnostics, Loopback Test and Ping Test are contained in this function folder for device self-diagnostics. Each of them will be described in detail orderly in the following sections.

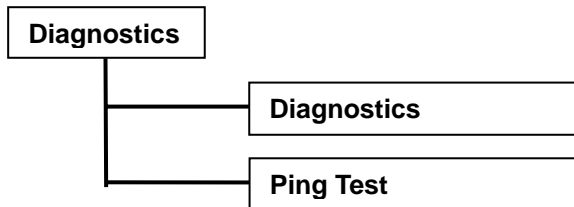

3-21-1 . Diag

Function name:

Diagnostics

Function description:

Diagnostics function provides a set of basic system diagnosis. It let users know that whether the system is health or needs to be fixed. The basic system check includes EEPROM test, UART test, DRAM test and Flash test.

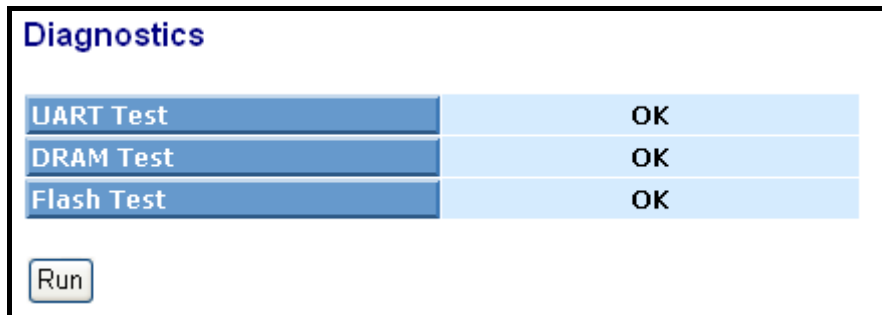

Fig. 3-171 Diagnostics

3-21-2 .Ping

Function name:

Ping Test

Function description:

Ping Test function is a tool for detecting if the target device is alive or not through ICMP protocol which abounds with report messages. The switch provides Ping Test function to let you know that if the target device is available or not. You can simply fill in a known IP address and then click **<Ping>** button. After a few seconds later, the switch will report you the pinged device is alive or dead in the field of Ping Result.

Parameter description:

IP Address:

An IP address with the version of v4, e.g. 192.168.1.1.

Default Gateway:

IP address of the default gateway.

For more details, please see the section of IP address in Chapter 2.

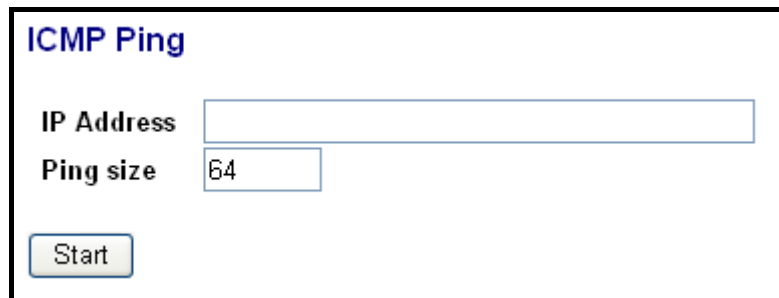

The image shows a web-based configuration interface for an ICMP Ping test. The title is "ICMP Ping" in blue text. Below the title, there are two input fields: "IP Address" with a long empty text box, and "Ping size" with a text box containing the number "64". At the bottom left of the form is a "Start" button.

Fig. 3-172 ICMP Ping

3-22 Maintenance

This chapter will introduce the reset and firmware upgrade function for the firmware upgrade and key parameters change system maintenance requirements.

3-22-1 .Reset Device

Function name:

Reset Device

Function description:

We offer you many ways to reset the switch, including power up, hardware reset and software reset. You can press the RESET button in the front panel to reset the switch. After upgrading software, changing IP configuration or changing VLAN mode configuration, then you must reboot to have the new configuration taken effect. Here we are discussing is software reset for the “reboot” in the main menu.

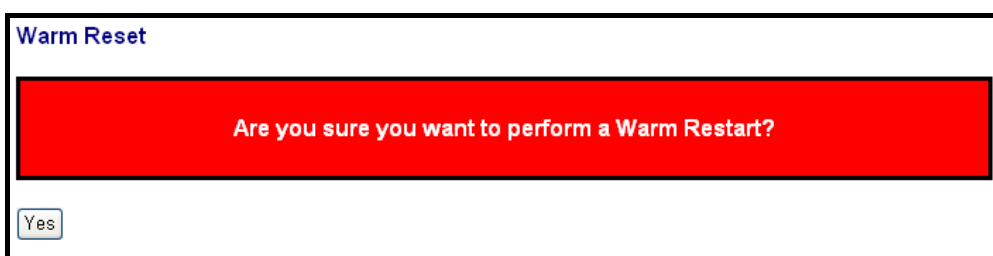

Fig. 3-174 Warm Reset

3-22-2 .Software Upload

Function name:

Software Upload

Function description:

Click on **<Browse>** to select a specific GEFXL2P-SW24 firmware file from the Web management PC, then click on **<Upload>** to confirm the upgrade firmware action. The new firmware will be uploaded into the switch and write into flash memory. You have to reboot the switch for new firmware take effect after the firmware upgrade successfully.



Fig. 3-175 Firmware Update

3-23 Logout

You can manually logout by performing Logout function. In the switch, it provides another way to logout. You can configure it to logout automatically.

Function name:

Logout

Function description:

The switch allows you to logout the system to prevent other users from the system without the permission. If you do not logout and exit the browser, the switch will automatically have you logout in five minutes. Besides this manually logout.

Parameter description:

Logout:

Click on **<Logout>** to leave the web UI management function.

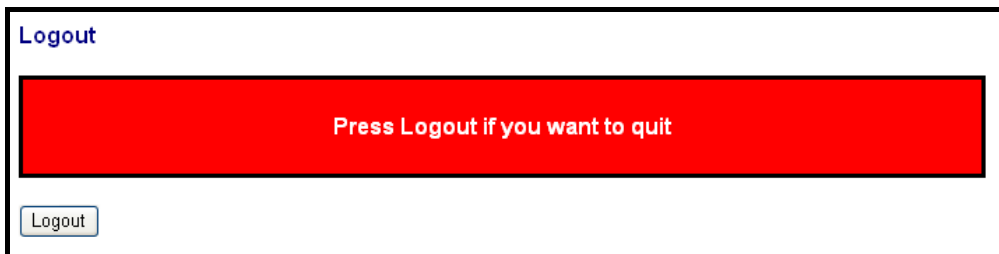

Fig. 3-176 Logout

4. Operation of CLI Management

4-1. CLI Management

Refer to **Chapter 2** for basic installation. The following description is the brief of the network connection.

- Locate the correct DB-9 null modem cable with female DB-9 connector. Null modem cable comes with the management switch. Refer to the Appendix B for null modem cable configuration.
- Attach the DB-9 female connector to the male DB-9 serial port connector on the Management board.
- Attach the other end of the DB-9 cable to an ASCII terminal emulator or PC Com-1, 2 port. For example, PC runs Microsoft Windows HyperTerminal utility.
- At "Com Port Properties" Menu, configure the parameters as below: (see the next section)

Baud rate	115200
Stop bits	1
Data bits	8
Parity	N
Flow control	none

4-1-1. Login

The command-line interface (CLI) is a text-based interface. User can access the CLI through either a direct serial connection to the device or a Telnet session. The default values of the managed switch are listed below:

Username: admin
Password: admin

After you login successfully, the prompt will be shown as "#" if you are the first login person and your authorization is administrator; otherwise it may show "\$". See the following two figures. The former means you behave as an administrator and have the access right of the system. As to the latter, it means you behave as a guest and are only allowed to view the system without the permission to do any setting for this switch.

```
Managed Switch - GEFXL2P-SW24
Login: admin
Password: *****
GEFXL2P-SW24#
```

Fig. 4-1

```
Managed Switch - GEFXL2P-SW24
Login: admin
Password: *****
GEFXL2P-SW24$ █
```

Fig. 4-2

4-2. Commands of CLI

To see the commands of the mode, please input “?” after the prompt, then all commands will be listed in the screen. All commands can be divided into two categories, including global commands and local commands. Global commands can be used wherever the mode you are. They are “exit”, “end”, “help”, “history”, “logout”, “save start”, “save user”, “restore default” and “restore user”. For more details, please refer to Section 4-2-1.

Command instructions reside in the corresponding modes are local commands. The same command with the same command name may occur but perform totally different function in different modes. For example, “show” in IP mode performs displaying the IP information; however, it performs displaying the system information in system mode. *For more details, please refer to Section 4-2-2.*

```
Managed Switch - GEFXL2P-SW24
Login: admin

Password: *****

GEFXL2P-SW24$ ?
 802.1X          Enter into 802.1X mode
 account        Enter into account mode
 acl            Enter into acl mode
 alarm          Enter into alarm mode
 autologout     Change autologout time
 config-file    Enter into config file mode
 igmp           Enter into igmp mode
 ip            Enter into ip mode
 ip_mac_binding Enter into ip mac binding mode
 loop-detection Enter into Loop Detection(LD) mode
 mac           Enter into mac mode
 mirror        Enter into mirror mode
 mstp          Enter into mstp mode
 policy        Enter into Management Policy mode
 port         Enter into port mode
 qos          Enter into qos mode
 snmp         Enter into snmp mode
 stp          Enter into stp mode
 system       Enter into system mode
```

Fig. 4-3

4-2-1. Global Commands of CLI

end

Syntax:

end

Description:

Back to the top mode.

When you enter this command, your current position would move to the top mode. If you use this command in the top mode, you are still in the position of the top mode.

Argument:

None.

Possible value:

None.

Example:

```
GEFXL2P-SW24# alarm
GEFXL2P-SW24(alarm)# events
GEFXL2P-SW24(alarm-events)# end

GEFXL2P-SW24#
```

exit

Syntax:

exit

Description:

Back to the previous mode.

When you enter this command, your current position would move back to the previous mode. If you use this command in the top mode, you are still in the position of the top mode.

Argument:

None.

Possible value:

None.

Example:

```
GEFXL2P-SW24# trunk
GEFXL2P-SW24(trunk)# exit

GEFXL2P-SW24#
```

help

Syntax:

help

Description:

To show available commands.

Some commands are the combination of more than two words. When you enter this command, the CLI would show the complete commands. Besides, the command would help you classify the commands between the local commands and the global ones.

Argument:

None.

Possible value:

None.

Example:

```
GEFXL2P-SW24# ip
GEFXL2P-SW24(ip)# help
Commands available:
-----<< Local commands >>-----
set ip           Set ip, subnet mask and gateway
set dns          Set dns
enable dhcp      Enable DHCP, and set dns auto or manual
disable dhcp     Disable DHCP
show             Show IP Configuration
-----<< Global commands >>-----
exit             Back to the previous mode
end              Back to the top mode
help             Show available commands
history          Show a list of previously run commands
logout           Logout the system
save start       Save as start config
save user        Save as user config
restore default  Restore default config
restore user     Restore user config
```

history

Syntax:

history [#]

Description:

To show a list of previous commands that you had ever run.

When you enter this command, the CLI would show a list of commands which you had typed before. The CLI supports up to 256 records. If no argument is typed, the CLI would list total records up to 256. If optional argument is given, the CLI would only show the last numbers of records, given by the argument.

Argument:

[#]: show last number of history records. (optional)

Possible value:

[#]: 1, 2, 3,, 256

Example:

```
GEFXL2P-SW24(ip)# history
Command history:
 0. trunk
 1. exit
 2. GEFXL2P-SW24# trunk
 3. GEFXL2P-SW24(trunk)# exit
 4. GEFXL2P-SW24#
 5. ?
 6. trunk
 7. exit
 8. alarm
 9. events
10. end
11. ip
12. help
13. ip
14. history
```

```
GEFXL2P-SW24(ip)# history 3
Command history:
13. ip
14. history
15. history 3
```

```
GEFXL2P-SW24(ip)#
```

logout

Syntax:

logout

Description:

When you enter this command via Telnet connection, you would logout the system and disconnect. If you connect the system through direct serial port with RS-232 cable, you would logout the system and be back to the initial login prompt when you run this command.

Argument:

None.

Possible value:

None.

Example:

```
GEFXL2P-SW24# logout
```

restore default

Syntax:

restore default

Description:

When you use this function in CLI, the system will show you the information "Do you want to restore the default IP address?(y/n)". If you choose Y or y, the IP address will restore to default "192.168.1.1". If you choose N or n, the IP address will keep the same one that you had saved before.

If restoring default successfully, the CLI would prompt if reboot immediately or not. If you press Y or y, the system would reboot immediately; otherwise, it would be back to the CLI system. After restoring default configuration, all the changes in the startup configuration would be lost. After rebooting, the entire startup configuration would reset to factory default.

Argument:

None.

Possible value:

None.

Example:

```
GEFXL2P-SW24# restore default
Restoring ...
Restore Default Configuration Successfully
Press any key to reboot system.
```

restore user

Syntax:

restore user

Description:

To restore the startup configuration as user defined configuration. If restoring default successfully, the CLI would prompt if reboot immediately or not. If you press Y or y, the system would reboot immediately; others would back to the CLI system. After restoring user-defined configuration, all the changes in the startup configuration would be lost. After rebooting, the entire startup configuration would replace as user defined one.

Argument:

None.

Possible value:

None.

Example:

```
GEFXL2P-SW24# restore user
Restoring ...
Restore User Configuration Successfully
Press any key to reboot system.
```

save start

Syntax:

save start

Description:

To save the current configuration as the start one. When you enter this command, the CLI would save your current configuration into the non-volatile FLASH. If you want the configuration still works after rebooting, save the configuration using the command 'save start'.

Argument:

None.

Possible value:

None.

Example:

```
GEFXL2P-SW24# save start
Saving start...
Save Successfully

GEFXL2P-SW24#
```

save user

Syntax:

save user

Description:

To save the current configuration as the user-defined configuration. When you enter this command, the CLI would save your current configuration into the non-volatile FLASH as user-defined configuration.

Argument:

None.

Possible value:

None.

Example:

```
GEFXL2P-SW24# save user
Saving user...
Save Successfully
```

```
GEFXL2P-SW24#
```

4-2-2. Local Commands of CLI

■ 802.1X

set maxReq

Syntax:

set maxReq <port-range> <vlaue>

Description:

The maximum number of times that the state machine will retransmit an EAP Request packet to the Supplicant before it times out the authentication session.

Argument:

<port range> : syntax 1,5-7, available from 1 to 24

<value>: max-times , range 1-10

Possible value:

<port range> : 1 to 24

<value>: 1-10, default is 2

Example:

```
GEFXL2P-SW24(802.1X)# set maxReq 2 2
```

set mode

Syntax:

set mode <port-range> <mode>

Description:

To set up the 802.1X authentication mode of each port.

Argument:

<port range> : syntax 1,5-7, available from 1 to 24

<mode>: set up 802.1X mode

0:disable the 802.1X function

1:set 802.1X to Multi-host mode

Possible value:

<port range> : 1 to 24

<mode>: 0 or 1

Example:

```
GEFXL2P-SW24(802.1X)# set mode 2 1
```

```
GEFXL2P-SW24(802.1X)#
```

set port-control

Syntax:

set port-control <port-range> <unauthorized| authorized| auto>

Description:

To set up 802.1X status of each port.

Argument:

<port range> : syntax 1,5-7, available from 1 to 24

<authorized> : Set up the status of each port

0:ForceUnauthorized

1:ForceAuthorized

2:Auto

Possible value:

<port range> : 1 to 24

<authorized> : 0, 1 or 2

Example:

```
GEFXL2P-SW24(802.1X)# set port-control 2 2
```

set quietPeriod

Syntax:

set quietPeriod <port-range> <value>

Description:

A timer used by the Authenticator state machine to define periods of time during when it will not attempt to acquire a Supplicant.

Argument:

<port range> : syntax 1,5-7, available from 1 to 24

<value> : timer , range 0-65535

Possible value:

<port range> : 1 to 24

<value> : 0-65535, default is 60

Example:

```
GEFXL2P-SW24(802.1X)# set quietPeriod 2 30
```

set reAuthEnabled

Syntax:

set reAuthEnabled <port-range> <on | off >

Description:

A constant that define whether regular reauthentication will take place on this port.

Argument:

<port range> : syntax 1,5-7, available from 1 to 24

<on | off > :

0:OFF Disable reauthentication

1:ON Enable reauthentication

Possible value:

<port range> : 1 to 24

< on | off | > : 0 or 1, default is 1

Example:

```
GEFXL2P-SW24(802.1X)# set reAuthEnabled 2 1
```

set reAuthMax

Syntax:

set reAuthMax <port-range> <value>

Description:

The number of reauthentication attempts that are permitted before the port becomes Unauthorized.

Argument:

<port range> : syntax 1,5-7, available from 1 to 24

<value> : max. value , range 1-10

Possible value:

<port range> : 1 to 24

<value> : 1-10, default is 2

Example:

```
GEFXL2P-SW24(802.1X)# set reAuthMax 2 2
```

set reAuthPeriod

Syntax:

set reAuthPeriod <port-range> <value>

Description:

A constant that defines a nonzero number of seconds between periodic reauthentication of the supplicant.

Argument:

<port range> : syntax 1,5-7, available from 1 to 24

<value> : timer , range 1-65535

Possible value:

<port range> : 1 to 24

<value> : 1-65535, default is 3600

Example:

```
GEFXL2P-SW24(802.1X)# set reAuthPeriod 2 3600
```

set serverTimeout

Syntax:

set serverTimeout <port-range> <value>

Description:

A timer used by the Backend Authentication state machine in order to determine timeout conditions in the exchanges between the Authenticator and the Supplicant or Authentication Server. The initial value of this timer is either suppTimeout or serverTimeout, as determined by the operation of the Backend Authentication state machine.

Argument:

<port range> : syntax 1,5-7, available from 1 to 24

<value> : timer , range 1-65535

Possible value:

<port range> : 1 to 24

<value> : 1-65535, default is 30

Example:

```
GEFXL2P-SW24(802.1X)# set serverTimeout 2 30
```

set auth-server

Syntax:

set auth-server <ip-address> <udp-port> <secret-key>

Description:

To configure the settings related with 802.1X Radius Server.

Argument:

<ip-address> : the IP address of Radius Server

<udp-port> : the service port of Radius Server(Authorization port)

<secret-key> : set up the value of secret-key, and the length of secret-key is from 1 to 31

Possible value:

<udp-port > : 1~65535, default is 1812

Example:

```
GEFXL2P-SW24(802.1X)# set auth-server 192.168.1.115 1812 WinRadius
```

set suppTimeout

Syntax:

set suppTimeout <port-range> <value>

Description:

A timer used by the Backend Authentication state machine in order to determine timeout conditions in the exchanges between the Authenticator and the Supplicant or Authentication Server. The initial value of this timer is either suppTimeout or serverTimeout, as determined by the operation of the Backend Authentication state machine.

Argument:

<port range> : syntax 1,5-7, available from 1 to 24

<value> : timer , range 1-65535

Possible value:

<port range> : 1 to 24

<value> : 1-65535, default is 30

Example:

```
GEFXL2P-SW24(802.1X)# set suppTimeout 2 30
```

set txPeriod

Syntax:

set txPeriod <port-range> <value>

Description:

A timer used by the Authenticator PAE state machine to determine when an EAPOL PDU is to be transmitted

Argument:

<port range> : syntax 1,5-7, available from 1 to 24

<value> : timer , range 1-65535

Possible value:

<port range> : 1 to 24

<value> : 1-65535, default is 30

Example:

```
GEFXL2P-SW24(802.1X)# set txPeriod 2 30
```

show status

Syntax:

show status

Description:

To display the mode of each port.

Argument:

None

Possible value:

None

Example:

```
GEFXL2P-SW24(802.1X)# show status
```

```
Port      Mode
=====  =====
1         Disable
2         Multi-host
3         Disable
4         Disable
5         Disable
6         Disable
```

show port-config

Syntax:

show port-config <port-range>

Description:

To display the parameter settings of each port.

Argument:

<port range> : syntax 1,5-7, available from 1 to 24

Possible value:

<port range> : 1 to 24

Example:

```
GEFXL2P-SW24(802.1X)# show port-config 1, 2
```

```
port 1) Mode          : Disabled
```

```
port control : Auto
```

```
    reAuthMax      : 2
    txPeriod       : 30
    Quiet Period   : 60
    reAuthEnabled  : ON
    reAuthPeriod   : 120
    max. Request   : 2
    suppTimeout    : 30
    serverTimeout  : 30
```

```
port 2) Mode          : Disabled
```

```
port control : Auto
```

```
    reAuthMax      : 2
    txPeriod       : 30
    Quiet Period   : 60
```

```
reAuthEnabled : ON
reAuthPeriod  : 120
max. Request   : 2
suppTimeout    : 30
serverTimeout  : 30
```

show statistics

Syntax:

show statistics <#>

Description:

To display the statistics of each port.

Argument:

<#> syntax 1,5-7, available from 1 to 24

Possible value:

<#> 1 to 24

:

show server

Syntax:

show server

Description:

Show the Radius server configuration

Argument:

None

Possible value:

None

Example:

```
GEFXL2P-SW24(802.1X)# show server
Authentication Server
```

```
IP Address: 192.168.1.1
UDP Port   : 1812
Secret Key  : Radius
```

Accounting Server

```
IP Address: 192.168.1.1
UDP Port   : 1812
Secret Key  : Radius
```

■ account

add

Syntax:

add <name>

Description:

To create a new guest user. When you create a new guest user, you must type in password and confirm password.

Argument:

<name> : new account name

Possible value:

A string must be at least 5 character.

Example:

```
GEFXL2P-SW24(account)# add aaaaa
```

Password:

Confirm Password:

```
GEFXL2P-SW24(account)#
```

del**Syntax:**

```
del <name>
```

Description:

To delete an existing account.

Argument:

<name> : existing user account

Possible value:

None.

Example:

```
GEFXL2P-SW24(account)# del aaaaa
```

Account aaaaa deleted

modify**Syntax:**

```
modify <username>
```

Description:

To change the username and password of an existing account.

Argument:

<name> : existing user account

Possible value:

None.

Example:

```
GEFXL2P-SW24(account)# modify aaaaa
```

username/password: the length is from 5 to 15.

Current username (aaaaa):bbbb

New password:

Confirm password:

Username changed successfully.

Password changed successfully.

show**Syntax:**

```
show
```

Description:

To show system account, including account name and identity.

Argument:

None.

Possible value:

None.

Example:

```
GEFXL2P-SW24(account)# show
```

Account Name	Identity
admin	Administrator
guest	guest

■ acl

ace

Syntax:

```
ace <index>
```

Description:

To display the ace configuration.

Argument:

<index> : the access control rule index value

Possible value:

None.

Example:

```
GEFXL2P-SW24(acl)# ace 2
```

```
index: 2
rule: switch
vid: any
tag_prio: any
dmac: any
frame type: arp
arp type: Request/Reply (opcode): any
source ip: any
destination ip: any
ARP flag
ARP SMAC Match: any
RARP DMAC Match: any
IP/Ethernet Length: any
IP: any
Ethernet: any
action: 1
rate limiter: 0
copy port: 0
```

action

Syntax:

action <port> <permit|deny> <rate_limiter> <port copy>

Description:

To set the access control per port as packet filter action rule.

Argument:

<port> : 1-24

<permit/deny>: permit: 1, deny: 0

<rate_limiter>: 0-16 (0:disable)

<port copy> : 0-24 (0:disable)

Possible value:

<port> : 1-24

<permit/deny>: 0-1

<rate_limiter>: 0-16

<port copy> : 0-24

Example:

```
GEFXL2P-SW24(acl)# action 5 0 2 2
```

```
GEFXL2P-SW24(acl)# show
```

```
port policy id  action  rate limiter port copy  counter a class map
..      ..      .....
5       1       deny      2         2         0
23      1       permit    0         0         0
24      1       permit    0         0         0
```

```
rate limiter  rate(pps)
-----
```

```
1           1
2           1
3           1
4           1
5           1
```

```
.....
```

```
GEFXL2P-SW24(acl)#
```

delete

Syntax:

delete <index>

Description:

To delete the ACE (Access Control Entry) configuration on the switch.

Argument:

<index> : the access control rule index value

Possible value:

None.

Example:

```
GEFXL2P-SW24(acl)# delete 1
```

```
GEFXL2P-SW24(acl)#
```

move

Syntax:

move <index1> <index2>

Description:

To move the ACE (Access Control Entry) configuration between index1 and index2..

Argument:

None.

Possible value:

None.

Example:

```
GEFXL2P-SW24(account)# move 1 2
```

policy

Syntax:

policy <policy> <ports>

Description:

To set acl port policy on switch

Argument:

<policy> : 1-8

<ports> : 1-24

Possible value:

<policy> : 1-8

<ports> : 1-24

Example:

```
GEFXL2P-SW24(acl)# policy 3 10
```

```
GEFXL2P-SW24(acl)#
```

ratelimiter

Syntax:

ratelimiter <id> <rate>

Description:

To set access control rule with rate limiter on switch

Argument:

<id> : 1-16

<rate> : 1,2,4,8,16,32,64,128,256,512,1000,2000, 4000,8000,
16000,32000,64000,128000,256000,512000,1024000

Possible value:

<id> : 1-16

<rate> : 1,2,4,8,16,32,64,128,256,512,1000,2000, 4000,8000,
16000,32000,64000,128000,256000,512000,1024000

Example:

```
GEFXL2P-SW24(acl)# ratelimiter 3 16000
```

```
GEFXL2P-SW24(acl)#
```

set

Syntax:

```
set [<index>] [<next index>]
    [switch | (port <port>) | (policy <policy>)]
    [<vid>] [<tag_prio>] [<dmac_type>]
    [(any) |
    (etype [<etype>] [<smac>]) |
    (arp [<arp type>] [<opcode>]
        (any | [<source ip>] [<source ip mask>])
        (any | [<destination ip>] [<destination ip mask>])
        [<source mac>] [<arp smac match flag>]
        [<raro dmac match flag>] [<ip/ethernet length flag>]
        [<ip flag>] [<ethernet flag>]) |
    (ip [(<source ip> <source ip mask>) | any]
        [(<destination ip> <destination ip mask>) | any]
        [<ip ttl>] [<ip fragment>] [<ip option>]
        [(icmp <icmp type> <icmp code>) |
        (udp <source port range> <destination port range>) |
        (tcp <source port range> <destination port range>
            <tcp fin flag> <tcp syn flag> <tcp rst flag>
            <tcp psh flag> <tcp ack flag> <tcp urg flag>) |
        (other <ip protocol value>) |
        (any)]
    ]
    [<action>] [<rate limiter>] [<port copy>]
```

Description:

To set access control entry on switch

Argument:

Possible value:

Example:

show

Syntax:

```
show
```

Description:

To show all access control entry setting on switch

Argument:

none

Possible value:

none

Example:

```
GEFXL2P-SW24(acl)# show
port policy id action rate limiter port copy counter a class map
.. .. ..... ..
5 1 deny 2 2
23 1 permit 0 0 0
24 1 permit 0 0 0
```

rate limiter	rate(pps)
1	1
2	1
3	1
4	1
5	1
.....

GEFXL2P-SW24(ac1)#

■ alarm

<<email>>

del mail-address

Syntax:

del mail-address <#>

Description:

To remove the configuration of E-mail address.

Argument:

<#>: email address number, range: 1 to 6

Possible value:

<#>: 1 to 6

Example:

GEFXL2P-SW24(alarm-email)# del mail-address 2

del server-user

Syntax:

del server-user

Description:

To remove the configuration of server, user account and password.

Argument:

None.

Possible value:

None.

Example:

GEFXL2P-SW24(alarm-email)# del server-user

set mail-address

Syntax:

set mail-address <#> <mail address>

Description:

To set up the email address.

Argument:

<#> :email address number, range: 1 to 6

<mail address>:email address

Possible value:

<#>: 1 to 6

Example:

```
GEFXL2P-SW24(alarm-email)# set mail-address 1 abc@mail.abc.com
```

set server**Syntax:**

```
set server <ip>
```

Description:

To set up the IP address of the email server.

Argument:

<ip>:email server ip address or domain name

Possible value:

None.

Example:

```
GEFXL2P-SW24(alarm-email)# set server 192.168.1.6
```

set user**Syntax:**

```
set user <username>
```

Description:

To set up the account and password of the email server.

Argument:

<username>: email server account and password

Possible value:

None.

Example:

```
GEFXL2P-SW24 (alarm-email)# set user admin
```

show**Syntax:**

```
show
```

Description:

To display the configuration of e-mail.

Argument:

None.

Possible value:

None.

Example:

```
GEFXL2P-SW24(alarm-email)# show
Mail Server      : 192.168.1.6
Username         : admin
Password        : *****
```

Email Address 1: abc@mail.abc.com
Email Address 2:
Email Address 3:
Email Address 4:
Email Address 5:
Email Address 6:

<<events>>

del all

Syntax:

del all <range>

Description:

To disable email and trap of events.

Argument:

<range>:del the range of events, syntax 1,5-7

Possible value:

<range>: 1~24

Example:

GEFXL2P-SW24(alarm-events)# del all 1-3

del email

Syntax:

del email <range>

Description:

To disable the email of the events.

Argument:

<range>:del the range of email, syntax 1,5-7

Possible value:

<range>: 1~24

Example:

GEFXL2P-SW24(alarm-events)# del email 1-3

del trap

Syntax:

del trap <range>

Description:

To disable the trap of the events.

Argument:

<range>:del the range of trap, syntax 1,5-7

Possible value:

<range>: 1~24

Example:

GEFXL2P-SW24(alarm-events)# del trap 1-3

set all

Syntax:

set all <range>

Description:

To enable email and trap of events.

Argument:

<range>:set the range of events, syntax 1,5-7

Possible value:

<range>: 1~24

Example:

```
GEFXL2P-SW24(alarm-events)# set all 1-3
```

set email

Syntax:

set email <range>

Description:

To enable the email of the events.

Argument:

<range>:set the range of email, syntax 1,5-7

Possible value:

<range>: 1~24

Example:

```
GEFXL2P-SW24(alarm-events)# set email 1-3
```

set trap

Syntax:

set trap <range>

Description:

To enable the trap of the events.

Argument:

<range>:set the range of trap, syntax 1,5-7

Possible value:

<range>: 1~24

Example:

```
GEFXL2P-SW24(alarm-events)# set trap 1-3
```

show

Syntax:

show

Description:

To display the configuration of alarm event.

Argument:

None.

Possible value:

None.

Example:

```
GEFXL2P-SW24(alarm-events)# show
  Events                               Email  Trap
-----
 1 Cold Start                          v
 2 Warm Start                          v
 3 Link Down                           v
 4 Link Up                             v
 5 Authentication Failure               v
 6 Login
 7 Logout
 8 Module Inserted
 9 Module Removed
10 Dual Media Swapped
11 Looping Detected
12 STP Disabled
13 STP Enabled
14 STP Topology Changed
15 LACP Disabled
16 LACP Enabled
17 LACP Member Added
18 LACP Aggregates Port Failure
19 GVRP Disabled
20 GVRP Enabled
21 VLAN Disabled
22 Port-based Vlan Enabled
23 Tag-based Vlan Enabled
24 IP MAC Binding Enabled
25 IP MAC Binding Disabled
26 IP MAC Binding Client Authenticate error
27 IP MAC Binding Server Authenticate error
```

show (alarm)

Syntax:

show

Description:

The Show for alarm here is used to display the configuration of Events, or E-mail.

Argument:

None.

Possible value:

None.

Example:

```
GEFXL2P-SW24(alarm)# show events
```

```
GEFXL2P-SW24(alarm)# show email
```

■ **autologout**

autologout

Syntax:

autologout <time>

Description:

To set up the timer of autologout.

Argument:

<time>: range 1 to 3600 seconds, 0 for autologout off, current setting is 180 seconds.

Possible value:

<time>: 0,1-3600

Example:

```
GEFXL2P-SW24# autologout 3600
```

Set autologout time to 3600 seconds

■ config-file

export

Syntax:

export <current | user> < ip address>

Description:

To run the export function.

Argument:

< Usage> set up current or user

< ip address> the TFTP server ip address

Possible value:

none

Example:

GEFXL2P-SW24(config-file)# export current 192.168.1. 63

Export successful.

import

Syntax:

import <current | user> < ip address>

Description:

To run the import start function.

Argument:

None

Possible value:

None

Example:

GEFXL2P-SW24(config-file)# import current 192.168.1.63

Import successful.

■ firmware

Upgrade

Syntax:

upgrade <ip_address> <file_path>

Description:

To set up the image file that will be upgraded.

Argument:

< ip address> : TFTP server ip address

<filepath>: upgrade file path

Possible value:

< ip address> : TFTP server ip address

<filepath>: upgrade file path

Example:

GEFXL2P-SW24(firmware)# upgrade 192.168.2.4 rpg0916ip_v2.03.img

■ gvrp

set state

Syntax:

set state < 0 | 1>

Description:

To disable/ enable the gvrp function.

Argument:

0 : disable the gvrp function

1 : enable the gvrp function

Possible value:

0 : disable the gvrp function

1 : enable the gvrp function

Example:

```
GEFXL2P-SW24(gvrp)# set state 1
```

group applicant

Syntax:

group applicant <vid> <port> < 0 | 1>

Description:

To enter any of gvrp group for changing gvrp group setting. You can change the applicant or registrar mode of existing gvrp group per port.

Argument:

<vid>: enter which gvrp group you had created, using value is vid. Available range:

1 to 4094

<port>: 1 to 24

< 0 | 1> :

Possible value:

<vid>: 1~4094

<port>: 1 to 24

Example:

```
GEFXL2P-SW24(gvrp)# group applicant 2 5 0
```

GVRP group information

Current Dynamic Group Number: 1

```
VID  Member Port
```

```
2    5
```

set applicant

Syntax:

set applicant <port> < 0 | 1 >

Description:

To set default applicant mode for each port.

Argument:

<port>: port range, syntax 1,5-7, available from 1 to 24

<0>: set applicant as normal mode

<1>: set applicant as non-participant mode

Possible value:

<port>: 1 to 24

< 0 | 1 >: normal or non-participant

Example:

```
GEFXL2P-SW24(gvrp)# set applicant 1-10 non-participant
```

set registrar

Syntax:

set registrar <port> < 0 | 1 | 2>

Description:

To set default registrar mode for each port.

Argument:

<port>: port range, syntax 1,5-7, available from 1 to 24

<0>: set registrar as normal mode

<1>: set registrar as fixed mode

<2>: set registrar as forbidden mode

Possible value:

<range>: 1 to 24

< 0 | 1 | 2>: normal or fixed or forbidden

Example:

```
GEFXL2P-SW24(gvrp)# set registrar 1-5 fixed
```

set restricted

Syntax:

set restricted <port> <0 | 1 | 2>

Description:

To set the restricted mode for each port.

Argument:

<port>: port range, syntax 1,5-7, available from 1 to 24

<0>: set restricted normal

<1>: set restricted fixed

<2>: set restricted forbidden

Possible value:

<port>: 1 to 24

< 0 | 1 | 2>: normal, fixed or forbidden

Example:

```
GEFXL2P-SW24(gvrp)# set restricted 1-10 1
```

```
GEFXL2P-SW24(gvrp)# show config
```

GVRP state: Enable

Port	Join Time	Leave Time	LeaveAll Time	Applicant	Registrar	Restricted
1	20	60	1000	Normal	Normal	Enable
2	20	60	1000	Normal	Normal	Enable
3	20	60	1000	Normal	Normal	Enable
4	20	60	1000	Normal	Normal	Enable
5	20	60	1000	Normal	Normal	Enable
6	20	60	1000	Normal	Normal	Enable
7	20	60	1000	Normal	Normal	Enable
8	20	60	1000	Normal	Normal	Enable
9	20	60	1000	Normal	Normal	Enable
10	20	60	1000	Normal	Normal	Enable
				:		
				:		
				:		
22	20	60	1000	Normal	Normal	Disable
23	20	60	1000	Normal	Normal	Disable
24	20	60	1000	Normal	Normal	Disable

set timer

Syntax:

set timer <port> <JoinTime> <leaveTime> <leaveAllTime>

Description:

To set gvrp join time, leave time, and leaveall time for each port.

Argument:

<port> : port range, syntax 1,5-7, available from 1 to 24

<JoinTimes>: join timer, available from 20 to 100

<LeaveTime>: leave timer, available from 60 to 300

<LeaveAllTime>: leaveall timer, available from 1000 to 5000

Leave Time must equal double Join Time at least.

Possible value:

<port> : 1 to 24

<JoinTimes>: 20 to 100

<LeaveTime>: 60 to 300

<LeaveAllTime>: 1000 to 5000

Example:

```
GEFXL2P-SW24(gvrp)# set timer 2-8 25 80 2000
```

show

Syntax:

show

Description:

To display the gvrp configuration.

Argument:

None

Possible value:

None

Example:

```
GEFXL2P-SW24(gvrp)# show
```

GVRP state: Enable

Port	Join Time	Leave Time	LeaveAll Time	Applicant	Registrar	Restricted
1	20	60	1000	Normal	Normal	Disable
2	25	80	2000	Normal	Normal	Disable
3	25	80	2000	Normal	Normal	Disable
4	25	80	2000	Normal	Normal	Disable
5	25	80	2000	Normal	Normal	Disable
6	25	80	2000	Normal	Normal	Disable
7	25	80	2000	Normal	Normal	Disable
8	25	80	2000	Normal	Normal	Disable
				:		
				:		
23	20	60	1000	Normal	Normal	Disable
24	20	60	1000	Normal	Normal	Disable

counter

Syntax:

counter <port>

Description:

To display the counter number of the port.

Argument:

<port>: port number

Possible value:

<port>: available from 1 to 24

Example:

```
GEFXL2P-SW24(gvrp)# counter 2
```

Received

```
Total GVRP Packets      : 0
Invalid GVRP Packets    : 0
LeaveAll message         : 0
JoinEmpty message       : 0
JoinIn message          : 0
LeaveEmpty message       : 0
Empty message           : 0
```

```
Transmitted
Total GVRP Packets      : 0
Invalid GVRP Packets    : 0
LeaveAll message         : 0
JoinEmpty message       : 0
JoinIn message          : 0
LeaveEmpty message       : 0
Empty message           : 0
```

group grpinfo

Syntax:

group grpinfo <vid>

Description:

To show the gvrp group.

Argument:

<vid>: To set the vlan id from 1 to 4094

Possible value:

<vid>: 1 to 4094

Example:

```
GEFXL2P-SW24(gvrp)# group grpinfo 2
GVRP group information
VID Member Port
```

■ **hostname**

hostname

Syntax:

hostname <name>

Description:

To set up the hostname of the switch.

Argument:

<name>: hostname, max. 40 characters.

Possible value:

<name>: hostname, max. 40 characters.

Example:

```
GEFXL2P-SW24# hostname Company
```

```
Company#
```

■ **igmp**

set drp

Syntax:

set drp <port >

Description:

Set router ports to disable.

Argument:

<port >: syntax 1,5-7, available from 1 to 24

Possible value:

<port >: 1 to 24

Example:

```
GEFXL2P-SW24(igmp)# set drp 1-10
```

set erp

Syntax:

set erp <port>

Description:

Set router ports to enable

Argument:

<port>: syntax 1,5-7, available from 1 to 24

Possible value:

<port>: 1 to 24

Example:

```
GEFXL2P-SW24(igmp)# set erp 1
```

set flood

Syntax:

set flood <state>

Description:

To set up disable / enable unregister ipmc flooding.

Argument:

<state>: 0:disable, 1:enable

Possible value:

<state>: 0, or 1

Example:

```
GEFXL2P-SW24(igmp)# set flood 1
```

show gm

Syntax:

show gm

Description:

To display group membership.

Argument:

None.

Possible value:

None.

Example:

```
GEFXL2P-SW24(igmp)# show gm
```

show igmpp

Syntax:

show igmpp

Description:

To display igmp proxy setting

Argument:

None.

Possible value:

None.

Example:

```
GEFXL2P-SW24(igmp)# show igmpp
```

■ IP

disable dhcp

Syntax:

```
disable dhcp
```

Description:

To disable the DHCP function of the system.

Argument:

None

Possible value:

None

Example:

```
GEFXL2P-SW24(ip)# disable dhcp
```

enable dhcp

Syntax:

```
enable dhcp <manual|auto>
```

Description:

To enable the system DHCP function and set DNS server via manual or auto mode.

Argument:

<manual|auto> : set dhcp by using manual or auto mode.

Possible value:

<manual|auto> : manual or auto

Example:

```
GEFXL2P-SW24(ip)# enable dhcp manual
```

set dns

Syntax:

```
set dns <ip>
```

Description:

To set the IP address of DNS server.

Argument:

<ip> : dns ip address

Possible value:

168.95.1.1

Example:

```
GEFXL2P-SW24 (ip)# set dns 168.95.1.1
```

set ip

Syntax:

set ip <ip> <mask> <gateway>

Description:

To set the system IP address, subnet mask and gateway.

Argument:

<ip> : ip address

<mask> : subnet mask

<gateway> : default gateway

Possible value:

<ip> : 192.168.1.2 or others

<mask> : 255.255.255.0 or others

<gateway> : 192.168.1.253 or others

Example:

```
GEFXL2P-SW24(ip)# set ip 192.168.1.2 255.255.255.0 192.168.1.253
```

show

Syntax:

show

Description:

To display the system's DHCP function state, IP address, subnet mask, default gateway, DNS mode, DNS server IP address and current IP address.

Argument:

None

Possible value:

None

Example:

```
GEFXL2P-SW24(ip)# show
```

```
DHCP                : Disable
IP Address          : 192.168.2.237
Current IP Address  : 192.168.2.237
Subnet mask         : 255.255.255.0
Gateway             : 192.168.2.252
DNS Setting         : Manual
DNS Server          : 168.95.1.1
```

■ ip_mac_binding

set entry

Syntax:

set entry < 0 | 1> < mac> < ip> < port no> < vid>

Description:

To set ip mac binding entry

Argument:

< 0 | 1> : 0 : Client , 1: Server

<mac> : mac address

< ip > : ip address

< port > : syntax 1,5-7, available from 1 to 24

< vid > : vlan id, 1 to 4094

Possible value:

< 0 | 1> : 0 : Client , 1: Server

<mac> : format: 00-02-03-04-05-06

< ip > : ip address

< port > : 1 to 24

< vid > : 1 to 4094

Example:

```
GEFXL2P-SW24(ip_mac_binding)# set entry 1 00-11-2f-de-7b-a9 192.168.2.2 1
1
```

delete ip

Syntax:

delete ip < 0 | 1> <ip>

Description:

Delete ip mac binding entry by ip.

Argument:

<0 | 1> : 0 : client, 1: server

<ip> : ip address

Possible value:

None

Example:

```
GEFXL2P-SW24(ip_mac_binding)# delete ip 1 192.168.2.2
```

set state

Syntax:

show

Description:

To display the mac alias entry.

Argument:

None

Possible value:

None

Example:

```
GEFXL2P-SW24(mac-table-alias)# show
MAC Alias List
```

	MAC Address	Alias
1)	00-02-03-04-05-06	aaa
2)	00-33-03-04-05-06	ccc
3)	00-44-33-44-55-44	www

■ loop-detection***disable*****Syntax:**

```
disable <#>
```

Description:

To disable switch ports the loop detection function.

Argument:

<#> : set up the range of the ports to search for, syntax 1,5-7, available form 1 to 24

Possible value:

<#> :1 to 24

Example:

```
GEFXL2P-SW24(loop-detection)# disable 1-24
```

```
GEFXL2P-SW24(loop-detection)# show
```

Detection Port	Port Status	Locked Port	Port Status
1	Disable	1	Normal
2	Disable	2	Normal
3	Disable	3	Normal
4	Disable	4	Normal
5	Disable	5	Normal
6	Disable	6	Normal
7	Disable	7	Normal
8	Disable	8	Normal
.....			

enable**Syntax:**

```
enable <#>
```

Description:

To enable switch ports the loop detection function.

Argument:

<#> : set up the range of the ports to search for, syntax 1,5-7, available form 1 to 24

Possible value:

<#> :1 to 24

Example:

```
GEFXL2P-SW24(loop-detection)# enable 1-24
```

```
GEFXL2P-SW24(loop-detection)# show
```

Detection Port		Locked Port	
Port	Status	Port	Status
1	Enable	1	Normal
2	Enable	2	Normal
3	Enable	3	Normal
4	Enable	4	Normal
5	Enable	5	Normal
6	Enable	6	Normal
7	Enable	7	Normal
8	Enable	8	Normal
.....			

Resume

Syntax:

resume <#>

Description:

To resume locked ports on switch.

Argument:

<#> : set up the range of the ports to search for, syntax 1,5-7, available form 1 to 24

Possible value:

<#> :1 to 24

Example:

```
GEFXL2P-SW24 (loop-detection)# resume 1-24
```

```
GEFXL2P-SW24 (loop-detection)# show
```

Detection Port		Locked Port	
Port	Status	Port	Status
1	Enable	1	Normal
2	Enable	2	Normal
3	Enable	3	Normal
4	Enable	4	Normal
5	Enable	5	Normal
6	Enable	6	Normal
7	Enable	7	Normal
8	Enable	8	Normal
.....			

Resume

Syntax:

resume <#>

Description:

To resume locked ports on switch.

Argument:

<#> : set up the range of the ports to search for, syntax 1,5-7, available form 1 to 24

Possible value:

<#> :1 to 24

Example:

```
GEFXL2P-SW24 (loop-detection)# resume 1-24
```

```
GEFXL2P-SW24 (loop-detection)# show
```

Detection Port		Locked Port	
Port	Status	Port	Status
1	Enable	1	Normal
2	Enable	2	Normal
3	Enable	3	Normal
4	Enable	4	Normal
5	Enable	5	Normal
6	Enable	6	Normal
7	Enable	7	Normal
8	Enable	8	Normal
.....			

show

Syntax:

show

Description:

To display loop detection configure.

Argument:

None

Possible value:

None

Example:

```
GEFXL2P-SW24 (loop-detection)# show
```

Detection Port		Locked Port	
Port	Status	Port	Status
1	Enable	1	Normal
2	Enable	2	Normal
3	Enable	3	Normal
4	Enable	4	Normal
5	Enable	5	Normal
6	Enable	6	Normal
7	Enable	7	Normal
8	Enable	8	Normal
.....			

■ **Mac**

<<*alias*>>

del

Syntax:

del <mac>

Description:

To del mac alias entry.

Argument:

<mac> : set up the MAC format: xx-xx-xx-xx-xx-xx

Possible value:

<mac> : set up the MAC format: xx-xx-xx-xx-xx-xx

Example:

```
GEFXL2P-SW24(mac-alias)# set 23-56-r5-55-3f-03 test3
```

```
GEFXL2P-SW24(mac-alias)# show
```

MAC Alias

No	MAC	Alias
1	23-56-00-55-3F-03	test3
2	23-56-00-55-EF-03	test13
3	23-56-00-55-EF-33	test1

```
GEFXL2P-SW24(mac-alias)# del 23-56-00-55-3F-03
```

```
GEFXL2P-SW24(mac-alias)# show
```

MAC Alias

No	MAC	Alias
1	23-56-00-55-EF-03	test13
2	23-56-00-55-EF-33	test1

set

Syntax:

set <mac> < alias>

Description:

To set mac alias entry.

Argument:

<mac> : mac address, xx-xx-xx-xx-xx-xx

<alias> : mac alias name, max 15 characters

Possible value:

<mac> : set up the MAC format: xx-xx-xx-xx-xx-xx

<alias> : mac alias name, max 15 characters

Example:

```
GEFXL2P-SW24(mac-alias)# set 23-56-r5-55-3f-03 test3
```

```
GEFXL2P-SW24(mac-alias)# show
```

MAC Alias

No	MAC	Alias
1	23-56-00-55-3F-03	test3
2	23-56-00-55-EF-03	test13
3	23-56-00-55-EF-33	test1

show

Syntax:

show

Description:

To display mac alias entry.

Argument:

None

Possible value:

none

Example:

```
GEFXL2P-SW24(mac-alias)# show
```

```
MAC Alias
```

No	MAC	Alias
1	23-56-00-55-3F-03	test3
2	23-56-00-55-EF-03	test13
3	23-56-00-55-EF-33	test1

<<mac-table>>

flush

Syntax:

flush

Description:

To del dynamic mac entry.

Argument:

none

Possible value:

none

Example:

```
GEFXL2P-SW24(mac-mac-table)# flush
```

```
GEFXL2P-SW24(mac-mac-table)# show
```

No	Type	VLAN	MAC	Port Members
1	Static	1	FF-FF-FF-FF-FF-FF	1, 2, 3, 4, 5, 6, 7, 8, 9, 10, 11, 12, 13, 14, 15, 16, 17, 18, 19, 20, 21, 22, 23, 24,

show

Syntax:

show

Description:

To show all mac table informaion.

Argument:

none

Possible value:

none

Example:

```
GEFXL2P-SW24(mac-mac-table)# show
```

No	Type	VLAN	MAC	Port Members
1	Static	1	FF-FF-FF-FF-FF-FF	1, 2, 3, 4, 5, 6, 7, 8, 9, 10, 11, 12, 13, 14, 15, 16, 17, 18, 19, 20, 21, 22, 23, 24,

<<maintenance>>

set age-time

Syntax:

```
set age-time <#>
```

Description:

To set mac table age out time of dynamic learning mac.

Argument:

<#>: age-timer in seconds, 0, 10 1000000. The value zero disables aging

Possible value:

<#>: 0, 10 to 1000000.

Example:

```
GEFXL2P-SW24(mac-table-maintain)# set age-time 300
```

```
GEFXL2P-SW24(mac-maintenance)# show
```

```
E api_ai 26/vtss_
```

Aging Configuration: Enter into sta

Age time: 300mode

MAC Table Learning

```
Port Learning Mode-<< Global commands >
```

2	Auto
3	Auto
4	Auto
5	Auto
6	Auto
7	Auto
8	Auto
9	Auto
10	Auto
11	Auto
12	Auto
13	Auto
14	Auto
15	Auto
16	Auto
17	Auto
18	Auto

19 Auto
20 Auto
21 Auto
22 Auto
23 Auto
24 Auto

set learning

Syntax:

set learning <range> <auto|disable|secure>

Description:

To set mac table learning.

Argument:

<range syntax> : 1,5-7, available from 1 to 24

<auto >: auto learning

<disable >: disable learning

<secure >: learn frames are discarded

Possible value:

<range syntax> : 1,5-7, available from 1 to 24

<auto >: auto learning

<disable >: disable learning

<secure >: learn frames are discarded.

Example:

```
GEFXL2P-SW24(mac-table-maintain)# set learning 1-24 auto
```

```
GEFXL2P-SW24(mac-maintenance)# show
```

```
E api_ai 26/vtss_
```

```
Aging Configuration:      Enter into sta
```

```
Age time: 300mode
```

MAC Table Learning

```
Port    Learning Mode-<< Global commands >
```

```
2       Auto  
3       Auto  
4       Auto  
5       Auto  
6       Auto  
7       Auto  
8       Auto  
9       Auto  
10      Auto  
11      Auto  
12      Auto  
13      Auto  
14      Auto  
15      Auto  
16      Auto  
17      Auto
```

18	Auto
19	Auto
20	Auto
21	Auto
22	Auto
23	Auto
24	Auto

show

Syntax:

show

Description:

To display mac table maintenance

Argument:

Noneq

Possible value:

None

Example:

```
GEFXL2P-SW24(mac-maintenance)# show
  1 Static
```

Aging Configuration:FF 1, 2, 3, 4, 5, 6, 7, 8, 9

Age time: 3004, 15, 16, 17, 1

MAC Table Learning

Port	Learning Mode
2	Auto
3	Auto
4	Auto
5	Auto
6	Auto
7	Auto
8	Auto
9	Auto
10	Auto
11	Auto
12	Auto
13	Auto
14	Auto
15	Auto
16	Auto
17	Auto
18	Auto
19	Auto
20	Auto
21	Auto
22	Auto
23	Auto

<<static-mac>>

add

Syntax:

add <mac> <port> <vid> [alias]

Description:

To add the static mac entry.

Argument:

<mac> : mac address, format: 00-02-03-04-05-06

<port> : 0-24. The value "0" means this entry is filtering entry

<vid> : vlan id. 0, 1-4094. VID must be zero if vlan mode is not tag-based

[alias] : mac alias name, max. 15 characters

Possible value:

<mac> : mac address

<port> : 0-24

<vid> : 0, 1-4094

[alias] : mac alias name

Example:

```
GEFXL2P-SW24(mac-static-mac)# add 00-02-03-04-05-06 3 0 aaa
```

```
GEFXL2P-SW24(mac-static-mac)#
```

del

Syntax:

del <mac> <vid>

Description:

To del the static mac entry.

Argument:

<mac> : mac address, format: 00-02-03-04-05-06

<vid> : vlan id. 0, 1-4094. VID must be zero if vlan mode is not tag-based

Possible value:

<mac> : mac address

<vid> : 0, 1-4094

Example:

```
GEFXL2P-SW24(mac-static-mac)# del 00-02-03-04-05-06 0
```

```
GEFXL2P-SW24(mac-static-mac)#
```

show filter

Syntax:

show filter

Description:

To display the static filtering mac entry.

Argument:

None

Possible value:

None

Example:

```
GEFXL2P-SW24(mac-static-mac)# show filter
Static Filtering Etnry: (Total 1 item(s))
1) mac: 00-33-03-04-05-06, vid:    -, alias: ccc
GEFXL2P-SW24(mac-static-mac)#
```

show forward**Syntax:**

show forward

Description:

To display the static forwarding mac entry.

Argument:

None

Possible value:

None

Example:

```
GEFXL2P-SW24(mac-static-mac)# show forward
Static Forwarding Etnry: (Total 1 item(s))
1) mac: 00-02-03-04-05-06, port: 3, vid:    -, alias: aaa
GEFXL2P-SW24(mac-static-mac)#
```

■ mirror

set mirror

Syntax:

set mirror < #>

Description:

To set mirror port and enable/disable mirror function

Argument:

<#>: port, available from 1 to 24 and 0.

1 to 24: available port number

0: disable mirror function

Possible value:

<#>: 1 to 24

Example:

```
GEFXL2P-SW24(mirror)# set mirror 2
```

set monitor-destination

Syntax:

set monitor-destination <range>

Description:

To set monitor destination port. The packets sent by this port will be copied to the monitoring port.

Argument:

<range>: the port that is chosen for monitored port of the mirror function,

syntax 1,5-7, available from 1 to 24

Possible value:

<range>: 1 to 24

Example:

```
GEFXL2P-SW24(mirror)# set monitor-destination 2-15
```

```
GEFXL2P-SW24(mirror)# show
```

```
2          V
3          V
4          V
5          V
6          V
7          V
8          V
9          V
10         V
11         V
12         V
13         V
14         V
15         V
16
17
18
```

set monitor-source

Syntax:

set monitor-source <range>

Description:

To set up the monitoring port of the mirror function. User can observe the packets that the monitored port received via this port.

Argument:

<range>: the monitoring port that is chosen for the mirror function. Only one port is allowed to configure, available from 1 to 24

Possible value:

<range>:1 to 24

Example:

```
GEFXL2P-SW24(mirror)# set monitor-source 18
```

```
GEFXL2P-SW24(mirror)# show
```

Port to mirror to: 1

Port	Source Enable	Destination Enable
2		V
3		V
4		V
5		V
6		V
7		V
8		V
9		V
10		V
11		V
12		V
13		V
14		V
15		V
16		
17		
18	V	
19		
20		
21		
22		
23		
24		

```
GEFXL2P-SW24(mirror)#
```

show

Syntax:

show

Description:

To display the setting status of mirror configuration.

Argument:

None

Possible value:

None

Example:

```
GEFXL2P-SW24(mirror)# show
```

```
Port to mirror to: 1
```

Port	Source Enable	Destination Enable
2		V
3		V
4		V
5		V
6		V
7		V
8		V
9		V
10		V
11		V
12		V
13		V
14		V
15		V
16		
17		
18	V	
19		
20		
21		
22		
23		
24		

```
GEFXL2P-SW24(mirror)#
```

■ mstp

disable

Syntax:

disable

Description:

To disable mstp function.

Argument:

None

Possible value:

None

Example:

```
GEFXL2P-SW24 (mstp)# disable
```

enable

Syntax:

enable

Description:

To enable mstp function.

Argument:

None

Possible value:

None

Example:

```
GEFXL2P-SW24 (mstp)# enable
```

migrate-check

Syntax:

```
migrate-check <port-range>
```

Description:

To force the port to transmit RST BPDUs.

Argument:

Usage: migrate-check <port range>

port range syntax: 1,5-7, available from 1 to 24

Possible value:

Usage: migrate-check <port range>

port range syntax: 1,5-7, available from 1 to 24

Example:

```
GEFXL2P-SW24 (mstp)# migrate-check 1-2
```

set config

Syntax:

```
set config <Max Age><Forward Delay><Max Hops>
```

Description:

To set max age,forward delay,max hops.

Argument:

Publication date: Oct., 2009

Revision A6

<Max Age> : available from 6 to 40. Recommended value is 20
<Forward Delay(sec)> : available from 4 to 30. Recommended value is 15
<Max Hops> : available from 6 to 40. Recommended value is 20

Possible value:

<Max Age> : available from 6 to 40. Recommended value is 20
<Forward Delay(sec)> : available from 4 to 30. Recommended value is 15
<Max Hops> : available from 6 to 40. Recommended value is 20

Example:

```
GEFXL2P-SW24(mstp)# set config 20 15 20  
GEFXL2P-SW24(mstp)#
```

set msti-vlan

Syntax:

```
set msti-vlan <instance-id><vid-string>
```

Description:

To map Vlan ID(s) to an MSTI

Argument:

<instance-id> : MSTI id available from 1 to 4095

<vid-string> : syntax example: 2.5-7.100-200

Possible value:

<instance-id> : available from 1 to 4094

Example:

```
GEFXL2P-SW24(mstp)# set msti-vlan 2 2.5  
msti 2 had been successfully created and(or)  
vlan(s) have been added to map to this msti.  
GEFXL2P-SW24(mstp)#
```

set p-cost

Syntax:

```
set p-cost <instance_id> <port range> <path cost>
```

Description:

To set port path cost per instance

Argument:

<port range> syntax: 1,5-7, available from 1 to 24

<path cost> : 0, 1-200000000. The value zero means auto status

Possible value:

<port range> : available from 1 to 24

<path cost> : The value zero means auto status, 0-2000000000

Example:

```
GEFXL2P-SW24(mstp)# set p-cost 2 8-10 0  
GEFXL2P-SW24(mstp)#
```

set p-edge

Syntax:

```
set p-edge <port range> <admin edge>
```

Description:

To set per port admin edge

Argument:

<port range> syntax: 1,5-7, available from 1 to 24
<admin edge> : 0->non-edge port,1->edge ports

Possible value:

<port range> syntax: 1,5-7, available from 1 to 24
<admin edge> : 0->non-edge port,1->edge ports

Example:

```
GEFXL2P-SW24(mstp)# set p-edge 10-12 0  
GEFXL2P-SW24(mstp)#
```

set p-hello

Syntax:

```
set p-hello <port range> <hello time>
```

Description:

To set per port hello time

Argument:

<port range> : syntax: 1,5-7, available from 1 to 24
<hello time> : only 1~2 are valid values

Possible value:

<port range> : syntax: 1,5-7, available from 1 to 24
<hello time> : only 1~2 are valid values

Example:

```
GEFXL2P-SW24(mstp)# set p-hello 5-10 1  
GEFXL2P-SW24(mstp)#
```

set p-p2p

Syntax:

```
set p-p2p <port range> <admin p2p>
```

Description:

To set per port admin p2p

Argument:

<port range> syntax: 1,5-7, available from 1 to 24
<admin p2p> : Admin point to point, <auto|true|false>

Possible value:

<port range> syntax: 1,5-7, available from 1 to 24
<admin p2p> : Admin point to point, <auto|true|false>

Example:

```
GEFXL2P-SW24(mstp)# set p-p2p 8-10 auto  
GEFXL2P-SW24(mstp)#
```

set priority

Syntax:

```
set priority <instance-id><Instance Priority>
```

Description:

To set instance priority

Argument:

<instance-id> : 0->CIST; 1-4095->MSTI
<Instance Priority> : must be a multiple of 4096,available from 0 to 61440

Possible value:

<instance-id> : 0->CIST; 1-4095->MSTI

<Instance Priority> : 0 to 61440

Example:

```
GEFXL2P-SW24(mstp)# set priority 0 4096
GEFXL2P-SW24(mstp)# enable
MSTP started
GEFXL2P-SW24(mstp)# show instance 0
mstp status : enabled
force version : 3
instance id: 0
bridge max age : 20
bridge forward delay : 15
bridge max hops : 20
instance priority : 4096
bridge mac : 00:40:c7:5e:00:09
CIST ROOT PRIORITY : 4096
CIST ROOT MAC : 00:40:c7:5e:00:09
CIST EXTERNAL ROOT PATH COST : 0
CIST ROOT PORT ID : 0
CIST REGIONAL ROOT PRIORITY : 4096
CIST REGIONAL ROOT MAC : 00:40:c7:5e:00:09
CIST INTERNAL ROOT PATH COST : 0
CIST CURRENT MAX AGE : 20
CIST CURRENT FORWARD DELAY : 15
TIME SINCE LAST TOPOLOGY CHANGE (SECS) : 2
TOPOLOGY CHANGE COUNT (SECS) : 0
GEFXL2P-SW24(mstp)#
```

set r-role

Syntax:

set r-role <port range> <restricted role>

Description:

To set per port restricted role

Argument:

<port range> syntax: 1,5-7, available from 1 to 24

<restricted role> : 0->>false,1->True

Possible value:

<port range> : 1 to 24

<restricted role> : 0->>false,1->True

Example:

```
GEFXL2P-SW24(mstp)# set r-role 8-12 1
GEFXL2P-SW24(mstp)# set r-role 13-16 0
GEFXL2P-SW24(mstp)# show ports 0
```

Port	Port Status	Role	Path Cost	Pri	Hello	Edge-Port	P2P	Role	Tcn
1	FORWARDING	DSGN	200000	128	2/2		V		
2	DISCARDING	dsb1	2000000	128	2/2	V			
3	DISCARDING	dsb1	2000000	128	2/2	V			
4	DISCARDING	dsb1	2000000	128	2/2	V			

5	FORWARDING	DSGN	200000	128	2/2	V	V	
6	DISCARDING	dsbl	2000000	128	2/2	V		
7	FORWARDING	DSGN	20000	128	2/2	V	V	
8	DISCARDING	dsbl	2000000	128	2/2	V		V
9	DISCARDING	dsbl	2000000	128	2/2	V		V
10	DISCARDING	dsbl	2000000	128	2/2	V		V
11	DISCARDING	dsbl	2000000	128	2/2	V		V
12	DISCARDING	dsbl	2000000	128	2/2	V		V
13	DISCARDING	dsbl	2000000	128	2/2	V		
14	DISCARDING	dsbl	2000000	128	2/2	V		
15	DISCARDING	dsbl	2000000	128	2/2	V		
16	DISCARDING	dsbl	2000000	128	2/2	V		
17	DISCARDING	dsbl	2000000	128	2/2	V		
18	DISCARDING	dsbl	2000000	128	2/2	V		
19	DISCARDING	dsbl	2000000	128	2/2	V		
20	DISCARDING	dsbl	2000000	128	2/2	V		
21	DISCARDING	dsbl	2000000	128	2/2	V		
22	DISCARDING	dsbl	2000000	128	2/2	V		
23	DISCARDING	dsbl	2000000	128	2/2	V		
24	DISCARDING	dsbl	2000000	128	2/2	V		

GEFXL2P-SW24(mstp)#

set r-tcn

Syntax:

set r-tcn <port range> <restricted tcn>

Description:

To set per port restricted tcn

Argument:

<port range> syntax: 1,5-7, available from 1 to 24

<restricted tcn> : 0->>false,1->True

Possible value:

<port range> : 1 to 24

<restricted tcn> : 0->>false,1->True

Example:

```
GEFXL2P-SW24(mstp)# set r-tcn 9-10 1
```

```
GEFXL2P-SW24(mstp)# set r-tcn 14-20 1
```

```
GEFXL2P-SW24(mstp)# show pconf 0
```

Port	Path system	Cost	Priority	Hello Enter in	Edge-Port	P2P	Role	Tcn
2		0	128	2	true	auto	false	false
3		0	128	2	true	auto	false	true
4		0	128	2	true	auto	false	true
5		0	128	2	true	auto	false	false
6		0	128	2	true	auto	false	false
7		0	128	2	true	auto	false	false
8		0	128	2	true	auto	true	false
9		0	128	2	true	auto	true	true

..... (q to quit)

10	0	128	2	true	auto	true	true
11	0	128	2	true	auto	true	false
12	0	128	2	true	auto	true	false
13	0	128	2	true	auto	false	false
14	0	128	2	true	auto	false	true
15	0	128	2	true	auto	false	true
16	0	128	2	true	auto	false	true
17	0	128	2	true	auto	true	true
18	0	128	2	true	auto	true	true
19	0	128	2	true	auto	true	true
20	0	128	2	true	auto	true	true
21	0	128	2	true	auto	true	false
22	0	128	2	true	auto	true	false
23	0	128	2	true	auto	true	false
24	0	128	2	true	auto	true	false

GEFXL2P-SW24(mstp)#

set region-name

Syntax:

set region-name <string>

Description:

To set mstp region name(0~32 bytes)

Argument:

<string> :a null region name

Possible value:

<string> :1-32

Example:

GEFXL2P-SW24(mstp)# set region-name test2

GEFXL2P-SW24(mstp)# show region-info

Name : test2

Revision : 0

Instances : 0

GEFXL2P-SW24(mstp)#

set revision-level

Syntax:

set rev <revision-level>

Description:

To set mstp revision-level(0~65535)

Argument:

<revision-level> :0~65535

Possible value:

<revision-level> :0~65535

Example:

GEFXL2P-SW24(mstp)# set revision-level 30000

GEFXL2P-SW24(mstp)# show region-info

Name : test2
Revision : 30000
Instances : 0
GEFXL2P-SW24(mstp)#

set version

Syntax:

set version <stp|rstp|mstp>

Description:

To set force-version

Argument:

<revision-level> :0~65535

Possible value:

<revision-level> :0~65535

Example:

GEFXL2P-SW24 (mstp)# set version mstp

show instance

Syntax:

show instance <instance-id>

Description:

To show instance status

Argument:

<instance-id> :0->CIST;1-4095->MSTI

Possible value:

<instance-id> :0->CIST;1-4095->MSTI

Example:

```
GEFXL2P-SW24(mstp)# show instance 0
mstp status : enabled
force version : 2
instance id: 0
bridge max age : 20
bridge forward delay : 15
bridge max hops : 20
instance priority : 4096
bridge mac : 00:40:c7:5e:00:09
CIST ROOT PRIORITY : 4096
CIST ROOT MAC : 00:40:c7:5e:00:09
CIST EXTERNAL ROOT PATH COST : 0
CIST ROOT PORT ID : 0
CIST REGIONAL ROOT PRIORITY : 4096
CIST REGIONAL ROOT MAC : 00:40:c7:5e:00:09
CIST INTERNAL ROOT PATH COST : 0
CIST CURRENT MAX AGE : 20
CIST CURRENT FORWARD DELAY : 15
TIME SINCE LAST TOPOLOGY CHANGE(SECs) : 2569
TOPOLOGY CHANGE COUNT(SECs) : 0
```

GEFXL2P-SW24(mstp)#

show pconf

Syntax:

show pconf <instance-id>

Description:

To show port configuration

Argument:

instance-id:0->CIST;1-4095->MSTI

Possible value:

<instance-id> :0->CIST;1-4095->MSTI

Example:

GEFXL2P-SW24(mstp)# show pconf 0

set	r-role		Se					
2	0	128	2	true	auto	false	false	
3	0	128	2	true	auto	false	true	
4	0	128	2	true	auto	false	true	
5	0	128	2	true	auto	false	false	
6	0	128	2	true	auto	false	false	
7	0	128	2	true	auto	false	false	
8	0	128	2	true	auto	true	false	
9	0	128	2	true	auto	true	true	
10	0	128	2	true	auto	true	true	
11	0	128	2	true	auto	true	false	
12	0	128	2	true	auto	true	false	
13	0	128	2	true	auto	false	false	
14	0	128	2	true	auto	false	true	
15	0	128	2	true	auto	false	true	
16	0	128	2	true	auto	false	true	
17	0	128	2	true	auto	true	true	
18	0	128	2	true	auto	true	true	
19	0	128	2	true	auto	true	true	
20	0	128	2	true	auto	true	true	
21	0	128	2	true	auto	true	false	
22	0	128	2	true	auto	true	false	
23	0	128	2	true	auto	true	false	
24	0	128	2	true	auto	true	false	

GEFXL2P-SW24(mstp)#

show ports

Syntax:

show ports <instance-id>

Description:

To show port status

Argument:

instance-id:0->CIST;1-4095->MSTI

Possible value:

<instance-id> :0->CIST;1-4095->MSTI

Example:

```
GEFXL2P-SW24(mstp)# show ports 0
```

show region-info**Syntax:**

```
show region-info
```

Description:

To show region config

Argument:

none

Possible value:

none

Example:

```
GEFXL2P-SW24(mstp)# show region-info
```

```
Name : test2
```

```
Revision : 30000
```

```
Instances : 0
```

```
GEFXL2P-SW24(mstp)#
```

show vlan-map**Syntax:**

```
show vlan-map <instance-id>
```

Description:

To show vlan mapping of an instance

Argument:

```
<instance-id> :0->CIST;1-4095->MSTI
```

Possible value:

```
<instance-id> :0->CIST;1-4095->MSTI
```

Example:

```
GEFXL2P-SW24(mstp)# show vlan-map 0
```

```
instance 0 has those vlans :
```

```
0-4095
```

```
GEFXL2P-SW24(mstp)#
```

■ policy***add*****Syntax:**

```
add [name <value>] [ip <value>] [port <value>] [type <value>] action <value>
```

Description:

To add a new management policy entry.

Argument:

```
Synopsis: add name George ip 192.168.1.1-192.168.1.90 port 2-5,8  
type h,s action a
```

```
Synopsis: add name Mary ip 192.168.2.1-192.168.2.90 action deny
```

Possible value:

None

Example:

```
GEFXL2P-SW24(policy)# add name Mary ip 192.168.3.1-192.168.3.4 action deny
GEFXL2P-SW24(policy)# show
```

- 1) Name : george IP Range : 192.168.1.1-192.168.1.90
Action : Accept Access Type : HTTP SNMP
Port : 2 3 4 5 8

- 2) Name : rule1 IP Range : 192.168.2.1-192.168.2.30
Action : Deny Access Type : HTTP TELENT SNMP
Port : 11 12 13 14 15

- 3) Name : Mary IP Range : 192.168.3.1-192.168.3.4
Action : Deny Access Type : Any
Port : Any

```
GEFXL2P-SW24(policy)#
```

delete

Syntax:

```
delete <index>
```

Description:

To add a new management policy entry.

Argument:

<index> : a specific or range management policy entry(s)

e.g. delete 2,3,8-12

Possible value:

<index> : a specific or range management policy entry(s)

Example:

```
GEFXL2P-SW24(policy)# add name rule2 ip 192.168.4.23-192.168.4.33 port 6-8
type s,t
action d
```

```
GEFXL2P-SW24(policy)# show
```

- 1) Name : rule1 IP Range : 192.168.4.5-192.168.4.22
Action : Deny Access Type : HTTP TELENT SNMP
Port : 2 3 4 5

- 2) Name : rule2 IP Range : 192.168.4.23-192.168.4.33
Action : Deny Access Type : TELENT SNMP
Port : 6 7 8

```
GEFXL2P-SW24(policy)# delete 2
```

```
GEFXL2P-SW24(policy)# show
```

- 1) Name : rule1 IP Range : 192.168.4.5-192.168.4.22
Action : Deny Access Type : HTTP TELENT SNMP
Port : 2 3 4 5

```
GEFXL2P-SW24(policy)#
```

show

Syntax:

show

Description:

To show management policy list.

Argument:

none

Possible value:

none

Example:

GEFXL2P-SW24(policy)# show

```
1) Name      : rule1          IP Range    : 192.168.4.5-192.168.4.22
   Action    : Deny          Access Type : HTTP TELENT SNMP
   Port      : 2 3 4 5

2) Name      : rule2          IP Range    : 192.168.4.23-192.168.4.33
   Action    : Deny          Access Type : TELENT SNMP
   Port      : 6 7 8
```

■ **port**

clear counter

Syntax:

clear counter

Description:

To clear all ports' counter (include simple and detail port counter) information.

Argument:

None

Possible value:

None

Example:

GEFXL2P-SW24 (port)# clear counter

set description

Syntax:

set description <port-range> <description>

Description:

To set port description

Argument:

<port range> syntax : 1,5-7, available from 1 to 24

<description> : set port description, max 47 characters

Possible value:

<port range> : 1 to 24

<description> : max 47 characters

Example:

```
GEFXL2P-SW24(port)# set description 3-8 salesdepartment
GEFXL2P-SW24(port)# show config
      Speed/   Flow   Maximum ExcessiveSynopsis: add name George ip
192.168.1.1-
Port Duplex   Control   Frame   Collision   Description
type
  2 Auto      Disabled  9600    Discard
  3 Auto      Disabled  9600    Discard  salesdepartment
  4 Auto      Disabled  9600    Discard  salesdepartment
  5 Auto      Disabled  9600    Discard  salesdepartment
  6 Auto      Disabled  9600    Discard  salesdepartment
  7 Auto      Disabled  9600    Discard  salesdepartment
  8 Auto      Disabled  9600    Discard  salesdepartment
  9 Auto      Disabled  9600    Discard
```

set excessive-collision**Syntax:**

```
set excessive-collision <port-range> <discard|restart>
```

Description:

To set port description

Argument:

<port range> syntax : 1,5-7, available from 1 to 24

Possible value:

<port range> : 1 to 24

Example:

```
GEFXL2P-SW24(port)# set excessive-collision 6-10 restart
GEFXL2P-SW24(port)# show config
      Speed/   Flow   Maximum Excessive
Port Duplex   Control   Frame   Collision   Description a list of
previously run command set priority
```

DISCAR

```
  2 Auto      Disabled  9600    Discard
  3 Auto      Disabled  9600    Discard  salesdepartment
  4 Auto      Disabled  9600    Discard  salesdepartment
  5 Auto      Disabled  9600    Discard  salesdepartment
  6 Auto      Disabled  9600    Restart  salesdepartment
  7 Auto      Disabled  9600    Restart  salesdepartment
  8 Auto      Disabled  9600    Restart  salesdepartment
  9 Auto      Disabled  9600    Restart
 10 Auto      Disabled  9600    Restart
 11 Auto      Disabled  9600    Discard
```

set flow-control**Syntax:**

set flow-control <port-range> <enable|disable>

Description:

To set per-port flow control

Argument:

<port-range>: syntax 1,5-7, available from 1 to 24

Possible value:

<port-range>: 1 ~ 24

Example:

```
GEFXL2P-SW24(port)# set flow-control 3-10
```

```
GEFXL2P-SW24(port)# show config
```

```
1 Auto      Disabled  9600    Discard
2 Auto      Disabled  9600    Discard
3 Auto      Enabled   9600    Discard  salesdepartment
4 Auto      Enabled   9600    Discard  salesdepartment
5 Auto      Enabled   9600    Discard  salesdepartment
6 Auto      Enabled   9600    Restart  salesdepartment
7 Auto      Enabled   9600    Restart  salesdepartment
8 Auto      Enabled   9600    Restart  salesdepartment
9 Auto      Enabled   9600    Restart
10 Auto     Enabled   9600    Restart
11 Auto     Disabled  9600    Discard
12 Auto     Disabled  9600    Discard
```

set max-frame

Syntax:

set max-frame <port-range> <value>

Description:

To set per-port maximum frame size

Argument:

<port range> syntax : 1,5-7, available from 1 to 24

<value> : Allowed value are 1518-9600 bytes.

Possible value:

<port range> syntax : 1 to 24

<value> : 1518-9600 bytes.

Example:

```
GEFXL2P-SW24(port)# set max-frame 3-6 1518
```

```
GEFXL2P-SW24(port)# show config
```

```
      Speed/   Flow   Maximum Excessiveommands
2 Auto      Disabled  9600    Discard
3 Auto      Enabled   1518    Discard  salesdepartment
4 Auto      Enabled   1518    Discard  salesdepartment
5 Auto      Enabled   1518    Discard  salesdepartment
6 Auto      Enabled   1518    Restart  salesdepartment
7 Auto      Enabled   9600    Restart  salesdepartment
8 Auto      Enabled   9600    Restart  salesdepartment
9 Auto      Enabled   9600    Restart
10 Auto     Enabled   9600    Restart
```

set speed

Syntax:

set speed <port-range> <disable|auto|1Gfull|100full|100half|10full|10half>

Description:

To set port capability.

Argument:

<port-range>:syntax 1,5-7, available from 1 to 24

<port-speed>:

auto: set auto-negotiation mode

10half: set speed/duplex 10M Half

10full: set speed/duplex 10M Full

100half: set speed/duplex 100M Half

100full: set speed/duplex 100M Full

1Gfull: set speed/duplex 1G Full

Possible value:

<port-range>: 1 to 24

<port-speed>: auto, 10half, 10full, 100half, 100full, 1Gfull

Example:

```
GEFXL2P-SW24(port)# set speed 3 auto
```

```
GEFXL2P-SW24(port)# show status
```

Port	Link	Duplex	Rx Pause	Tx Pause	Description
1	Up	100M/Full	Disabled	Disabled	
2	Down	Down	Disabled	Disabled	
3	Up	100M/Full	Disabled	Disabled	
4	Down	Down	Disabled	Disabled	
5	Down	Down	Disabled	Disabled	
6	Down	Down	Disabled	Disabled	
7	Up	1G/Full	Disabled	Disabled	
8	Down	Down	Disabled	Disabled	
9	Down	Down	Disabled	Disabled	

set powersaving

Syntax:

set set powersaving <port> <0|1>

Description:

To set power saving.

Argument:

port: 1,5-7, available from 1 to 8

0: Disable, 1: Enable

Possible value:

<port-index>: 1 to 16

<power saving>:0: Disable, 1: Enable

Example:

```
GEFXL2P-SW24 (port)# set powersaving 2 1
GEFXL2P-SW24 (port)#
```

show config**Syntax:**

```
show config
```

Description:

To display the each port's configuration information.

Argument:

None.

Possible value:

None.

Example:

```
GEFXL2P-SW24(port)# show config
```

Port	Speed/ Duplex	Flow Control	Maximum Frame	Excessive Collision	Description
1	Auto	Disabled	9600	Discard	
2	1G/Full	Disabled	9600	Discard	
3	Auto	Disabled	9600	Discard	
4	1G/Full	Disabled	9600	Discard	
5	1G/Full	Disabled	9600	Discard	
6	Auto	Disabled	9600	Discard	
7	Auto	Disabled	9600	Discard	
8	Auto	Disabled	9600	Discard	
9	Auto	Disabled	9600	Discard	
10	Auto	Disabled	9600	Discard	
11	Auto	Disabled	9600	Discard	
12	Auto	Disabled	9600	Discard	

show detail-counter**Syntax:**

```
show detail-counter <port>
```

Description:

To display the display detail port counter.

Argument:

<port>: port, available from 1 to 24

Possible value:

<port>:1 ~ 24

Example:

```
GEFXL2P-SW24 (port)# show detail-counter 3
```

Rx Multicast	6	Tx Multicast	641
Rx Broadcast	94	Tx Broadcast	5251
Rx Pause	0	Tx Pause	0

Receive Size Counters		Transmit Size Counters	
Rx 64 Bytes	7381	Tx 64 Bytes	4351
Rx 65-127 Bytes	291	Tx 65-127 Bytes	2342
Rx 128-255 Bytes	118	Tx 128-255 Bytes	605
Rx 256-511 Bytes	53	Tx 256-511 Bytes	1081
Rx 512-1023 Bytes	33	Tx 512-1023 Bytes	144
Rx 1024-1526 Bytes	28	Tx 1024-1526 Bytes	11453
Rx 1527- Bytes	0	Tx 1527- Bytes	0

Receive Error Counters		Transmit Error Counters	
Rx Drops	0	Tx Drops	0
Rx CRC/Alignment	0	Tx Late/Exc. Coll.	0
Rx Undersize	0		
Rx Oversize	0		
Rx Fragments	0		
Rx Jabber	0		

show sfp

Syntax:

show sfp <port>

Description:

To display the SFP module information.

Argument:

<port>: SFP port of the switch, available from 1 to 24

Possible value:

<port>: 1- 24,

Example:

```
GEFXL2P-SW24(port)# show sfp 11
```

Port 11 SFP information

```
-----
Connector Type      : SFP - Unknown or unspecified
Fiber Type          : Reserved
Tx Central Wavelength : 0
Baud Rate           : 1G
Vendor OUI          : 00:00:00
Vendor Name         : FIBERXON INC.
Vendor PN           : FTM-C012R-LC
Vendor Rev          : 10
Vendor SN           : PP220052901281
Date Code           : 051012
Temperature         : none
Vcc                 : none
Mon1 (Bias) mA     : none
Mon2 (TX PWR)      : none
```

Mon3 (RX PWR) : none
GEFXL2P-SW24(port)#
Port 23 SFP information

Connector Type : SFP - LC
Fiber Type : Multi-mode (MM)
Tx Central Wavelength : 850
Baud Rate : 1G
Vendor OUI : 00:40:c7
Vendor Name : APAC Opto
Vendor PN : KM28-C3S-TC-N
Vendor Rev : 0000
Vendor SN : 5425010708
Date Code : 050530
Temperature : none
Vcc : none
Mon1 (Bias) mA : none
Mon2 (TX PWR) : none
Mon3 (RX PWR) : none

show simple-counter

Syntax:

show simple-counter

Description:

To display the summary counting of each port's traffic.

Argument:

None.

Possible value:

None.

Example:

```
GEFXL2P-SW24 (port)# show simple-counter  
set max-frame          Set per-port maximum frame size
```

13	0	0	0	0	0	0	0	0
14	0	0	0	0	0	0	0	0
15	0	0	0	0	0	0	0	0
16	0	0	0	0	0	0	0	0
17	0	0	0	0	0	0	0	0
18	0	0	0	0	0	0	0	0
19	0	0	0	0	0	0	0	0
20	0	0	0	0	0	0	0	0
21	0	0	0	0	0	0	0	0
22	0	0	0	0	0	0	0	0
23	0	0	0	0	0	0	0	0
24	0	0	0	0	0	0	0	0

GEFXL2P-SW24(port)#

show status

Syntax:

show status

Description:

To display the port's current status.

Argument:

None.

Possible value:

None.

Example:

```
GEFXL2P-SW24(port)# show status
                Speed/1G/Full  Disable
Port Link Duplex  Rx Pause Tx Pause  Description
  3 Auto      Disabled 9600   Discard
  2 Down Down      Disabled Disabled
  3 Up   100M/Full Disabled Disabled
  4 Down Down      Disabled Disabled
  5 Down Down      Disabled Disabled
  6 Down Down      Disabled Disabled
  7 Up   1G/Full  Disabled Disabled
  ...
```

GEFXL2P-SW24(port)#

show Powersaving

Syntax:

show powersaving

Description:

To display the port's powersaving status.

Argument:

None.

Possible value:

None.

Example:

```
GEFXL2P-SW24 (port)# show powersaving
Port Power Saving
-----
 1 Disabled
 2 Disabled
 3 Disabled
 4 Disabled
 5 Disabled
 6 Disabled
 7 Disabled
 8 Disabled
GEFXL2P-SW24 (port)#
```

■ qos

<<ports>>

set class

Syntax:

set class <#>

Description:

To set number of classes.

Argument:

#: Number of classes, available 1, 2, 4

Possible value:

<#>: 1,2,4

Example:

```
GEFXL2P-SW24(qos-ports)# set class 2
```

```
GEFXL2P-SW24(qos-ports)#
```

set port

Syntax:

set port <range> <default class> <qcl> <user priority> <queuing mode> <low queue weighted> <normal queue weighted> <medium queue weighted> <high queue weighted>

Description:

To set port information.

Argument:

<range syntax>: 1,5-7, available from 1 to 24

<default class option>: low | normal | medium | high

<qcl> : available from 1 to 24

<user priority>: available from 0 to 7

<queuing mode>: strict | weighted

<low queue weighted>: 1 / 2 / 4 / 8

<normal queue weighted>: 1 / 2 / 4 / 8

<medium queue weighted> : 1 / 2 / 4 / 8

<high queue weighted>: 1 / 2 / 4 / 8

Possible value:

<range syntax>: 1 to 24

<default class option>: low | normal | medium | high

<qcl> : 1 to 24

<user priority>: 0 to 7

<queuing mode>: strict | weighted

<low queue weighted>: 1 / 2 / 4 / 8

<normal queue weighted>: 1 / 2 / 4 / 8

<medium queue weighted> : 1 / 2 / 4 / 8

<high queue weighted>: 1 / 2 / 4 / 8

Example:

```
GEFXL2P-SW24(qos-ports)# set port 2 medium 1 3 weithted 2 2 2 2
```



```
GEFXL2P-SW24(qos-ports)# show
 2 Medium      1      3      Weighted Fair    2 /  2 /  2 /  2
 3 Low         1      0      Strict Priority  1 /  2 /  4 /  8
 4 Low         1      0      Strict Priority  1 /  2 /  4 /  8
 5 Low         1      0      Strict Priority  1 /  2 /  4 /  8
 6 Low         1      0      Strict Priority  1 /  2 /  4 /  8
 7 Low         1      0      Strict Priority  1 /  2 /  4 /  8
 8 Low         1      0      Strict Priority  1 /  2 /  4 /  8
 9 Low         1      0      Strict Priority  1 /  2 /  4 /  8
10 Low         1      0      Strict Priority  1 /  2 /  4 /  8
11 Low         1      0      Strict Priority  1 /  2 /  4 /  8
12 Low         1      0      Strict Priority  1 /  2 /  4 /  8
13 Low         1      0      Strict Priority  1 /  2 /  4 /  8
14 Low         1      0      Strict Priority  1 /  2 /  4 /  8
.....
```

```
GEFXL2P-SW24(qos-ports)#
```

show

Syntax:

```
show
```

Description:

To show port information.

Argument:

none

Possible value:

none

Example:

```
GEFXL2P-SW24(qos-ports)# show
Number of Classes:2
 2 Medium      1      3      Weighted Fair    2 /  2 /  2 /  2
 3 Low         1      0      Strict Priority  1 /  2 /  4 /  8
 4 Low         1      0      Strict Priority  1 /  2 /  4 /  8
 5 Low         1      0      Strict Priority  1 /  2 /  4 /  8
 6 Low         1      0      Strict Priority  1 /  2 /  4 /  8
 7 Low         1      0      Strict Priority  1 /  2 /  4 /  8
 8 Low         1      0      Strict Priority  1 /  2 /  4 /  8
 9 Low         1      0      Strict Priority  1 /  2 /  4 /  8
10 Low         1      0      Strict Priority  1 /  2 /  4 /  8
```

```
<<qcl>>
```

set

Syntax:

```
set <dscp> <tos> <tagpriority> <qce type> <value> <class>
```

Description:

To add the QCE entry in the specific QCL

Argument:

<dscp>: dscp field, syntax 1,5-7, available from 0 to 63

< tos> : tos priority , available from 1 to 8
< tagpriority> : tag priority, available from 1 to 8
<qce type> : ethernet
<value> : 0xffff0
<class> : high

Possible value:

<dscp>: dscp field, syntax 1,5-7, available from 0 to 63
< tos> : tos priority , available from 1 to 8
< tagpriority> : tag priority, available from 1 to 8
<qce type> : ethernet
<value> : 0xffff0
<class> : high

Example:

```
GEFXL2P-SW24(qos-qcl)# set 2 0 3 ethernet 0xffff0 high  
GEFXL2P-SW24(qos-qcl)# show 2 1
```

```
QCE Type:           Ethernet Type  
Ethernet Type Value:0xffff0  
Traffic Class:      High
```

```
GEFXL2P-SW24(qos-qcl)#
```

move

Syntax:

```
move <qcl> <qce> <new qce>
```

Description:

To move up the specific QCE entry in the specific QCL

Argument:

<qcl> : the qcl number, available from 1 to 24.
<qce> : the original qce number, available from 1 to 12.
<new qce> : the new qce number, available from 1 to 12.

Possible value:

<qcl> : available from 1 to 24.
<qce> : available from 1 to 12.
<new qce> : available from 1 to 12.

Example:

```
GEFXL2P-SW24(qos-qcl)# move 2 1 1
```

delete

Syntax:

```
delete <qcl> <qce range>
```

Description:

To delete the specific QCE entry in the specific QCL.

Argument:

<qcl> : the qcl number, available from 1 to 24.
<qce range> : 1,5-7, available from 1 to 12

Possible value:

<qcl> : available from 1 to 24.
<qce range> : available from 1 to 12

Example:

```
GEFXL2P-SW24(qos-qcl)# delete 2 1
```

<<*rate*>>

set**Syntax:**

```
set <range> <policer enabled> <rate> <unit> <shaper enabled> <rate> <unit>
```

Description:

To set rate limit configuration

Argument:

<range syntax> : 1,5-7, available from 1 to 24

<policer enabled> : 1 means enable and 0 means disable

<rate>: allowed values are 500kbps-1Gkps

<unit>: 'k' means kbps and 'm' means mbps

<shaper enabled>: 1 means enable and 0 means disable

<rate>: allowed values are 500kbps-1Gkps

<unit>: 'k' means kbps and 'm' means mbps

Possible value:

range syntax: 1,5-7, available from 1 to 24

policer enabled: 1 means enable and 0 means disable

rate: allowed values are 500kbps-1Gkps

unit: 'k' means kbps and 'm' means mbps

shaper enabled: 1 means enable and 0 means disable

rate: allowed values are 500kbps-1Gkps

unit: 'k' means kbps and 'm' means mbps

Example:

```
GEFXL2P-SW24(qos-rate)# set 2 1 1000 m 1 1000 m
```

```
GEFXL2P-SW24(qos-rate)# show
```

2	V	1000	Mbps	V	1000	Mbps
3		500	kbps		500	kbps
4		500	kbps		500	kbps
5		500	kbps		500	kbps
6		500	kbps		500	kbps
7		500	kbps		500	kbps
8		500	kbps		500	kbps
9		500	kbps		500	kbps
10		500	kbps		500	kbps

<< *storm* >>

set broadcast**Syntax:**

```
set broadcast <status> <rate>
```

Description:

To set broadcast storm control configuration

Argument:

<status> : 1 means enable and 0 means disable
<rate> : 1, 2, 4, 8, 16, 32, 64, 128, 256, 512, 1k, 2k, 4k, 8k, 16k, 32k, 64k, 128k, 256k, 512k

Possible value:

<status> : 1 means enable and 0 means disable
<rate> : 1, 2, 4, 8, 16, 32, 64, 128, 256, 512, 1k, 2k, 4k, 8k, 16k, 32k, 64k, 128k, 256k, 512k

Example:

```
GEFXL2P-SW24(qos-storm)# set broadcast 1 512  
GEFXL2P-SW24(qos-storm)# show
```

Frame Type	Status	Rate(Packet Per Second)
Flooded unicast		1
Multicast		1
Broadcast	V	512

set multicast

Syntax:

```
set multicast <status> <rate>
```

Description:

To set multicast storm control configuration

Argument:

<status> : 1 means enable and 0 means disable
<rate> : 1, 2, 4, 8, 16, 32, 64, 128, 256, 512, 1k, 2k, 4k, 8k, 16k, 32k, 64k, 128k, 256k, 512k

Possible value:

<status> : 1 means enable and 0 means disable
<rate> : 1, 2, 4, 8, 16, 32, 64, 128, 256, 512, 1k, 2k, 4k, 8k, 16k, 32k, 64k, 128k, 256k, 512k

Example:

```
GEFXL2P-SW24(qos-storm)# set multicast 1 64  
GEFXL2P-SW24(qos-storm)# show
```

Frame Type	Status	Rate(Packet Per Second)
Flooded unicast		1
Multicast	V	64
Broadcast	V	512

set unicast

Syntax:

```
set unicast <status> <rate>
```

Description:

To set flooded unicast storm control configuration

Argument:

<status> : 1 means enable and 0 means disable

<rate> : 1, 2, 4, 8, 16, 32, 64, 128, 256, 512, 1k, 2k, 4k, 8k, 16k, 32k, 64k, 128k, 256k, 512k

Possible value:

<status> : 1 means enable and 0 means disable

<rate> : 1, 2, 4, 8, 16, 32, 64, 128, 256, 512, 1k, 2k, 4k, 8k, 16k, 32k, 64k, 128k, 256k, 512k

Example:

```
GEFXL2P-SW24(qos-storm)# set unicast 1 128
```

```
GEFXL2P-SW24(qos-storm)# show
```

Frame Type	Status	Rate(Packet Per Second)
Flooded unicast	V	128
Multicast	V	64
Broadcast	V	512

show

Syntax:

```
show
```

Description:

To show storm control configuration

Argument:

none

Possible value:

none

Example:

```
GEFXL2P-SW24(qos-storm)# show
```

Frame Type	Status	Rate(Packet Per Second)
Flooded unicast	V	128
Multicast	V	64
Broadcast	V	512

■ **reboot**

reboot

Syntax:

```
reboot
```

Description:

To reboot the system.

Argument:

None.

Possible value:

None.

Example:

```
GEFXL2P-SW24# reboot
```

■ snmp

<<disable>>

Syntax:

disable set-ability
disable snmp

Description:

The Disable here is used for the de-activation of snmp or set-community.

Argument:

None.

Possible value:

None.

Example:

```
GEFXL2P-SW24(snmp)# disable snmp  
GEFXL2P-SW24(snmp)# disable set-ability
```

<<enable>>

Syntax:

enable set-ability
enable snmp

Description:

The Enable here is used for the activation snmp or set-community.

Argument:

None.

Possible value:

None.

Example:

```
GEFXL2P-SW24(snmp)# enable snmp  
GEFXL2P-SW24(snmp)# enable set-ability
```

<<set>>

Syntax:

```
set get-community <community>  
set set-community <community>  
set trap <#> <ip> [port] [community]
```

Description:

The Set here is used for the setup of get-community, set-community, trap host ip, host port and trap-community.

Argument:

<#>: trap number
<ip>: ip address or domain name
<port>: trap port
<community>:trap community name

Possible value:

<#>: 1 to 6
<port>:1~65535

Example:

```
GEFXL2P-SW24(snmp)# set get-community public
GEFXL2P-SW24(snmp)# set set-community private
GEFXL2P-SW24(snmp)# set trap 1 192.168.1.1 162 public
```

show**Syntax:**

show

Description:

The Show here is to display the configuration of SNMP.

Argument:

None.

Possible value:

None.

Example:

```
GEFXL2P-SW24(snmp)# show
SNMP          : Enable
Get Community: public
Set Community: private [Enable]
Trap Host 1 IP Address: 192.168.1.1 Port: 162 Community: public
Trap Host 2 IP Address: 0.0.0.0 Port: 162 Community: public
Trap Host 3 IP Address: 0.0.0.0 Port: 162 Community: public
Trap Host 4 IP Address: 0.0.0.0 Port: 162 Community: public
Trap Host 5 IP Address: 0.0.0.0 Port: 162 Community: public
Trap Host 6 IP Address: 0.0.0.0 Port: 162 Community: public
```

■ stp

MCheck

Syntax:

MCheck <range>

Description:

To force the port to transmit RST BPDUs.

Argument:

<range>: syntax 1,5-7, available from 1 to 24

Possible value:

<range>: 1 to 24

Example:

GEFXL2P-SW24(stp)# Mcheck 1-8

disable

Syntax:

disable

Description:

To disable the STP function.

Argument:

None.

Possible value:

None.

Example:

GEFXL2P-SW24(stp)# disable

enable

Syntax:

enable

Description:

To enable the STP function.

Argument:

None.

Possible value:

None.

Example:

GEFXL2P-SW24(stp)# enable

set config

Syntax:

set config <Bridge Priority> <Hello Time> <Max. Age> <Forward Delay>

Description:

To set up the parameters of STP.

Argument:

<Bridge Priority>: priority must be a multiple of 4096, available from 0 to 61440.

<Hello Time>: available from 1 to 10.

<Max. Age>: available from 6 to 40.

<Forward Delay>: available from 4 to 30.

Note: $2 * (\text{Forward Delay} - 1) \geq \text{Max Age}$

$\text{Max Age} \geq 2 * (\text{Hello Time} + 1)$

Possible value:

<Bridge Priority>: 0 to 61440

<Hello Time>: 1 to 10

<Max. Age>: 6 to 40

<Forward Delay>: 4 to 30

Example:

```
GEFXL2P-SW24(stp)# set config 61440 2 20 15
```

set port

Syntax:

set port <range> <path cost> <priority> <edge_port> <admin p2p>

Description:

To set up the port information of STP.

Argument:

<range>: syntax 1,5-7, available from 1 to 24

<path cost>: 0, 1-200000000. The value zero means auto status

<priority>: priority must be a multiple of 16, available from 0 to 240

<edge_port> : Admin Edge Port, <yes|no>

<admin p2p>: Admin point to point, <auto|true|false>

Possible value:

<range>: 1 to 24

<path cost>: 0, 1-200000000

<priority>: 0 to 240

<edge_port>: yes / no

<admin p2p>: auto / true / false

Example:

```
GEFXL2P-SW24(stp)# set port 1-16 0 128 yes auto
```

set version

Syntax:

set version <stp|rstp>

Description:

To set up the version of STP.

Argument:

<stp|rstp>:stp / rstp

Possible value:

<stp|rstp>:stp / rstp

Example:

```
GEFXL2P-SW24(stp)# set version rstp
```

show config

Syntax:

show config

Description:

To display the configuration of STP.

Argument:

None.

Possible value:

None.

Example:

```
GEFXL2P-SW24(stp)# show config
STP State Configuration      :
Spanning Tree Protocol      : Enabled
Bridge Priority (0-61440)    : 61440
Hello Time (1-10 sec)       : 2
Max. Age (6-40 sec)         : 20
Forward Delay (4-30 sec)    : 15
Force Version                : RSTP
```

show port

Syntax:

show port

Description:

To display the port information of STP.

Argument:

None.

Possible value:

None.

Example:

```
GEFXL2P-SW24# stp
```

```
GEFXL2P-SW24(stp)# show port
```

```
Port Port Status Path Cost Priority Admin Edge Port Admin Point To Point
```

```
=====
```

1	DISCARDING	2000000	128	No	Auto
2	DISCARDING	2000000	128	No	Auto
3	DISCARDING	2000000	128	No	Auto
4	DISCARDING	2000000	128	No	Auto
5	DISCARDING	2000000	128	No	Auto
6	DISCARDING	2000000	128	No	Auto
7	DISCARDING	2000000	128	No	Auto
8	DISCARDING	2000000	128	No	Auto
9	DISCARDING	2000000	128	No	Auto
10	DISCARDING	2000000	128	No	Auto
11	DISCARDING	2000000	128	No	Auto
12	DISCARDING	2000000	128	No	Auto
13	DISCARDING	2000000	128	No	Auto
14	DISCARDING	2000000	128	No	Auto
15	DISCARDING	2000000	128	No	Auto
16	DISCARDING	2000000	128	No	Auto
17	DISCARDING	2000000	128	No	Auto
18	DISCARDING	2000000	128	No	Auto
19	DISCARDING	2000000	128	No	Auto
20	DISCARDING	2000000	128	No	Auto
21	DISCARDING	2000000	128	No	Auto
22	DISCARDING	2000000	128	No	Auto
... (q to quit)					
23	DISCARDING	2000000	128	No	Auto
24	DISCARDING	2000000	128	No	Auto

show status

Syntax:

show status

Description:

To display the status of STP.

Argument:

None.

Possible value:

None.

Example:

GEFXL2P-SW24(stp)# show status

STP Status :

STP State	: Enabled
Bridge ID	: 00:40:C7:D8:09:1D
Bridge Priority	: 61440
Designated Root	: 00:40:C7:D8:09:1D
Designated Priority	: 61440
Root Port	: 0
Root Path Cost	: 0
Current Max. Age(sec)	: 20
Current Forward Delay(sec)	: 15
Hello Time(sec)	: 2
STP Topology Change Count	: 0
Time Since Last Topology Change(sec)	: 848

■ system

set contact

Syntax:

set contact <contact string>

Description:

To set the contact description of the switch.

Argument:

<contact>: string length up to 40 characters.

Possible value:

<contact>: A, b, c, d, ... ,z and 1, 2, 3, etc.

Example:

GEFXL2P-SW24(system)# set contact Taipei

set device-name

Syntax:

set device-name <device-name string>

Description:

To set the device name description of the switch.

Argument:

<device-name>: string length up to 40 characters.

Possible value:

<device-name>: A, b, c, d, ... ,z and 1, 2, 3, etc.

Example:

GEFXL2P-SW24(system)# set device-name CR-2600

set location

Syntax:

set location <location string>

Description:

To set the location description of the switch.

Argument:

<location>: string length up to 40 characters.

Possible value:

<location>: A, b, c, d, ... ,z and 1, 2, 3, etc.

Example:

GEFXL2P-SW24(system)# set location Taipei

show

Syntax:

show

Description:

To display the basic information of the switch.

Argument:

None.

Possible value:

None.

Example:

```
GEFXL2P-SW24(system)# show
Model Name                : GEFXL2P-SW24
System Description        : L2 Managed Switch
Location                  :
Contact                   :
Device Name               : GEFXL2P-SW24
System Up Time            : 0 Days 0 Hours 4 Mins 14 Secs
Current Time              : Tue Jan 17 16:28:46 2006
BIOS Version              : v1.05
Firmware Version         : v2.08
Hardware-Mechanical Version : v1.01-v1.01
Serial Number             : 030C02000003
Host IP Address           : 192.168.1.1
Host MAC Address          : 00-40-c7-e7-00-10
Device Port               : UART * 1, TP * 22, Dual-Media Port (RJ45/SFP)
* 2
RAM Size                  : 16 M
Flash Size                : 2 M
```

■ **traplog**

clear

Syntax:

clear

Description:

To clear trap log.

Argument:

none

Possible value:

none

Example:

```
GEFXL2P-SW24(traplog)# clear
GEFXL2P-SW24(traplog)# show
```

```
No                time                desc
```

show

Syntax:

show

Description:

To display the trap log.

Argument:

None.

Possible value:

None.

Example:

```
GEFXL2P-SW24(tftp)# show
2 Mon Mar 17 15:18:38 2008gvrp mode> <qce type> .
    Dual Media Swapped [Port:1][SwapTo:TP]ge hostnamexit / 4 / 8
3 Mon Mar 17 15:18:38 2008nto igmp mode, available from
    Link Up [Port:1]Enter into ip mode
6 Mon Mar 17 15:18:38 2008
    Dual Media Swapped [Port:5][SwapTo:TP]
7 Mon Mar 17 15:18:38 2008
    Link Up [Port:5]
8 Mon Mar 17 15:18:48 2008
    Login [admin]
```

■ **time**

set daylightsaving

Syntax:

```
set daylightsaving <hr> <MM/DD/HH> <mm/dd/hh>
```

Description:

To set up the daylight saving.

Argument:

```
hr   : daylight saving hour, range: -5 to +5
MM   : daylight saving start Month (01-12)
DD   : daylight saving start Day (01-31)
HH   : daylight saving start Hour (00-23)
mm   : daylight saving end Month (01-12)
dd   : daylight saving end Day (01-31)
hh   : daylight saving end Hour (00-23)
```

Possible value:

```
hr   : -5 to +5
MM   : (01-12)
DD   : (01-31)
HH   : (00-23)
mm   : (01-12)
dd   : (01-31)
hh   : (00-23)
```

Example:

```
GEFXL2P-SW24(time)# set daylightsaving 3 10/12/01 11/12/01
Save Successfully
```

set manual**Syntax:**

```
set manual <YYYY/MM/DD> <hh:mm:ss>
```

Description:

To set up the current time manually.

Argument:

YYYY	: Year	(2000-2036)	MM	: Month	(01-12)
DD	: Day	(01-31)	hh	: Hour	(00-23)
mm	: Minute	(00-59)	ss	: Second	(00-59)

Possible value:

YYYY	: (2000-2036)	MM	: (01-12)
DD	: (01-31)	hh	: (00-23)
mm	: (00-59)	ss	: (00-59)

Example:

```
GEFXL2P-SW24(time)# set manual 2004/12/23 16:18:00
```

set ntp**Syntax:**

```
set ntp <ip> <timezone>
```

Description:

To set up the current time via NTP server.

Argument:

<ip>: ntp server ip address or domain name
<timezone>: time zone (GMT), range: -12 to +13

Possible value:

<timezone>: -12,-11...,0,1...,13

Example:

```
GEFXL2P-SW24(time)# set ntp clock.via.net 8
Synchronizing...(1)
Synchronization success
```

show**Syntax:**

```
show
```

Description:

To show the time configuration, including "Current Time", "NTP Server", "Timezone", "Daylight Saving", "Daylight Saving Start" and "Daylight Saving End"

Argument:

None.

Possible value:

None.

Example:

```
GEFXL2P-SW24(time)# show
Current Time           : Thu Thu 14 15:04:03 2005
NTP Server             : 209.81.9.7
Timezone               : GMT+8:00
Day light Saving       : 0 Hours
Day light Saving Start : Mth: 1 Day: 1 Hour: 0
Day light Saving End   : Mth: 1 Day: 1 Hour: 0
GEFXL2P-SW24(time)#
```

■ trunk***del trunk*****Syntax:**

```
del trunk <port-range>
```

Description:

To delete the trunking port.

Argument:

<port-range>: port range, syntax 1,5-7, available from 1 to 24

Possible value:

<port-range>: 1 to 24

Example:

```
GEFXL2P-SW24(trunk)# del trunk 1
```

set priority**Syntax:**

```
set priority <range>
```

Description:

To set up the LACP system priority.

Argument:

<range>: available from 1 to 65535.

Possible value:

<range>: 1 to 65535, default: 32768

Example:

```
GEFXL2P-SW24(trunk)# set priority 33333
```

set trunk**Syntax:**

```
set trunk <port-range> <method> <group> <active LACP>
```

Description:

To set up the status of trunk, including the group number and mode of the trunk as well as LACP mode.

Argument:

<port-range> : port range, syntax 1,5-7, available from 1 to 24

<method>:

static : adopt the static link aggregation

lacp : adopt the dynamic link aggregation- link aggregation control protocol

<group>: 1-8.

<active LACP>:
active : set the LACP to active mode
passive : set the LACP to passive mode

Possible value:

<port-range> : 1 to 24
<method>: static / lacp
<group>: 1-8.
<active LACP>: active / passive

Example:

GEFXL2P-SW24(trunk)# set trunk 1-4 lacp 1 active

show aggtr-view

Syntax:

show aggtr-view

Description:

To display the aggregator list.

Argument:

None.

Possible value:

None.

Example:

GEFXL2P-SW24(trunk)# show aggtr-view

Aggregator 1) Method: None
Member Ports: 1
Ready Ports:1

Aggregator 2) Method: LACP
Member Ports: 2
Ready Ports:

: :

show lacp-detail

Syntax:

show lacp-detail <aggtr>

Description:

To display the detailed information of the LACP trunk group.

Argument:

<aggtr>: aggregator, available from 1 to 24

Possible value:

<aggtr>: 1 to 24

Example:

GEFXL2P-SW24(trunk)# show lacp-detail 2

Aggregator 2 Information:

Actor		Partner	
System Priority	MAC Address	System Priority	MAC Address
32768	00-40-c7-e8-00-02	32768	00-00-00-00-00-00

Port	Key	Trunk Status	Port	Key
2	257	---	2	0

show lacp-priority

Syntax:

show lacp-priority

Description:

To display the value of LACP Priority.

Argument:

None.

Possible value:

None.

Example:

GEFXL2P-SW24(trunk)# show lacp-priority
LACP System Priority : 32768

show status

Syntax:

show status

Description:

To display the aggregator status and the settings of each port.

Argument:

None.

Possible value:

None.

Example:

GEFXL2P-SW24(trunk)# show status

Trunk Port Setting				Trunk Port Status	
port	Method	Group	Active LACP	Aggtregator	Status
1	None	0	Active	1	Ready
2	LACP	1	Active	2	---
3	LACP	1	Active	3	---
4	LACP	1	Active	4	---
5	LACP	1	Active	5	---
6	LACP	1	Active	6	---
7	LACP	1	Active	7	---
			:		
19	None	0	Active	19	---
20	None	0	Active	20	---
21	None	0	Active	21	---
22	None	0	Active	22	---
23	None	0	Active	23	---
24	None	0	Active	24	---

■ vlan

del port-group

Syntax:

del port-group <name>

Description:

To delete the port-based vlan group.

Argument:

<name>: which vlan group you want to delete.

Possible value:

<name>: port-vlan name

Example:

GEFXL2P-SW24(vlan)# del port-group VLAN-2

del tag-group

Syntax:

del tag-group <vid>

Description:

To delete the tag-based vlan group.

Argument:

<vid>: which vlan group you want to delete, available from 1 to 4094

Possible value:

<vid>: 1 to 4094

Example:

GEFXL2P-SW24(vlan)# del tag-group 2

disable drop-untag

Syntax:

disable drop-untag <range>

Description:

Don't drop the untagged frames.

Argument:

<range> : which port(s) you want to set, syntax 1,5-7, available from 1 to 24

Possible value:

<range>: 1 to 24

Example:

GEFXL2P-SW24(vlan)# disable drop-untag 5-10

disable sym-vlan

Syntax:

disable sym-vlan <range>

Description:

To drop frames from the non-member port.

Argument:

<range>: which port(s) you want to set, syntax 1,5-7, available from 1 to 24

Possible value:

<range>: 1 to 24

Example:

GEFXL2P-SW24(vlan)# disable sym-vlan 5-10

enable drop-untag

Syntax:

enable drop-untag <range>

Description:

To drop the untagged frames.

Argument:

<range>: which port(s) you want to set, syntax 1,5-7, available from 1 to 24

Possible value:

<range>: 1 to 24

Example:

GEFXL2P-SW24(vlan)# enable drop-untag 5-10

enable sym-vlan

Syntax:

enable sym-vlan <range>

Description:

To drop frames from the non-member port.

Argument:

<range> : which port(s) you want to set, syntax 1,5-7, available from 1 to 24

Possible value:

<range>: 1 to 24

Example:

GEFXL2P-SW24(vlan)# enable sym-vlan 5-10

set mode

Syntax:

set mode < port | tag > [up-link]

Description:

To set switch VLAN mode, including port-based and tag-based modes.

Argument:

<tag>: set tag-based vlan

<port>: set port-based vlan

Possible value:

< port | tag >: port,tag

Example:

```
GEFXL2P-SW24(vlan)# set mode
```

```
Usage: set mode <port|tag>
```

```
tag: set tag-based vlan
```

```
port: set port-based vlan
```

```
GEFXL2P-SW24(vlan)#
```

set double-tag

Syntax:

set double-tag <range> <0|1|2>

Description:

To set double-tag per port and enable Q-in-Q VLAN function on switch.

Argument:

<range >: 1,5-7, available from 1 to 24

0: disable

1: service provider port

2: customer port

Possible value:

<range>: 1 to 24

Example:

```
GEFXL2P-SW24(vlan)#set double-tag 3 1
```

```
GEFXL2P-SW24(vlan)#
```

set port-group

Syntax:

set port-group <name> <range>

Description:

To add or edit a port-based VLAN group.

Argument:

<name>: port-vlan name

<range>: syntax 1,5-7, available from 1 to 24

Possible value:

<range>: 1 to 24

Example:

```
GEFXL2P-SW24(vlan)# set port-group VLAN-1 2-5, 6, 15-13
```

set port-role

Syntax:

set port-role <range> <access|trunk|hybrid> [vid]

Description:

To set egress rule: configure the port roles.

Argument:

<range> :which port(s) you want to set, syntax 1,5-7, available from 1 to 24

<access>: Do not tag frames

<trunk>: Tag all frames

<hybrid>: Tag all frames except a specific VID

<vid>: untag-vid for hybrid port

Possible value:

<range>: 1 to 24

<vid>: 1 to 4094

Example:

```
GEFXL2P-SW24(vlan)# set port-role 5 hybrid 6
```

set pvid

Syntax:

set pvid <range> <pvid>

Description:

To set the pvid of vlan.

Argument:

<range>: which port(s) you want to set PVID(s), syntax 1,5-7, available from 1 to 24

<pvid>: which PVID(s) you want to set, available from 1 to 4094

Possible value:

<range>: 1 to 24

<pvid>: 1 to 4094

Example:

```
GEFXL2P-SW24(vlan)# set pvid 3,5,6-8 5
```

set tag-group

Syntax:

set tag-group <vid> <name> <range> <#>

Description:

To add or edit the tag-based vlan group.

Argument:

<vid>: vlan ID, range from 1 to 4094

<name>: tag-vlan name

<range>: vlan group members, syntax 1,5-7, available from 1 to 24

<#>: sym/asym vlan setting. 1: symmetric vlan, 0: asymmetric vlan

Possible value:

<vid>: 1 to 4094

<range>: 1 to 24

<#>: 0 or 1

Example:

```
GEFXL2P-SW24(vlan)# set tag-group 2 VLAN-2 2-5,6,15-13 0
```

show group

Syntax:

show group

Description:

To display the vlan mode and vlan group.

Argument:

None.

Possible value:

None.

Example:

```
GEFXL2P-SW24(vlan)# show group
```

Vlan mode is double-tag.

- 1) Vlan Name : default
Vlan ID : 1
Sym-vlan : Disable
Member : 1 2 3 4 5 6 7 8 9 10 11 12 13 14 15 16

- 2) Vlan Name : VLAN-2
Vlan ID : 2
Sym-vlan : Disable
Member : 2 3 4 5 6 13 14 15

show port

Syntax:

show port

Description:

To display pvid, ingress/egress rule.

Argument:

None.

Possible value:

None.

Example:

GEFXL2P-SW24(vlan)# show pvid

Port	PVID	Rule1	Rule2	Port Rule	Untag Vid
1	1	Disable	Disable	Access	-
2	1	Disable	Disable	Access	-
3	5	Disable	Disable	Access	-
4	1	Disable	Disable	Access	-
5	5	Enable	Disable	Hybrid	6
6	5	Enable	Disable	Access	-
7	5	Enable	Disable	Access	-
8	5	Enable	Disable	Access	-
9	1	Enable	Disable	Access	-
10	1	Enable	Disable	Access	-
11	1	Disable	Disable	Access	-
			:		
			:		
23	1	Disable	Disable	Access	-
24	1	Disable	Disable	Access	-

5. Maintenance

5-1. Resolving No Link Condition

The possible causes for a no link LED status are as follows:

- The attached device is not powered on
- The cable may not be the correct type or is faulty
- The installed building premise cable is faulty
- The port may be faulty

5-2. Q&A

1. Computer A can connect to Computer B, but cannot connect to Computer C through the Managed Switch.
 - ✓ The network device of Computer C may fail to work. Please check the link/act status of Computer C on the LED indicator. Try another network device on this connection.
 - ✓ The network configuration of Computer C may be something wrong. Please verify the network configuration on Computer C.
2. The uplink connection function fails to work.
 - ✓ The connection ports on another must be connection ports. Please check if connection ports are used on that Managed Switch.
 - ✓ Please check the uplink setup of the Managed Switch to verify the uplink function is enabled.
3. The console interface cannot appear on the console port connection.
 - ✓ The COM port default parameters are [Baud Rate: 115200, Data Bits: 8, Parity Bits: None, Stop Bit: A, Flow Control: None]. Please check the COM port property in the terminal program. And if the parameters are changed, please set the COM configuration to the new setting.
 - ✓ Check the RS-232 cable is connected well on the console port of the Managed Switch and COM port of PC.
 - ✓ Check if the COM of the PC is enabled.
4. How to configure the Managed Switch?
 - ✓ The "Hyperterm" is the terminal program in Win95/98/NT. Users can also use any other terminal programs in Linux/Unix to configure the Managed Switch. Please refer to the user guide of that terminal program. But the COM port parameters (baud rate/ data bits/ parity bits/ flow control) must be the same as the setting of the console port of the Managed Switch.

Appendix A

Technical Specifications

Features

- 16 fiber (SFP) switching ports are compliant with SX/LX..etc-LC.
- 8 Gigabit TP/SFP fiber are dual media ports with auto detected function.
- Non-blocking store-and-forward shared-memory Web-Smart switched.
- Supports auto-negotiation for configuring speed, duplex mode.
- Supports 802.3x flow control for full-duplex ports.
- Supports collision-based and carrier-based backpressure for half-duplex ports.
- Any ports can be in disable mode, force mode or auto-polling mode.
- Supports Head of Line (HOL) blocking prevention.
- Supports broadcast storm filtering.
- Auto-aging with programmable inter-age time.
- Supports 802.1p Class of Service with 2-level priority queuing.
- Supports port sniffer function
- Programmable maximum Ethernet frame length of range from 1518 to 9600 bytes jumbo frame.
- Supports port-based VLAN, 802.1Q tag-based VLAN.
- Efficient self-learning and address recognition mechanism enables forwarding rate at wire speed.
- Web-based management provides the ability to completely manage the switch from any web browser.
- Support Power Saving with "ActiPHY Power Management" and "PerfectReach Power Management" techniques.
- Support Link Layer Discovery Protocol (LLDP)
- SNMP/Telnet interface delivers complete in-band management.
- Supports IEEE 802.1d Spanning Tree Protocol.
- Supports IEEE 802.1w Rapid Spanning Trees.
- Supports IEEE 802.1s Multiple Spanning Trees.
- Supports IEEE 802.1X port-based network access control.
- Supports ACL to classify the ingress packets to do permit/deny, rate limit actions
- Supports QCL to classify the ingress packets for priority queues assignment
- Supports IP-MAC Binding function to prevent spoofing attack
- Supports IP Multicasting to implement IGMP Snooping function.
- Supports 802.1p Class of Service with 4-level priority queuing.
- Supports 802.3ad port trunking with flexible load distribution and failover function.
- Supports ingress port security mode for VLAN Tagged and Untagged frame process.
- Supports SNMP MIB2 and RMON sampling with sampled packet error indication.

Hardware Specifications

- **Standard Compliance:** IEEE802.3/802.3ab / 802.3z / 802.3u / 802.3x
- **Network Interface:**

Configuration	Mode	Connector	Port
10/100/1000Mbps Gigabit TP	NWay	TP (RJ-45)	1 - 8
1000Base-SX Gigabit Fiber	1000 FDX	*SFP	1-24(Optional)
1000Base-LX Gigabit Fiber	1000 FDX	*SFP	1-24(Optional)
1000Base-LX Single Fiber WDM (BiDi)	1000 FDX	*SFP	1-24(Optional)

*Port 1, 8 are TP/SFP fiber dual media ports with auto detected function

*Optional SFP module supports LC or BiDi LC transceiver

- **Transmission Mode:** 10/100Mbps support full or half duplex
1000Mbps support full duplex only
- **Transmission Speed:** 10/100/1000Mbps for TP
1000Mbps for Fiber
- **Full Forwarding/Filtering Packet Rate:** PPS (packets per second)

Forwarding Rate	Speed
1,488,000PPS	1000Mbps
148,800PPS	100Mbps
14,880PPS	10Mbps

- **MAC Address and Self-learning:** 8K MAC address
4K VLAN table entries,
- **Buffer Memory:** Embedded 1392 KB frame buffer
- **Flow Control:** IEEE802.3x compliant for full duplex
Backpressure flow control for half duplex
- **Cable and Maximum Length:**

TP	Cat. 5 UTP cable, up to 100m
1000Base-SX	Up to 220/275/500/550m, which depends on Multi-Mode Fiber type
1000Base-LX	Single-Mode Fiber, up to 10/30/50Km
1000Base-LX WDM (BiDi)	Single-Mode Single Fiber, up to 20Km

- **Diagnostic LED:**

System LED :	Power
Per Port LED:	
10/100/1000M TP Port 1 to 8	: LINK/ACT, 10/100/1000Mbps
1000M SFP Fiber Port 1 to 24	: SFP(LINK/ACT)

- **Power Requirement** : AC Line
- Voltage : 100~240 V

- Frequency : 50~60 Hz
- Consumption : 30W
- **Ambient Temperature** : 0° to 40°C
- **Humidity** : 5% to 90%
- **Dimensions** : 44(H) × 442(W) × 209(D) mm
- **Comply with FCC Part 15 Class A & CE Mark Approval**

Management Software Specifications

System Configuration	Auto-negotiation support on 10/100/1000 Base-TX ports, Web browser or console interface can set transmission speed (10/100/1000Mbps) and operation mode (Full/Half duplex) on each port, enable/disable any port, set VLAN group, set Trunk Connection.
Management Agent	SNMP support; MIB II, Bridge MIB, RMON MIB
Spanning Tree Algorithm	IEEE 802.1D
VLAN Function	Port-Base / 802.1Q-Tagged, allowed up to 256 active VLANs in one switch.
Trunk Function	Ports trunk connections allowed
IGMP	IP Multicast Filtering by passively snooping on the IGMP Query.
Bandwidth Control	Supports by-port Egress/Ingress rate control
Quality of Service (QoS)	Referred as Class of Service (CoS) by the IEEE 802.1P standard ,Classification of packet priority can be based on either a VLAN tag on packet or a user-defined Per port QoS. Two queues per port IP TOS Classification TCP/UDP Port Classification IP DiffServe Classification
Port Security	Limit number of MAC addresses learned per port static MAC addresses stay in the filtering table.
Internetworking Protocol	Bridging : 802.1D Spanning Tree IP Multicast : IGMP Snooping IP Multicast Packet Filtering Maximum of 256 active VLANs and IP multicast sessions
Network Management	One RS-232 port as local control console Telnet remote control console SNMP agent : MIB-2 (RFC 1213) Bridge MIB (RFC 1493) RMON MIB (RFC 1757)-statistics Ethernet-like MIB (RFC 1643) Web browser support based on HTTP Server and CGI parser TFTP software-upgrade capability.

Note: Any specification is subject to change without notice.

Appendix B

Null Modem Cable Specifications

The DB-9 cable is used for connecting a terminal or terminal emulator to the Managed Switch's RS-232 port to access the command-line interface.

The table below shows the pin assignments for the DB-9 cable.

Function	Mnemonic	Pin
Carrier	CD	1
Receive Data	RXD	2
Transmit Data	TXD	3
Data Terminal Ready	DTR	4
Signal Ground	GND	5
Data Set Ready	DSR	6
Request To Send	RTS	7
Clear To Send	CTS	8

9 Pin Null Modem Cable

CD	1	_____	4	DTR
DSR	6	_____	1	CD
DTR	4	_____	6	DSR
RXD	2	_____	3	TXD
TXD	3	_____	2	RXD
GND	5	_____	5	GND
RTS	7	_____	8	CTS
CTS	8	_____	7	RTS
Reserve	9	_____	9	Reserve